

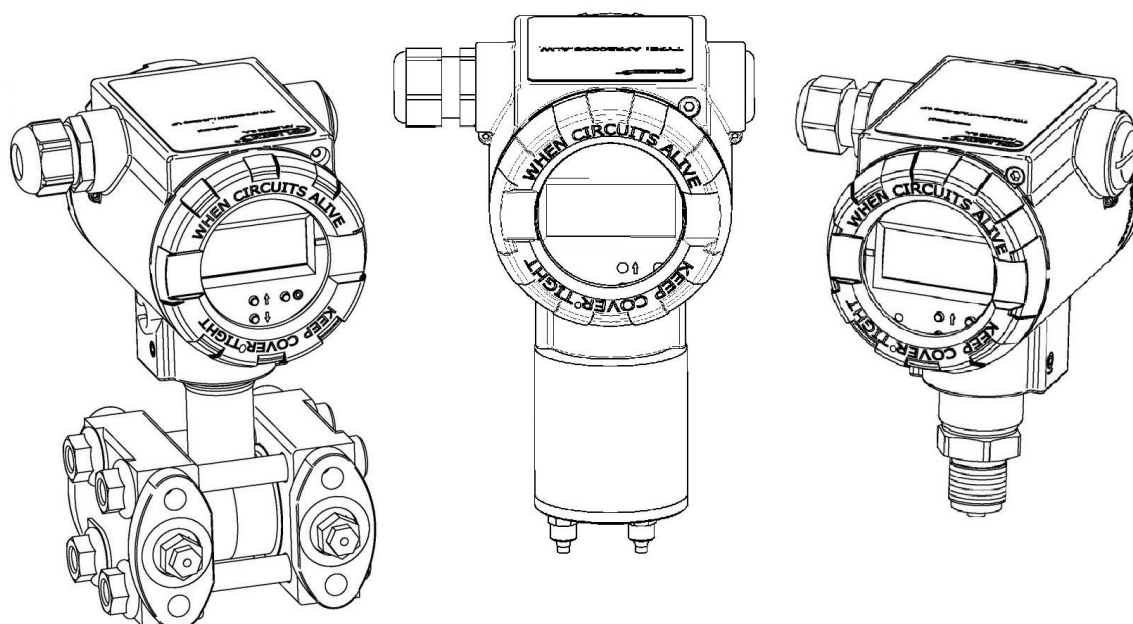

USER'S MANUAL

PRESSURE AND DIFFERENTIAL PRESSURE TRANSMITTERS

**APC-2000ALW, APR-2000ALW, APR-2000ALW/G,
APR-2000ALW with diaphragm seals**



PRODUCT CODE – see: (→ [Transmitter identification](#)).

The QR code or ID number identifies the transmitter and provides quick access to the following documentation on the manufacturer's website: user's manual, explosion-proof device user manual, technical information, declarations of conformity and copies of certificates.

APC-2000ALW

ID:0005 0007 0004 0000 0000 0000 0001 30

ID:0005 0007 0005 0000 0000 0000 0001 05

<https://aplisens.pl/ID/0005000700050000000000000000105/00000000>

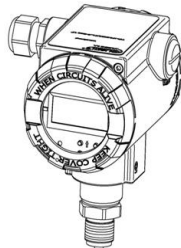

APC-2000ALW (Exi)

ID:0005 0007 0004 0000 0000 0001 0001 78

ID:0005 0007 0005 0000 0000 0001 0001 53

<https://aplisens.pl/ID/00050007000500000000000000001000153/00000000>

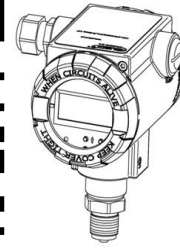

APC-2000ALW (Exd)

ID:0005 0008 0002 0000 0000 0002 0001 48

ID:0005 0008 0006 0000 0000 0002 0001 45

<https://aplisens.pl/ID/00050008000600000000000000002000145/00000000>

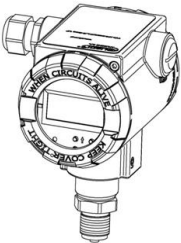

APC-2000ALW (Exi/Exd)

ID:0005 0004 0002 0000 0000 0002 0001 75

ID:0005 0004 0006 0000 0000 0002 0001 72

<https://aplisens.pl/ID/00050004000600000000000000002000172/00000000>

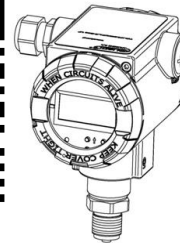

APC-2000ALW (For sea uses)

ID:0005 0007 0004 0000 0000 0003 0001 77

ID:0005 0007 0005 0000 0000 0003 0001 52

<https://aplisens.pl/ID/00050007000500000000000000003000152/00000000>



APC-2000ALW (Exi) (For sea uses)

ID:0005 0007 0004 0000 0000 0004 0001 28

ID:0005 0007 0005 0000 0000 0004 0001 03

<https://aplisens.pl/ID/00050007000500000000000000004000103/00000000>

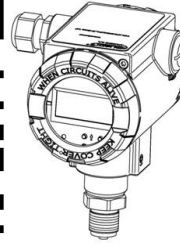

APC-2000ALW (Exd) (For sea uses)

ID:0005 0008 0002 0000 0000 0005 0001 95

ID:0005 0008 0006 0000 0000 0005 0001 92

<https://aplisens.pl/ID/00050008000600000000000000005000192/00000000>

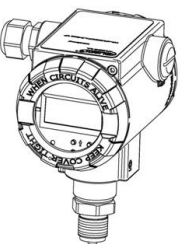

APR-2000ALW

ID:0006 0007 0004 0000 0000 0000 0001 27
ID:0006 0007 0005 0000 0000 0000 0001 02
<https://aplisens.pl/ID/0006000700050000000000000102/00000000>

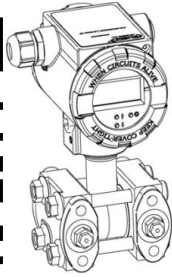

APR-2000ALW (Exi)

ID:0006 0007 0004 0000 0000 0001 0001 75
ID:0006 0007 0005 0000 0000 0001 0001 50
<https://aplisens.pl/ID/000600070005000000000001000150/00000000>



APR-2000ALW (Exd)

ID:0006 0008 0002 0000 0000 0002 0001 45
ID:0006 0008 0006 0000 0000 0000 0001 42
<https://aplisens.pl/ID/000600080006000000000002000142/00000000>

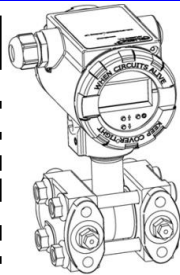

APR-2000ALW (Exi/Exd)

ID:0006 0004 0002 0000 0000 0002 0001 72
ID:0006 0004 0006 0000 0000 0000 0001 69
<https://aplisens.pl/ID/000600040006000000000002000169/00000000>



APR-2000ALW (For sea uses)

ID:0006 0007 0004 0000 0000 0003 0001 74
ID:0006 0007 0005 0000 0000 0003 0001 49
<https://aplisens.pl/ID/000600070005000000000003000149/00000000>

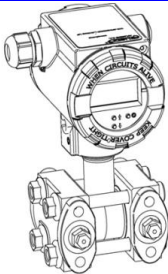

APR-2000ALW (Exi) (For sea uses)

ID:0006 0007 0004 0000 0000 0004 0001 25
ID:0006 0007 0005 0000 0000 0004 0001 97
<https://aplisens.pl/ID/000600070005000000000004000197/00000000>

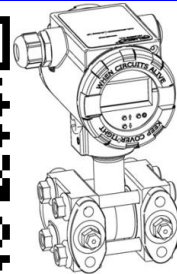

APR-2000ALW (Exd) (For sea uses)

ID:0006 0008 0002 0000 0000 0005 0001 92
ID:0006 0008 0006 0000 0000 0005 0001 89
<https://aplisens.pl/ID/000600080006000000000005000189/00000000>

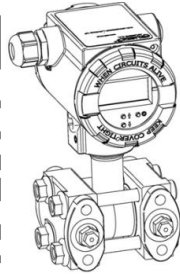

APR-2000ALW/G

ID:0008 0007 0004 0000 0000 0000 0001 21

ID:0008 0007 0005 0000 0000 0000 0001 93

<https://aplisens.pl/ID/000800070005000000000000000193/00000000>

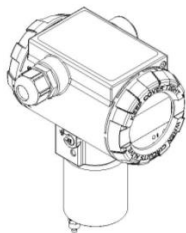

APR-2000ALW/G (Exi)

ID:0008 0007 0004 0000 0000 0001 0001 69

ID:0008 0007 0005 0000 0000 0001 0001 44

<https://aplisens.pl/ID/00080007000500000000000001000144/00000000>

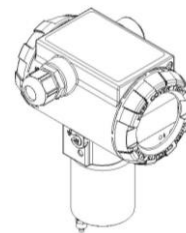

APR-2000ALW/G (Exd)

ID:0008 0008 0002 0000 0000 0002 0001 39

ID:0008 0008 0006 0000 0000 0002 0001 36

<https://aplisens.pl/ID/00080008000600000000000002000136/00000000>

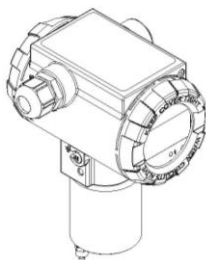

APR-2000ALW/G (Exi/Exd)

ID:0008 0004 0002 0000 0000 0002 0001 66

ID:0008 0004 0006 0000 0000 0002 0001 63

<https://aplisens.pl/ID/00080004000600000000000002000163/00000000>

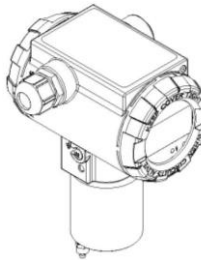

APR-2000ALW with diaphragm seals

ID:0007 0007 0004 0000 0000 0000 0001 24

ID:0007 0007 0005 0000 0000 0000 0001 96

<https://aplisens.pl/ID/000700070005000000000000000196/00000000>

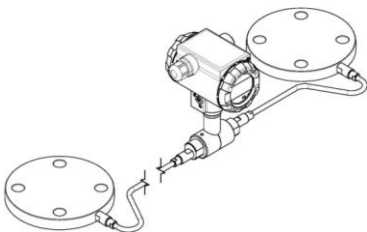

APR-2000ALW (Exi) with diaphragm seals

ID:0007 0007 0004 0000 0000 0001 0001 72

ID:0007 0007 0005 0000 0000 0001 0001 47

<https://aplisens.pl/ID/00070007000500000000000001000147/00000000>

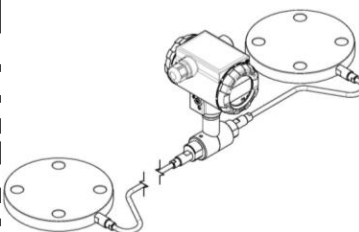

APR-2000ALW (Exd) with diaphragm seals

ID:0007 0008 0002 0000 0000 0002 0001 42

ID:0007 0008 0006 0000 0000 0002 0001 39

<https://aplisens.pl/ID/00070008000600000000000002000139/00000000>

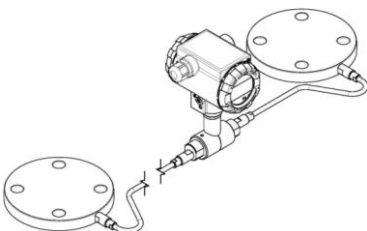

APR-2000ALW (Exi/Exd) with diaphragm seals



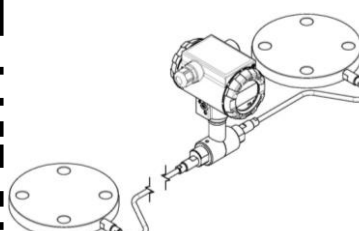

ID:0007 0004 0002 0000 0000 0002 0001 69

ID:0007 0004 0006 0000 0000 0002 0001 66

<https://aplisens.pl/ID/00070004000600000000000002000166/00000000>



Symbols used

Symbol	Description
	Warning to proceed strictly in accordance with the information contained in the documentation in order to ensure the safety and full functionality of the device.
	Information particularly useful during installation and operation of the device.
	Information particularly useful during installation and operation of an Ex type device.
	Information on disposal of used equipment.

BASIC REQUIREMENTS AND SAFE USE



The manufacturer will not be liable for damage resulting from incorrect installation, failure to maintain a suitable technical condition of the device or use of the device other than for its intended purpose.

Installation should be carried out by qualified staff having the required authorizations to install electrical and I&C equipment. The installer is responsible for performing the installation in accordance with manual as well as with the electromagnetic compatibility and safety regulations and standards applicable to the type of installation.

In systems with I&C equipment, in case of leakage, there is a danger to staff due to the medium under pressure. All safety and protection requirements must be observed during installation, operation and inspections.

If a malfunction occurs, the device should be disconnected and handed over to the manufacturer for repair.



In order to minimize the risk of malfunction and associated risks to staff, the device is not to be installed or used in particularly unfavourable conditions, where the following hazards occur:

- possible mechanical impacts, excessive shocks and vibration;
- excessive temperature fluctuation;
- water vapour condensation, dusting, icing.

Changes made to the manufacturing of products may be introduced before the paper version of the manual is updated. The up-to-date manuals are available on the manufacturer's website: www.aplisens.com.

TABLE OF CONTENTS

1. INTRODUCTION	9
1.1. Purpose of the document	9
1.2. Trademarks	9
1.3. Definitions and abbreviations	10
1.4. Transmitter set range	11
2. SAFETY	12
3. TRANSPORT AND STORAGE	13
3.1. Delivery check	13
3.2. Transport	13
3.3. Storage	13
4. GUARANTEE	13
5. IDENTIFICATION	14
5.1. Manufacturer's address	14
5.2. Transmitter identification	14
5.3. CE mark, declaration of conformity	15
6. INSTALLATION	15
6.1. General recommendations	15
6.1.1. Examples of transmitter installation	15
6.1.2. Installation instructions for transmitters with distance separators	16
7. ELECTRICAL CONNECTION	17
7.1. Cable connection to transmitter internal terminals	17
7.1.1. Cable connection	17
7.1.2. Connection of transmitter with the option of using local HART communication ..	18
7.2. Transmitter power supply	20
7.2.1. Transmitter supply voltage	20
7.2.2. Uninterruptible current measurement in 4...20 mA current loop	20
7.2.3. Specifications of electrical switching terminals	20
7.2.4. Cabling specification	20
7.2.5. Resistance load in power supply line	20
7.2.6. Shielding, equipotential bonding	21
7.3. Equipotential bonding	21
7.4. Overvoltage protection	21
7.5. Final inspection of cabling	21
8. OPERATION	22
8.1. Local buttons	26
8.2. Local configuration of setpoints	26
8.3. Navigation in local setpoints MENU	26
8.4. Acceptance of local setpoints	26
8.5. Structure of local setpoints MENU	27
8.6. Remote configuration of setpoints (HART 5/HART 7)	28
8.6.1. Compatible devices	28
8.6.2. Compatible configuration software	28
8.6.3. Local HART communication jumper	28
9. START-UP	29

9.1. Alarm configuration	29
9.2. Configuration of operating mode	31
9.3. Correction of impact of transmitter mounting position on site – pressure reset.....	32
9.4. Correction of impact of spacing of distance separators on site	32
9.5. Flow measurements	32
9.6. Level measurements	33
9.7. Pressure and differential pressure measurements	33
10. MAINTENANCE.....	34
10.1. Periodic inspections	34
10.2. Non-periodic inspections	34
10.3. Cleaning/washing	34
10.3.1. Diaphragm cleaning	34
10.4. Spare parts.....	34
10.5. Repair	34
10.6. Returns.....	34
11. SCRAPPING, DISPOSAL.....	35
12. HISTORY OF REVISIONS.....	35

LIST OF DRAWINGS

Figure 1. Set range and measurement limits.	11
Figure 2. Examples of pressure transmitter installation.....	15
Figure 3. Examples of differential pressure transmitter installation.	15
Figure 4. Examples of transmitter installation on tanks.	16
Figure 5. Electrical connection to transmitter.	17
Figure 6. Electrical connection 4...20 mA of HART to transmitter in standard version.	18
Figure 7. Electrical connection 4...20 mA of HART to transmitter in Exd version.	19
Figure 8. Electrical connection 4...20 mA of HART to transmitter in Exi version.	19
Figure 9. Rotation of the housing, change of display position and access to buttons.	22
Figure 10. Display information fields.	22
Figure 11. Set range current, saturation currents, alarm currents of transmitters in Exd or Exi/Exd (also IS, XP, IS/XP) version.	29
Figure 12. Set range current, saturation currents, alarm currents of transmitters in standard or Exi version.	30

LIST OF TABLES

Table 1. Definitions and abbreviations.....	10
Table 2. Symbols appearing on the transmitter's nameplate.	14
Table 3. Permissible transmitter supply voltages.	20

1. INTRODUCTION

1.1. Purpose of the document

The subject of manual are smart pressure transmitters **APC-2000ALW**, smart differential pressure transmitters **APR-2000ALW**, **APR-2000ALW with diaphragm seals** (formerly APR-2200ALW), **APR-2000ALW/G** (formerly APR-2000GALW), hereinafter referred jointly to as the transmitters. The manual applies to the following versions: standard, PED, flameproof Exd (XP), intrinsically safe Exi (IS) and Exi/Exd (IS/XP).

Within the meaning of Directive 2014/68/EU (PED), the transmitters are designed to category I, module A. PED marking does not apply to additional equipment of the transmitters, i.e. separators, valves, connectors, impulse tubes, etc. In the manufacturer's EU declarations of conformity, the transmitters as designed above have the CE markings. The transmitters with permissible overload of 200 bar and lower are manufactured in accordance with good engineering practice according to article 4 point 3 of Directive 2014/68/EU.

The manual contains data, tips and general recommendations for safe installation and operation of the transmitters, as well as troubleshooting in case of possible failure.

The manual does not cover explosion protection issues.



The use of the equipment in hazardous zones without appropriate approvals is forbidden. It is mandatory to read EN.IX.APC.APR.ALW Explosion-proof Device User Manual, containing important information related to the installation of intrinsically safe and flameproof versions of the transmitters.



The use of the equipment in hazardous area without appropriate approvals is forbidden. It is mandatory to read EN.FM.APC.APR.ALW Hazardous Area Installation Manual, containing important information related to the installation of intrinsically safe (IS) and explosionproof versions (XP) of the transmitters.

In addition, please refer to the Technical Information:

- Technical Information contains detailed technical data, parameters and recommendations for installation and operation.

1.2. Trademarks

HART® is a registered trademark of FieldComm Group.

Windows® is a registered trademark of Microsoft Corporation.

Google Play® is a service registered and managed by Google® Inc.

1.3. Definitions and abbreviations

Table 1. Definitions and abbreviations.

Item no.	Abbr.	Meaning
1	LRV	"Lower Range Value" – the value of the set range expressed in physical units corresponding to the current of 4,000 mA, i.e. 0% of the output setpoint. The set range cannot exceed the set range limits. The minimum width of the set range [(URV-LRV)] is limited to 10% of the base range (URL-LRL) .
2	URV	"Upper Range Value" – the value of the set range expressed in physical units corresponding to the current of 20,000 mA, i.e. 100% of the output setpoint. The set range cannot exceed the set range limits. The minimum width of the set range [(URV-LRV)] is limited to 10% of the base range (URL-LRL) .
3	LRL LSL	"Lower Range Limit" or "Lower Sensor Limit" - lower limit of set range expressed in physical units. Value (URL-LRL) or (USL-LSL) is referred to as the base transmitter range.
4	URL USL	"Upper Range Limit" or "Upper Sensor Limit" – upper limit of set range expressed in physical units. Value (URL-LRL) or (USL-LSL) is referred to as the base transmitter range.
5	LPL	"Lower Processing Limit" – lower limit of digital processing of measured value. The transmitter processes a digital measurement up to 50% of the base range width below the lower limit of set range LRL (LSL) . After reaching the LPL and when below this value up to LSAL , the transmitter freezes the refreshing of digital value of the measurement. In this situation, for Exd(XP) or Exi/Exd version of transmitter, error number E0128 will be displayed on the display and diagnostic alarm mode I_AL<3,600 mA will be set. For standard or Exi transmitters, a message "UndEr" will be displayed, and diagnostic alarm mode will be activated depending on the settings I_AL<3,650 mA or I_AL>21,500 mA. Additionally, collective status PV_OUT_OF_LIMITS and status PV_LOW_LIMITED in the Transducer Block will be set, which can be read out in the diagnostic tab via HART communication.
6	UPL	"Upper Processing Limit" – upper limit of digital processing of measured value. The transmitter processes a digital measurement up to 50% of the base range width above the upper limit of set range URL (USL) . After reaching the UPL and when above this value up to USAL , the transmitter freezes the refreshing of digital value of the measurement. In this situation, for Exd or Exi/Exd (also IS, XP, IS/XP) version of transmitter, error number E0128 will be displayed on the display and diagnostic alarm mode I_AL<3,600 mA will be set. For standard or Exi transmitters, a message "OvEr" will be displayed and diagnostic alarm mode will be activated depending on the settings I_AL<3,650 mA or I_AL>21,500 mA. Additionally, collective status PV_OUT_OF_LIMITS and status PV_HIGH_LIMITED in the Transducer Block will be set, which can be read out in the diagnostic tab via HART communication.
7	LSAL	"Lower Saturation Limit" - lower limit of the A/D transmitter processing range. The lower limit of the A/D transmitter saturation is on the pressure/differential pressure scale below the LPL point and is associated with the minimum pressure, at which the analogue-digital pressure measurement transmitter reaches the lower limit of the processing capacity. The exact determination of this pressure is not possible, however usually the pressure does not exceed the pressure corresponding to 200% of the base range width (URL-LRL) below the lower limit of the digital processing of measured LPL value. After reaching LSAL and when below this value, error number E0136 will be displayed on the display and the diagnostic alarm mode I_AL<3,600 mA will be activated (applies to Exd or Exi/Exd (also IS, XP, IS/XP) version of transmitter). For standard or Exi transmitters, error number E0256 will be displayed and diagnostic alarm mode will be activated depending on the settings I_AL<3,650 mA or I_AL>21,500 mA. Additionally, collective status SENSOR_FAULT, PV_OUT_OF_LIMITS, status NOREF+ERR@AIN1_AD7794 in the Sensor Block and PV_LOW_LIMITED in the Transducer Block will be set, which can be read out in the diagnostic tab via HART communication.
8	USAL	"Upper Saturation Limit" - upper limit of the A/D transmitter processing range. The upper limit saturation point of A/D transmitter is on the pressure/differential pressure scale above the UPL point and is associated with the maximum pressure at which the analogue-digital pressure measurement transmitter reaches the upper limit of the processing capacity. The exact determination of this pressure is not possible, however usually the pressure does not exceed the pressure corresponding to 200% of the base range width (URL-LRL) above the upper limit of the digital processing of measured UPL value. After reaching USAL and when above this value, error number E0136 will be displayed on the display and the diagnostic alarm mode I_AL<3,600 mA will be activated (applies to Exd or Exi/Exd (also IS, XP, IS/XP) version of transmitter). For standard or Exi transmitters, error number E0256 will be displayed and diagnostic alarm mode will be activated depending on the settings I_AL<3,650 mA or I_AL>21,500 mA. Additionally, collective status SENSOR_FAULT, PV_OUT_OF_LIMITS, status NOREF+ERR@AIN1_AD7794 in the Sensor Block and PV_HIGH_LIMITED in the Transducer Block will be set, which can be read out in the diagnostic tab via HART communication.
9	AL_L	Low current alarm.
10	AL_H	High current alarm.
11	I_AL	The alarm current set by the transmitter controller in the current loop.

1.4. Transmitter set range

The figure below shows the transmitter set range and limits related to allowable set range, digital processing range and saturation limits of A/D pressure measurement transducer. As standard, values of 4 mA/20 mA currents are assigned to LRV/URV points. In order to obtain reverse characteristics, it is possible to reverse the assignment so that the LRV/URV points are assigned to 20 mA/4 mA currents.

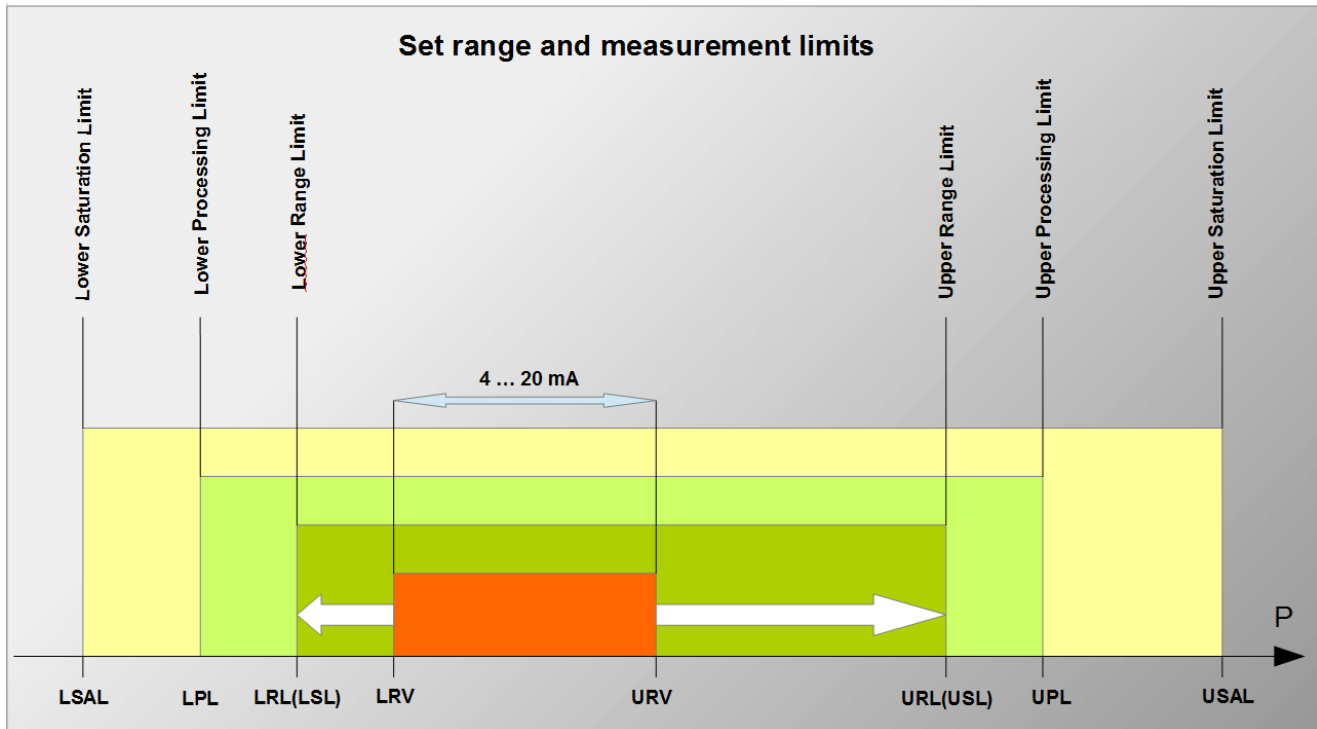

Figure 1. Set range and measurement limits.

2. SAFETY

- The installation and start-up of the device and any activities related to operation shall be carried out after thorough examination of the contents of user's manual and the instructions related thereto;
- installation and maintenance should be carried out by qualified staff having the required authorizations to install electrical and measuring devices;
- the device shall be used according to its intended purpose in line with the permissible parameters specified on the nameplate (→ [Transmitter identification](#));
- the protection elements used by the manufacturer to ensure transmitter safety may be less effective if the device is operated in a manner not consistent with its intended purpose;
- before installing or disassembling the device, it is absolutely necessary to disconnect it from the power source;
- no repairs or alterations to the transmitter electronic system are permitted. Assessment of damages and possible repair may only be performed by the manufacturer or authorized representative;
- do not use instruments if damaged. In case of malfunction, the device must be put out of operation;
- in case of transmitters equipped with factory-mounted process connector of C and CR type, it is unacceptable to loosen the fixing screws of the connector cover.



3. TRANSPORT AND STORAGE

3.1. Delivery check

After receiving the delivery of the equipment, it is necessary to:

- make sure that the packaging and its contents were not damaged during transport;
- check the completeness and correctness of the received order, and make sure no parts are missing.

3.2. Transport

Transport of transmitters shall be carried out with the use of covered means of transport, in original packages with diaphragm provided with protection. The packaging shall be protected against movement and direct impact of atmospheric factors.

3.3. Storage

Transmitters shall be stored in a factory packaging, in a room without vapours and aggressive substances, protected against mechanical impact.

Allowable range of storage temperature:

-40 ... 80°C (-40 ... 176°F).

4. GUARANTEE

General terms and conditions of guarantee are available on the manufacturer's website:

www.aplisens.com/ogolne_warunki_gwarancji



The guarantee shall be repealed if the device is used against its intended use, failure to comply with user's manual or interference with the structure of the device.

5. IDENTIFICATION









5.1. Manufacturer's address

APLISENS S.A.
03-192 Warsaw
Morelowa 7 St.
Poland

5.2. Transmitter identification

Depending on the version of the transmitter, the nameplates may differ in the amount of information and parameters.

Table 2. Symbols appearing on the transmitter's nameplate.

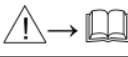
	Logo and name of manufacturer
	CE mark
	CE mark with notified number
	QR code
TYPE:	Transmitter type
Process connection:	Process connection
ID	Transmitter model ID
	Measurement range
	Permissible ambient temperature range
	Permissible static pressure
	Power supply voltage
	Output signal
Ser.- No.	Serial number
Electrical connection:	Electrical connection
Year of production	Year of production
Mat.	Material of wetted parts
IP	IP protection rating
	Note about obligation to read the manual
//Lower part of the nameplate//	Parameters in acc. with PED, Designation of the explosion-proof type certificate designation
03-192 WARSZAWA Morelowa 7 Poland tel.: +48 22 814 07 77	Manufacturer address

5.3. CE mark, declaration of conformity

The device has been designed to meet the highest safety standards, has been tested and has left the factory in a condition that is safe for operation. The device complies with the applicable standards and regulations listed in the EU Declaration of Conformity and has CE marking on nameplate.

6. INSTALLATION

6.1. General recommendations



It is recommended that in case of a gaseous medium, the transmitters should be installed above the measuring point so that condensate may flow to the point from which the measured pressure is collected, while in case of liquid medium or steam, it should be installed below the point of pressure intake. The configuration of impulse tubes and valve connection system should be selected taking into account the measurement conditions.

Differential pressure transmitters for gases APR-2000ALW/G should be obligatorily installed vertically.

6.1.1. Examples of transmitter installation

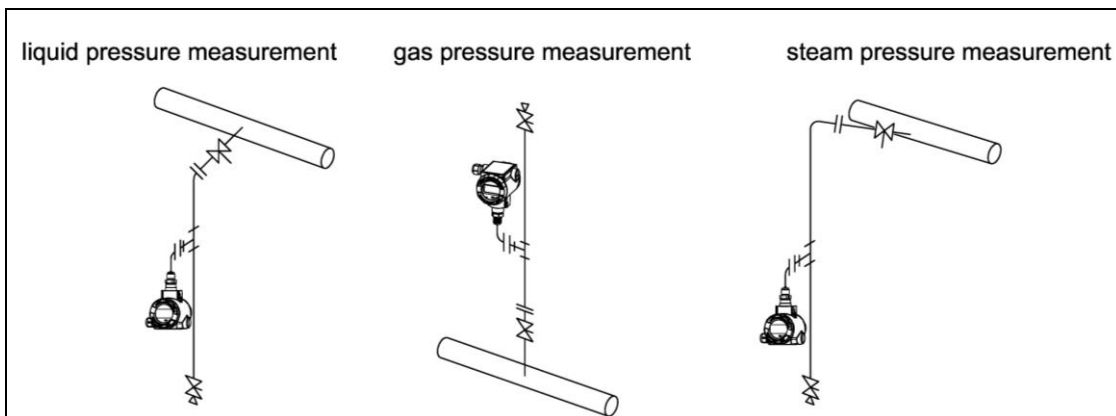

Figure 2. Examples of pressure transmitter installation.

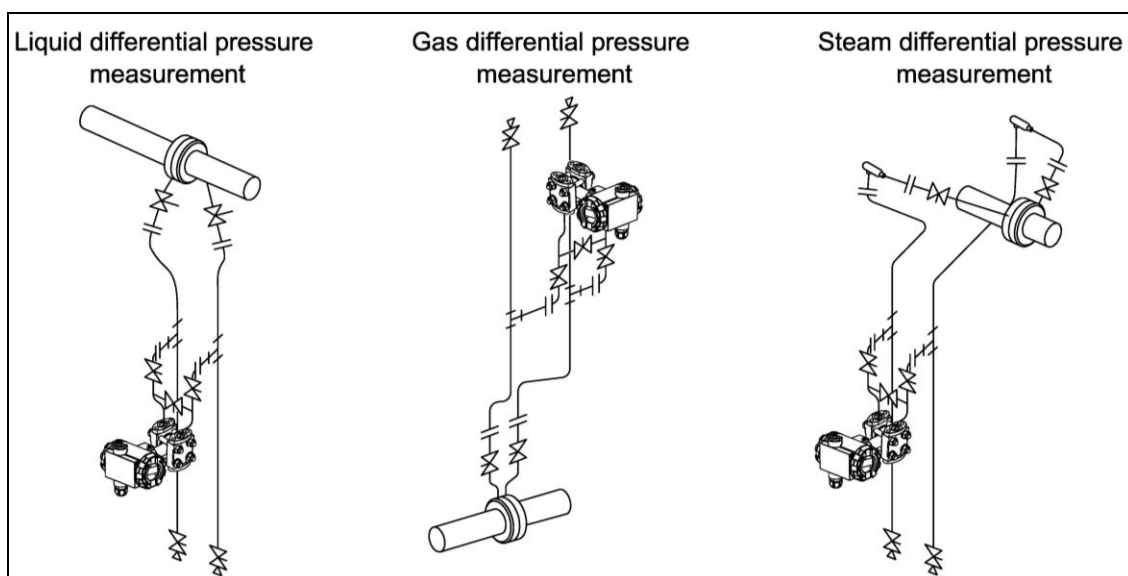

Figure 3. Examples of differential pressure transmitter installation.

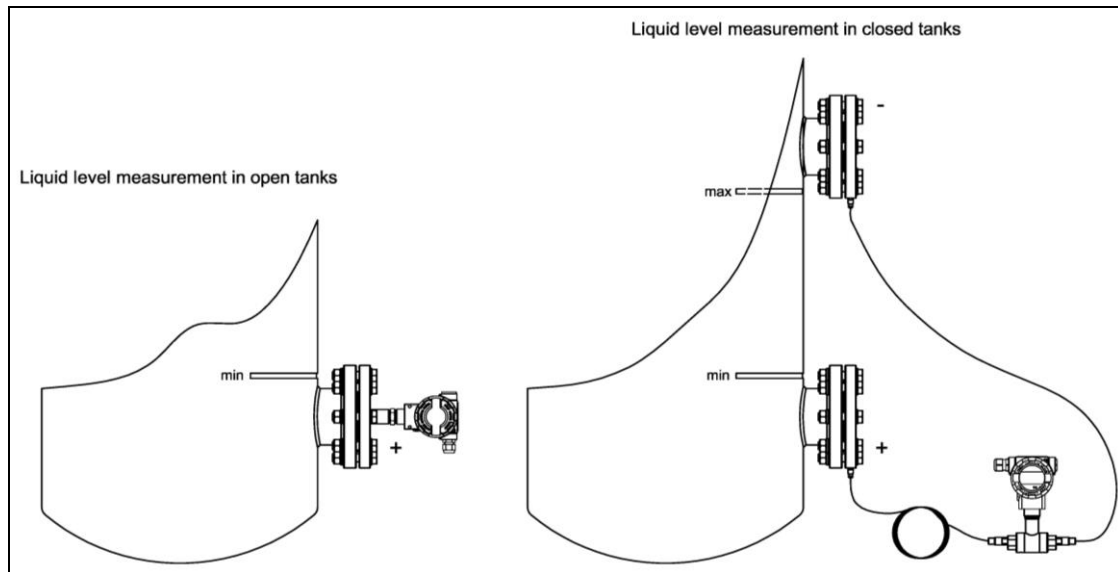

Figure 4. Examples of transmitter installation on tanks.

6.1.2. Installation instructions for transmitters with distance separators

The protection of the separator diaphragm can only be removed shortly before installation. Hydrostatic pressure of the manometric liquid column in the transmitter-separator system may cause incorrect indication of the measured value. After installation, the transmitter must be pressure-reset. Do not clean or touch separator diaphragms using hard or pointy objects.

Separators with pressure transmitter form a closed, calibrated system filled with gauge fluid. The opening for filling the device with gauge fluid is sealed and must not be opened.



When choosing a mounting location, it is necessary to ensure sufficient stress relief of the capillaries tension in order to avoid excessive bending.

Incorrect installation of the sealing may result in incorrect measurement indications.

Special attention must be paid when selecting correct dimensions of the sealing.



As standard, the separators are not provided with the gaskets.

7. ELECTRICAL CONNECTION

7.1. Cable connection to transmitter internal terminals



All connection and installation operations shall be performed with disconnected supply voltage and other external voltages, if used.



Failure to provide proper connection of the transmitter may result in danger. Risk of electric shock and/or ignition in potentially explosive atmospheres.

7.1.1. Cable connection

In order to perform correct connection of the cables, the following steps shall be performed:

- disconnect power supply of the supply cable line before connecting the transmitter cabling;
- unscrew the rear cover of the transmitter body to access the power connector;
- pull the cable through the cable gland;
- connect the transmitter according to the figure below, paying attention to the correct tightening of the bolts fixing the conductor core to the terminal;
- check the correct fixing of the HART local communication jumper;
- tighten the rear cover of the transmitter body;
- leaving a small clearance of the cable inside the body, tighten the gland nut so that the gland seal is clamped on the power cable.

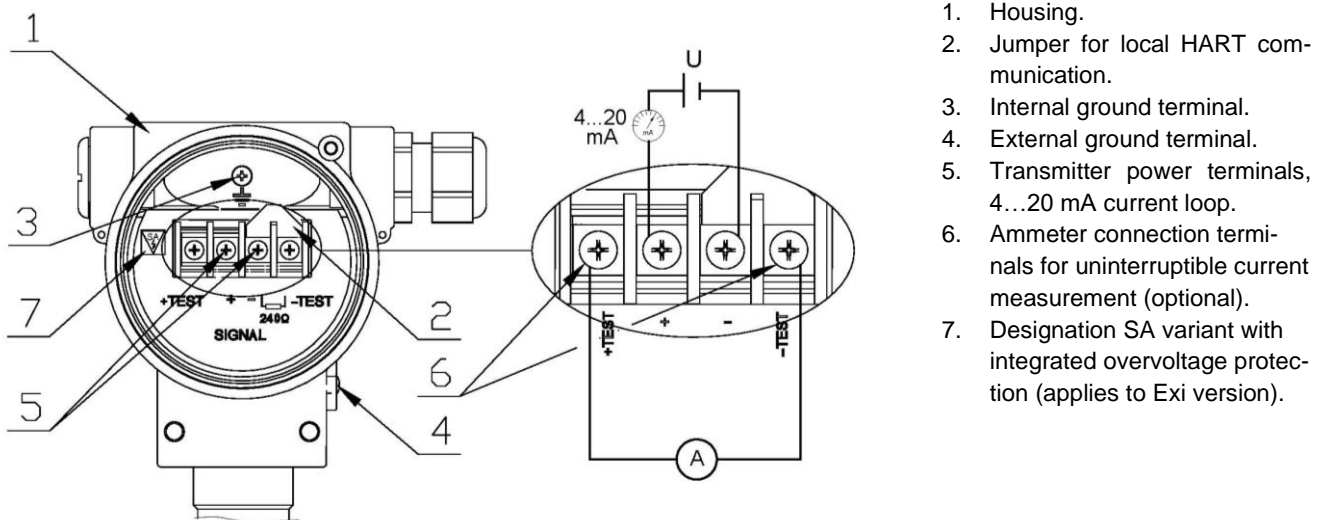

Figure 5. Electrical connection to transmitter.



In hazardous zone, do not unscrew the housing covers after connecting the Exd flameproof transmitter to the power source.

7.1.2. Connection of transmitter with the option of using local HART communication

The transmitter allows to use the local HART communication. To do this you can use a HART communicator unit or modem connected to a computer or a smartphone.

In order to establish the local communication, it is necessary to:

- remove HART communication jumper (item 2);
- connect the communicator or modem to electrical terminals (item 7).



Opening of the HART jumper results in applying resistance of $240\ \Omega$ in series in line $4\dots 20\ \text{mA}$. This resistance reduces voltage on transmitter supply terminals by approximately $5\ \text{V DC}$ for Exd or Exi/Exd transmitters ($5,28\ \text{V DC}$ for standard or Exi transmitters) for maximum current that can be set by the transmitter. **To avoid the supply voltage deficit on the transmitter terminals, the HART jumper must be dismantled only for the time of performing the HART local communication.**

Connection diagram of the communicator or modem to transmitter power supply and measurement system is presented below:

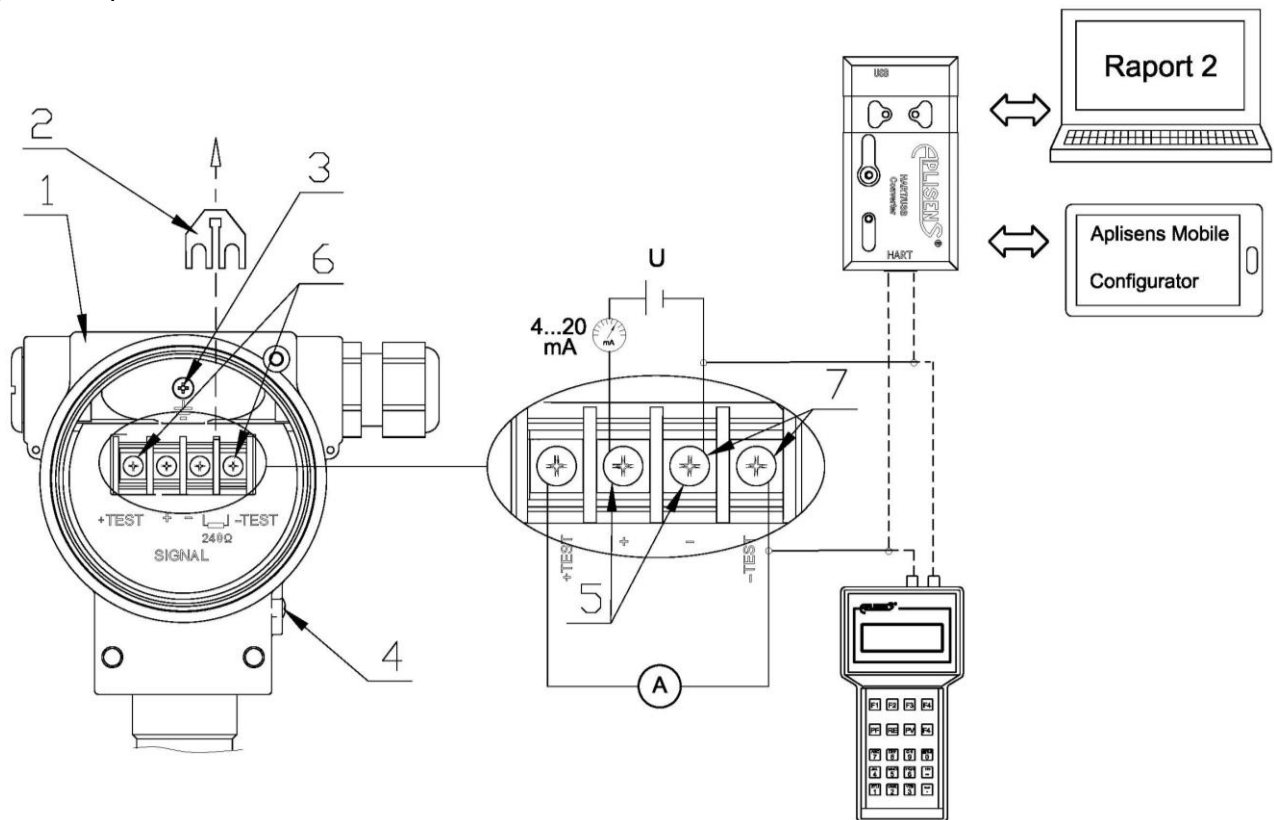

Figure 6. Electrical connection $4\dots 20\ \text{mA}$ of HART to transmitter in standard version.

1. Housing.
2. Removed local HART communication jumper.
3. Internal ground terminal.
4. External ground terminal.
5. Transmitter power terminals, $4\dots 20\ \text{mA}$ current loop.
6. Ammeter connection terminals for uninterruptible current measurement (optional).
7. Terminals – point of connection of the communicator or HART modem.

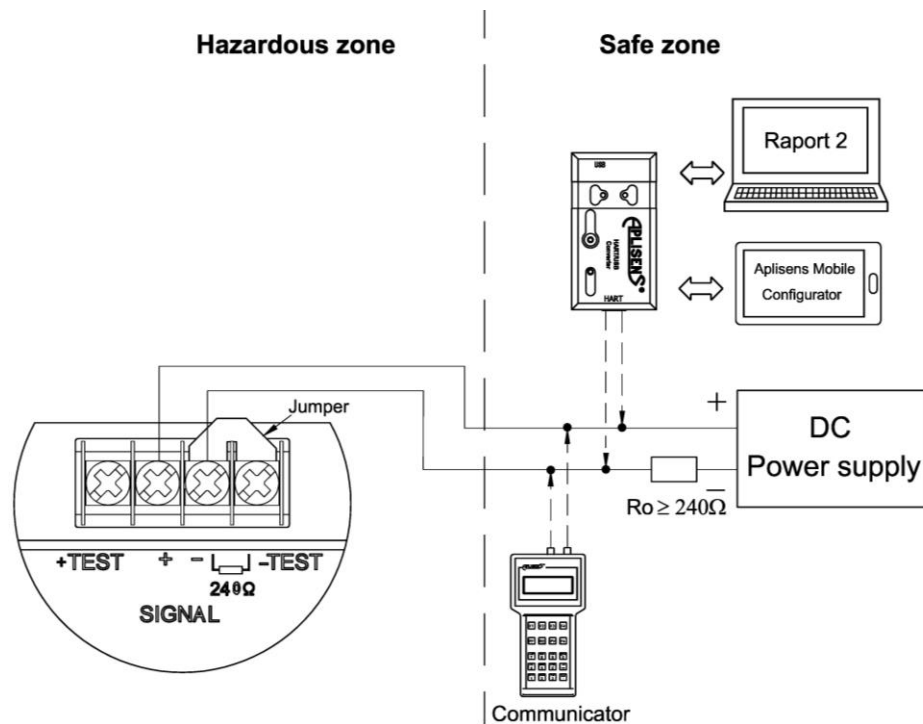

Figure 7. Electrical connection 4...20 mA of HART to transmitter in Exd version.

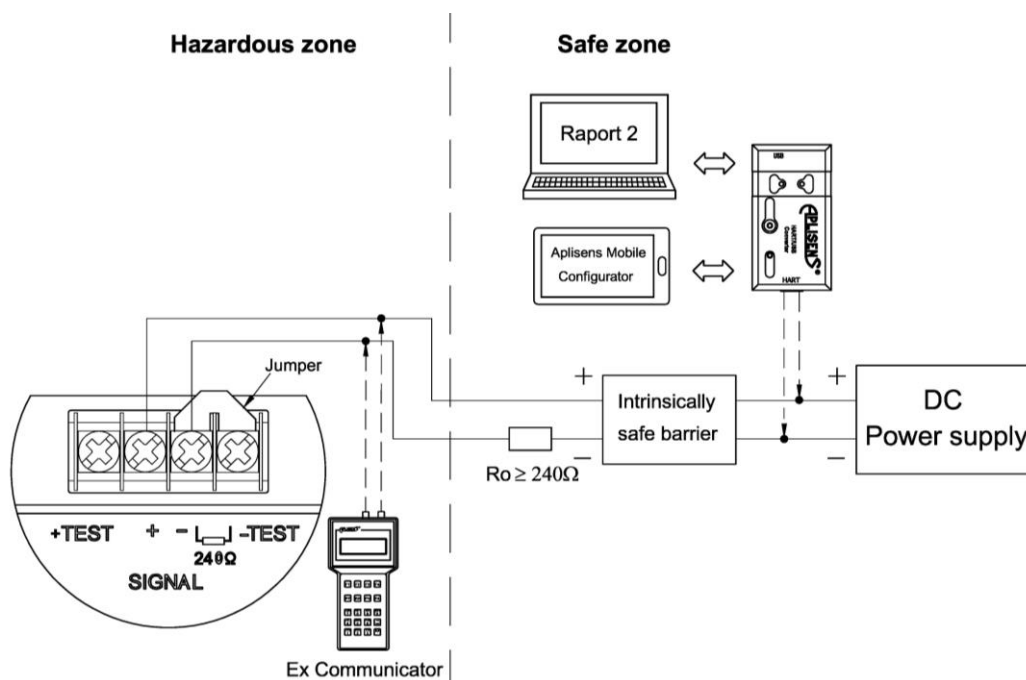

Figure 8. Electrical connection 4...20 mA of HART to transmitter in Exi version.



It is mandatory to read EN.IX.APC.APR.ALW Explosion-proof Device User Manual, containing important information related to the installation of intrinsically safe and flameproof versions of the transmitter.



It is mandatory to read EN.FM.APC.APR.ALW Hazardous Area Installation Manual, containing important information related to the installation of intrinsically safe (IS) and explosionproof versions (XP) of the transmitter.

The converter may also be operated using **Aplisens Mobile Configurator** installed on smartphones with Android system and connected using wireless communication.

The software is available on Google Play®

<https://play.google.com/store/apps/details?id=com.aplisens.mobile.amc>

7.2. Transmitter power supply

7.2.1. Transmitter supply voltage



Power cables may be live.

There is a risk of electric shock and/or explosion.



Installation of the transmitter in explosion-risk atmospheres must comply with national standards and regulations.

All explosion protection data is given in manual EN.IX.APC.APR.ALW.

Table 3. Permissible transmitter supply voltages.

Version		Minimum supply voltage	Maximum supply voltage
Exi/Exd*	IS/XP**	11,5 V DC***	30 V DC (Exi, IS) 55 V DC (Exd, XP)
Exd*	XP**	13,5 V DC****	55 V DC
Standard		10,0 V DC	55 V DC
Exi*		10,5 V DC	30 V DC
IS**		11,5 V DC	30 V DC

* For details on intrinsically safe and flameproof version see manual EN.IX.APC.APR.ALW.
 ** For details on intrinsically safe (IS) and flameproof variant (XP) see manual EN.FM.APC.APR.ALW.
 *** Minimum supply voltage with backlight off. Possibility of turning on the backlight only by manufacturer at the transmitter production stage (then $U_{min}=14,5$ V DC).
 **** Minimum supply voltage with backlight on. Possibility of turning off the backlight only by manufacturer at the transmitter production stage (then $U_{min}=10,5$ V DC).

7.2.2. Uninterruptible current measurement in 4...20 mA current loop

The transmitter is capable of continuous current measurement in the current loop using an ammeter. In order to maintain the current measurement error below 0,05%, the internal resistance of the ammeter shall be less than 10 Ω .

Ammeter connection diagram – see: (→ [Figure 5. Electrical connection to transmitter.](#))

7.2.3. Specifications of electrical switching terminals

Internal electrical switching terminals are suitable for conductors with the cross-section from 0,5 to 2,5 mm². The internal and external electrical ground terminal of the body is suitable for conductors with cross-section from od 0,5 to 5 mm².

7.2.4. Cabling specification

Aplisens S.A. recommends using two-wire screened twisted pair cable. The outer diameter of the cable shell from 5 to 9 mm is recommended.

7.2.5. Resistance load in power supply line

The power line resistance, power source resistance and other additional serial resistances increase the voltage drops between the power source and the transmitter terminals. The maximum current of IS, Exd, XP, Exi/Exd or IS/XP transmitters under normal operation conditions is defined as $I_{max} = 20,500 \text{ mA} + E$, where E is the acceptable safety error, which is $\pm 0,160$ mA. The maximum current of standard or Exi transmitters under normal operation conditions is 20,500 mA, but during high alarm the value of current I_{max} is 22,000 mA.

The maximum resistance value in the power circuit (along with the power cables resistance) is defined by the formula:

$$R_{L_MAX}[\Omega] \leq \frac{(U - U_{min})[V]}{0,02066 [A]} \quad (\text{for transmitters in IS, Exd, XP, Exi/Exd, IS/XP version})$$

$$R_{L_MAX}[\Omega] \leq \frac{(U - U_{min})[V]}{0,02200 [A]} \quad (\text{for transmitters in standard, Exi version})$$

where:

U – voltage at the supply terminals of the 4...20 mA current loop [V].

U_{min} – minimum supply voltage of transmitter → [Table 3. Permissible transmitter supply voltages.](#)

R_{L_MAX} – maximum power supply line resistance [Ω].

7.2.6. Shielding, equipotential bonding

When using a cable in the screen, connect the screen on one side at the transmitter's power supply point.

7.3. Equipotential bonding

When using an intrinsically safe transmitter with an additional overvoltage protection, having the designation "SA version" on the plate, the transmitter should be powered from a galvanically separated power source or, if this is not possible, equipotential bonding of the transmitter and the power supply device should be ensured by means of equipotential bonding conductors. In this respect the locally applicable regulations must be observed.

7.4. Overvoltage protection

Transmitters comply with EMC standards for safety-related products used in general industrial environment. Transmitters in standard and flameproof versions are fitted with overvoltage protection. In intrinsically safe transmitters, in order to increase the resistance to excessive surge, it is possible to use the overvoltage protection **SA** version. Transmitters with integrated overvoltage protection **SA** should be grounded.

Overvoltage protection parameters in transmitters in standard, Exd, XP or SA versions:

- discharge threshold voltage: 230 V DC;
- discharge threshold impulse voltage: 450 V (impulse 100 V/μs);
- discharge threshold impulse voltage: 600 V (impulse 1000 V/μs);
- discharge current for 1 surge: 20 kA, 8/20 μs;
- discharge current for 10 surges: 10 kA, 8/20 μs;
- discharge current for 300 surges: 200 A, 10/1000 μs.

7.5. Final inspection of cabling

After completing the electrical installation of the transmitter it is necessary to check the following:

- does the supply voltage measured at the transmitter terminals at maximum set current match the range of supply voltage specified on the transmitter nameplate?
- Is the transmitter connected according to the information given in section (→ [Cable connection to transmitter internal terminals](#))?
- Are all the screws tightened?
- Are the transmitter covers tightened?
- Are the cable gland and the gland plug tightened?

8. OPERATION

The transmitter gives the possibility of rotating the housing and adjusting the display position to the mounting position of the body. To rotate the housing, loosen the screw (item 1), position the transmitter housing (item 2) as required, tighten the screw (item 1). Access to the extensions (item 4) used to rotate the display is provided after opening the front cover (item 3).

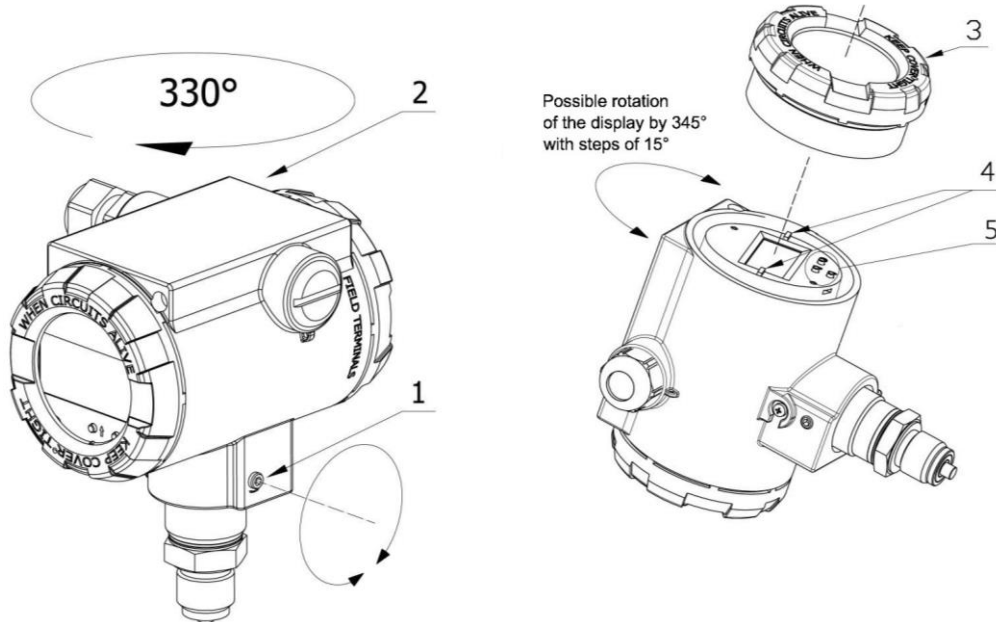

Figure 9. Rotation of the housing, change of display position and access to buttons.

1. Screw.
2. Transmitter housing.
3. Front cover.
4. Extensions for display rotation.
5. Buttons.



In hazardous zone, do not unscrew the housing covers after connecting the Exd, XP flame-proof transmitter to the power source.

The LCD has three primary information fields identified in the figure below as LCD1, LCD2, LCD3.

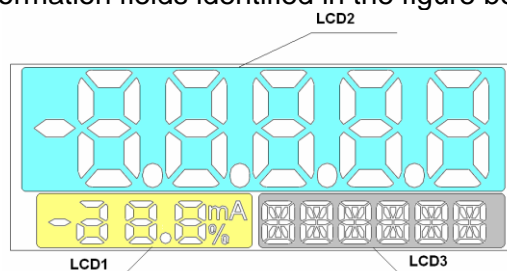

Figure 10. Display information fields.

LCD1 field:

[mA] - value (milliamperes) of process current in line 4...20 mA, proportional to the measured pressure.

[%] - value (percentage) of the setpoint $U(t)$ of current controller in current loop 4...20 mA. This value is the ratio of the process current $I_p(t)$ to the current range width according to the following formula:

$$\%U(t) = \frac{I_p(t) - 4 \text{ [mA]}}{16 \text{ [mA]}} * 100[\%]$$

LCD2 field:

The LCD2 field is used mainly to display floating point decimal values in a unit displayed on LCD3. In some cases, other messages may be displayed:

- **ERROR** in case of some operating errors or failure diagnosed in the transmitter, error/failure number **Exxxx** will appear on LCD2, the **ERROR** message will be displayed on LCD3. The image will blink to attract the operator's attention. The transmitter in Exd or Exi/Exd (also IS, XP, IS/XP) version will set the current output to alarm status I_AL<3,600 mA. The transmitter in standard or Exi version will set the current output to alarm status depending on the configuration I_AL<3,650 mA or I_AL>21,500 mA. In order to identify the cause, please refer to the chapter "**Troubleshooting**" placed in Technical Information;
- **undEr** if the limit below LRV of the set range (only in MID mode) is exceeded by the process, the LCD1 display of transmitter in Exd or Exi/Exd (also IS, XP, IS/XP) version will show the message **undEr** (under). The image will blink to attract the operator's attention. The transmitter will set the current output to alarm status I_AL<3,600 mA. For transmitters in standard or Exi version, the message will appear when 50% of the base range below the lower limit range of the set LRL (LSL) is exceeded. After reaching the LPL and when below this value up to LSAL, the transmitter freezes the refreshing of digital value of the measurement. In this situation, message "UndEr" will be displayed. The image will blink to attract the operator's attention. The diagnostic alarm mode will be enabled depending on the settings I_AL<3,650 mA or I_AL>21,500 mA. Additionally, common status PV_OUT_OF_LIMITS and status PV_LOW_LIMITED in the Sensor Block will be set, which can be read out in the diagnostic tab via HART communication. If the limit below LRV of the set range (only in MID mode) is exceeded by the process, **undEr** (under) message will appear on LCD1. The image will blink to attract the operator's attention. The transmitter will set the current output to alarm status depending on the configuration I_AL<3,650 mA or I_AL>21,500 mA;
- **ouEr** if the limit above URV of the set range (only in MID mode) is exceeded by the process, the LCD1 display of transmitter in Exd or Exi/Exd (also IS, XP, IS/XP) version will show the message **ouEr** (over). The image will blink to draw the operator's attention. For transmitters in standard or Exi version, the message will appear when 50% of the base range above the upper limit range of the set URL (USL) is exceeded. After reaching the UPL and when above this value up to USAL, the transmitter freezes the refreshing of digital value of the measurement. In this situation, the message "ovEr" will be displayed. The image will blink to attract the operator's attention. The diagnostic alarm mode will be enabled depending on the settings I_AL<3,650 mA or I_AL>21,500 mA. Additionally, common status PV_OUT_OF_LIMITS and status PV_HIGH_LIMITED in the Sensor Block will be set, which can be read out via HART communication. If the limit above URV of the set range (only in MID mode) is exceeded by the process, **ouEr** (over) message will appear on LCD1. The image will blink to draw the operator's attention. The transmitter will set the current output to alarm status depending on the configuration I_AL<3,650 mA or I_AL>21,500 mA;
- ● ● ● ● when the set position of comma (point) on LCD2 does not allow for the correct display of the process variable, four dots ● ● ● ● will appear on LCD. The image will blink to attract the operator's attention. In this situation, change the decimal point position in the local setpoint change MENU or via HART communication.

LCD3 field:**Abbreviations of physical units of pressures and levels and their description:**

INH2O	inches of water column with temperature of 0°C.	PA	pascals.
INGH	inches of mercury column with temperature of 0°C.	KPA	kilopascals.
FTH2O	feet of water column with temperature of 20°C (68°F).	TORR	torrs.
MMH2O	millimeters of water column with temperature of 20°C (68°F).	ATM	atmosphere.
MMHG	millimeters of mercury column with temperature of 0°C.	MH2O4	metres of water column with temperature of 4°C.
PSI	pounds per square inch.	MPA	megapascals.
BAR	bars.	INH2O4	inches of water column with temperature of 4°C.
MBAR	millibars.	MMH2O4	millimeters of water column with temperature of 4°C.
GSQCM	grams per square centimeter.	NOUNIT	the shortcut displayed when a unit not implemented in the transmitter is configured via HART communication.
KGSQCM	kilograms per square centimeter.		

Abbreviations of temperature measurement point name:

SENS °C	temperature of pressure/differential pressure sensor measurement structure in degrees Celsius.
CPU °C	temperature of the main CPU structure in degrees Celsius.

Abbreviations displayed during configuration via local MENU and their descriptions:

<-BACK	return to one level above in local MENU.
EXIT	going out of the local MENU.
UNIT	pressure and level unit selection menu.
SENS_T	option of measuring the temperature of pressure/differential pressure sensor measurement structure.
CPU_T	option of measuring the main CPU structure temperature.
DAMPIN	menu of selecting damping time constant of process variable.
TRANSF	menu of selecting the current output linearization function.
%SQRT	menu of selecting the deadband percentage of the root characteristics of the current output linearization.
PVZERO	pressure transmitter resetting menu and option.
SETURV	URV setting menu (upper pressure of the set range).
SETLRV	LRV setting menu (lower pressure of the set range).
BYPRES	option of setting the range according to pressure.
BYVALU	option of setting the set range by entering a value.
RESET	transmitter hot restart software menu
LCD1VR	menu for selection of the type of measurement displayed on LCD1.
LCD2VR	menu for selection of the type of measurement displayed on LCD2.
LCD2DP	menu for selecting position of comma/decimal point.
FACTOR	return to factory values menu.
RECALL	option of return to factory settings. Factory pressure/differential pressure calibrations, zero setpoints of pressure and current will be restored.
LINEAR	option of linear function of current output setpoint linearization.
SQRT	option of root function of current output setpoint linearization.
SPECIA	option of the user's special characteristics of current output setpoint linearization.
SQUARE	option of square function of current output setpoint linearization.
CURREN	option of selecting the display of set current on LCD1.
PERCEN	option of selecting the display of set percentage on LCD1.
PRESS	option of selecting the display of pressure/differential pressure on LCD2.
USER	option of selecting user's units and scaling to be displayed on LCD3.
MID_WP	MID mode setting menu. In this mode, the option of changing the setpoints related to the transmitter metrology is disabled. Additionally for Exd or Exi/Exd (also IS, XP, IS/XP) versions, exceeding of LRV and URV limits results in displaying undEr or ouEr message, blinking of the display and setting of the process output to the current alarm mode I_AL<3,600 mA. For standard or Exi transmitters, the exceeding of LRV

and URV limits results in displaying the undEr or ouEr message, blinking of the display and setting of the process output to the current alarm mode depending on the configuration I_AL<3,650 mA or I_AL>21,500 mA.

ON	MID mode activation option.
OFF	MID mode deactivation option.
X.XXXX	option of selecting position of comma/decimal point.
XX.XXX	option of selecting position of comma/decimal point.
XXX.XX	option of selecting position of comma/decimal point.
XXXX.X	option of selecting position of comma/decimal point.
XXXXX.	option of selecting position of comma/decimal point.
0 [S]	option of selecting damping time constant.
2 [S]	option of selecting damping time constant.
5 [S]	option of selecting damping time constant.
10 [S]	option of selecting damping time constant.
30 [S]	option of selecting damping time constant.
60 [S]	option of selecting damping time constant. The 60-second damping constant is only available from the local keypad; the configuration via HART in revision 5 does not allow a damping value greater than 30 seconds. Other damping values are possible to be set via HART communication.
0.0 %	option of selecting root characteristics deadband point.
0.2 %	option of selecting root characteristics deadband point.
0.4 %	option of selecting root characteristics deadband point.
0.6 %	option of selecting root characteristics deadband point.
0.8 %	option of selecting root characteristics deadband point.
1.0 %	option of selecting root characteristics deadband point.
	Other deadband values are possible to be set via HART communication.
DONE	message about the acceptance and implementation of the set-point change.

Abbreviations of local configuration errors and description of abbreviations:

ER_L07	message displayed on LCD3. It is displayed if a user tries to change the setpoint in the transmitter protected against entry (change of setpoints) or in active MID mode. message displayed on LCD3. It is displayed if:
ER_L09	<ul style="list-style-type: none"> – a user tries to change the set range by set pressure which is not within the allowable upper URL pressure. – A user tries to pressure reset when the pressure exceeds the allowable upper limit.
ER_L10	message displayed on LCD3. It is displayed if: <ul style="list-style-type: none"> – a user tries to change the set range by set pressure which is not within the allowable lower LRL pressure. – A user tries to pressure reset when the pressure exceeds the allowable lower limit.
ER_L14	message displayed on LCD3. It is displayed if: <ul style="list-style-type: none"> – the adopted URV value through the set pressure or entry of a value cannot be accepted because it causes a reduction of the set pressure range set below the allowable limit.
ER_L16	message displayed on LCD3. It is displayed if: <ul style="list-style-type: none"> – a user tried to perform an operation that is disabled or unavailable. It may be caused by: <ul style="list-style-type: none"> – attempting to access the local setpoint change MENU when the access to the local MENU is disabled; – attempting to pressure reset in the absolute pressure measurement transmitter.
WG_L14	the message will appear if the assumed LRV value through the set pressure or entry of a value causes a decrease of the current set range. Entry of LRV automatically results in the transmitter's attempt to set URV in such a way that the current width of the set range is maintained. If this is not possible due to exceeded URL, the transmitter automatically adopts the URV=URL value and a new LRV value. Since the set range width and URV deviate from previous values, a message is displayed.

ASCII characters displayed on LCD3 in user's unit:

- using HART communication, the user can configure its own 6-character unit displayed on LCD3. It is possible to display ASCII characters from the range (32...96 dec) or (20...60 hex), i.e.:

!"#\$%&'()*+,-./0123456789:;<=>?@ABCDEFGHIJKLMNPOQRSTUVWXYZ[]^_`

8.1. Local buttons

Local buttons are used to enable the configuration mode of some transmitter parameters and to navigate through MENU and accept MENU options. The MENU can be accessed by pressing and holding any of the buttons for at least 4 seconds. After this time, the LCD3 field of the local display will show an **EXIT** message. This signals entering into the MENU navigation mode.

8.2. Local configuration of setpoints

Transmitter enables local configuration of some of the most common setpoints via local buttons and local LCD display.

8.3. Navigation in local setpoints MENU

The MENU can be accessed by pressing and holding any of the buttons for at least 4 seconds. After this time, the LCD3 field of the local display will show an **EXIT** message. This signals entering into the local configuration MENU. By pressing the buttons with arrows [↑] [↓] for at least 1 second you can move up or down in MENU.

8.4. Acceptance of local setpoints

The button marked with symbol [●] is used to accept the selection. The acceptance of setpoint change is confirmed by a **DONE** message displayed on LCD3. After changing the setpoint, the transmitter leaves the local configuration change MENU. If no selection is made in the MENU mode, after 2 minutes the transmitter automatically returns to display of standard messages. The MENU can also be left by selecting and accepting the **EXIT** option.

8.5. Structure of local setpoints MENU

Press and hold any of 3 buttons for 4 seconds.

When navigating in the area of the active local MENU, holding the button required to trigger the action is minimum 1 second. Continuous pressing of the ↑ or ↓ button results in scrolling of the MENU positions every 1 second. If the local MENU remains inactive for more than 2 minutes, after this time the transmitter will automatically leave the MENU mode and will display the process variable.

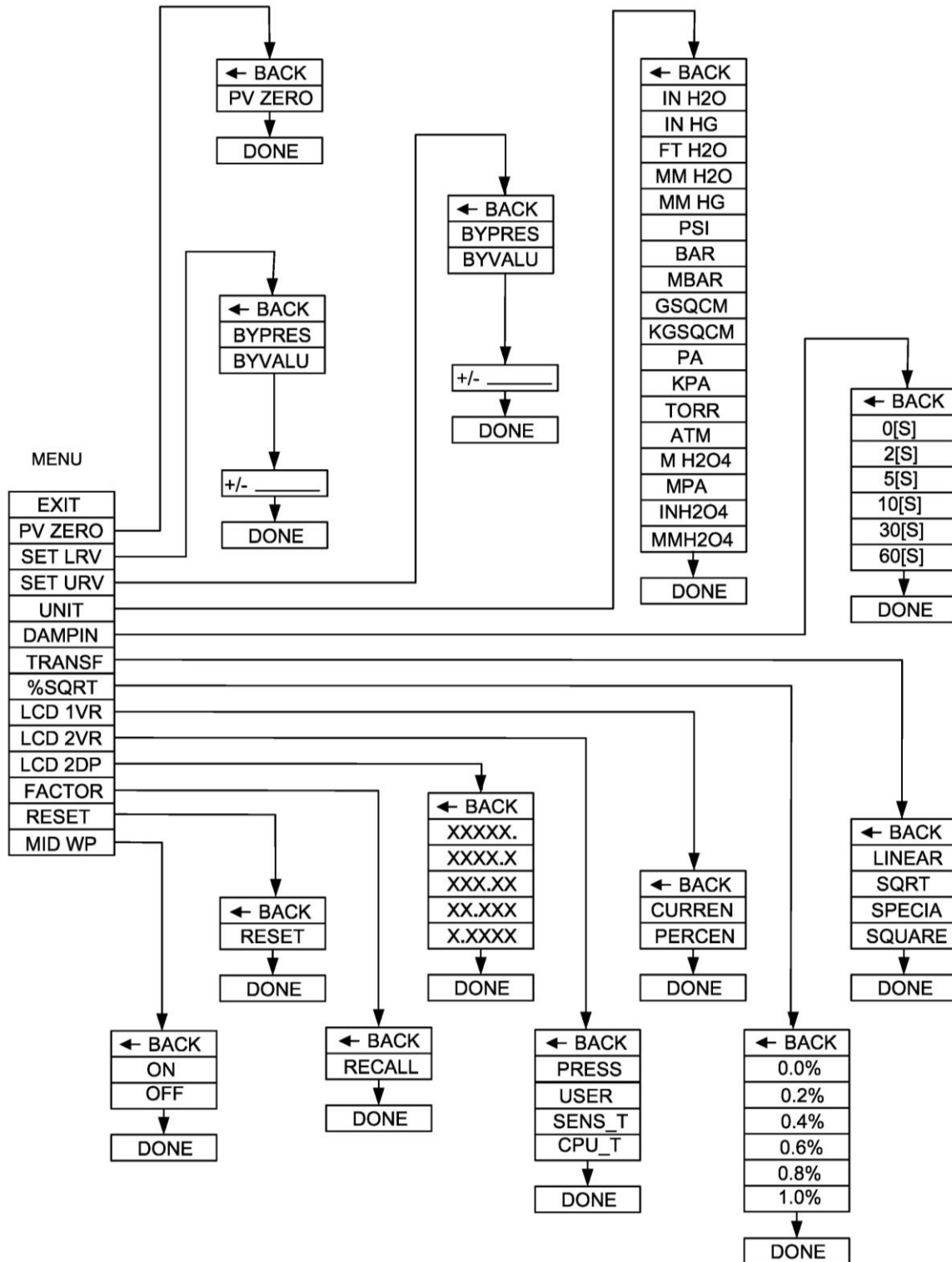

8.6. Remote configuration of setpoints (HART 5/HART 7)

The transmitter allows to read out and configure the parameters via HART communication using 4...20 mA loop as a physical layer for FSK BELL 202 modulation.

8.6.1. Compatible devices

The following devices may be used to communicate with the transmitter:

- Aplisens S.A. KAP-03, KAP-03Ex communicator (HART 5 only);
- communicators from other companies, including those using DDL and DTM libraries;
- PC computers equipped with HART modem (e.g. HART/USB converter by Aplisens S.A.) with Windows7 or Windows10 operating system with installed Raport 2;
- PC computers equipped with HART modem using software from other companies, accepting DDL and DTM libraries;
- smartphones with Android system, using a converter providing wireless communication (e.g. HART/USB converter by Aplisens S.A.) using Aplisens Mobile Configurator. The software is available on Google Play under the link:
<https://play.google.com/store/apps/details?id=com.aplisens.mobile.amc>

8.6.2. Compatible configuration software

- Raport 2 Aplisens under control of Windows 7 or Windows 10;
- Aplisens Mobile Configurator under control of the Android system;
- every software from other companies accepting DDL and DTM libraries.

8.6.3. Local HART communication jumper

The transmitter allows to use the local HART communication. To do this you can use a HART communicator unit or modem interoperating with a computer or a smartphone.

In order to establish communication, it is necessary to:

- remove the HART communication jumper (→ [Figure 6, item 2](#));
- connect the communicator or modem to terminals (→ [Connection of transmitter with the option of using local HART communication](#)).

9. START-UP

As standard, the transmitter is adjusted to a set range equal to the base range, unless a specific set range is provided in the order. The base range and the basic unit of the transmitter can be read out from its nameplate (→ [Transmitter identification](#)).



Use the transmitter within the allowable pressure limits. Risk of injury due to component breakage after exceeding the maximum permitted operating pressure.

9.1. Alarm configuration

Transmitters has a developed internal diagnostics, which monitors the work of their electronic circuits, process and environmental parameters. For transmitters in Exd or Exi/Exd (also IS, XP, IS/XP) version, diagnosed dangerous states or malfunctions of the internal transmitter systems result in setting the alarm current $I_{AL} < 3,600$ mA. For transmitters in standard or Exi version, diagnosed dangerous states or malfunctions of the internal transmitter systems result in setting the alarm current depending on the configuration $I_{AL} < 3,650$ mA or $I_{AL} > 21,500$ mA. The user has an option of enabling/disabling of the current alarms. Current alarms are disabled by default. The figures below shows the normal operation ranges of the transmitter process output and the ranges of saturation and alarm currents.

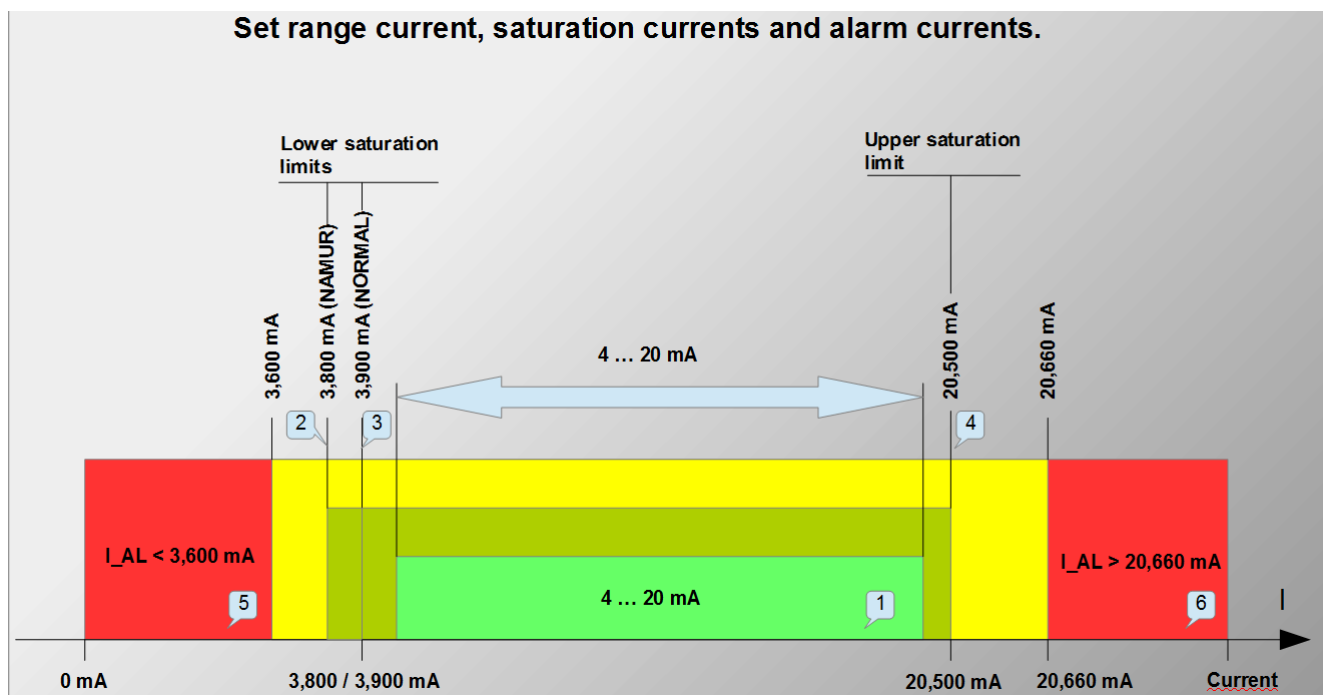

Figure 11. Set range current, saturation currents, alarm currents of transmitters in Exd or Exi/Exd (also IS, XP, IS/XP) version.

- 1 - Set 4...20 mA current area is corresponding to setpoint 0...100% of the process output.
- 2 - Lower saturation current of 3,800 mA for NAMUR mode.
- 3 - Lower saturation current of 3,900 mA for NORMAL mode.
- 4 - Upper saturation current of 20,500 mA for NAMUR and NORMAL mode.
- 5 - Alarm current area $I_{AL} < 3,600$ mA for internal diagnostic alarms.
- 6 - Alarm current area $I_{AL} > 20,660$ mA for alarms related to safe failures with external diagnostics.

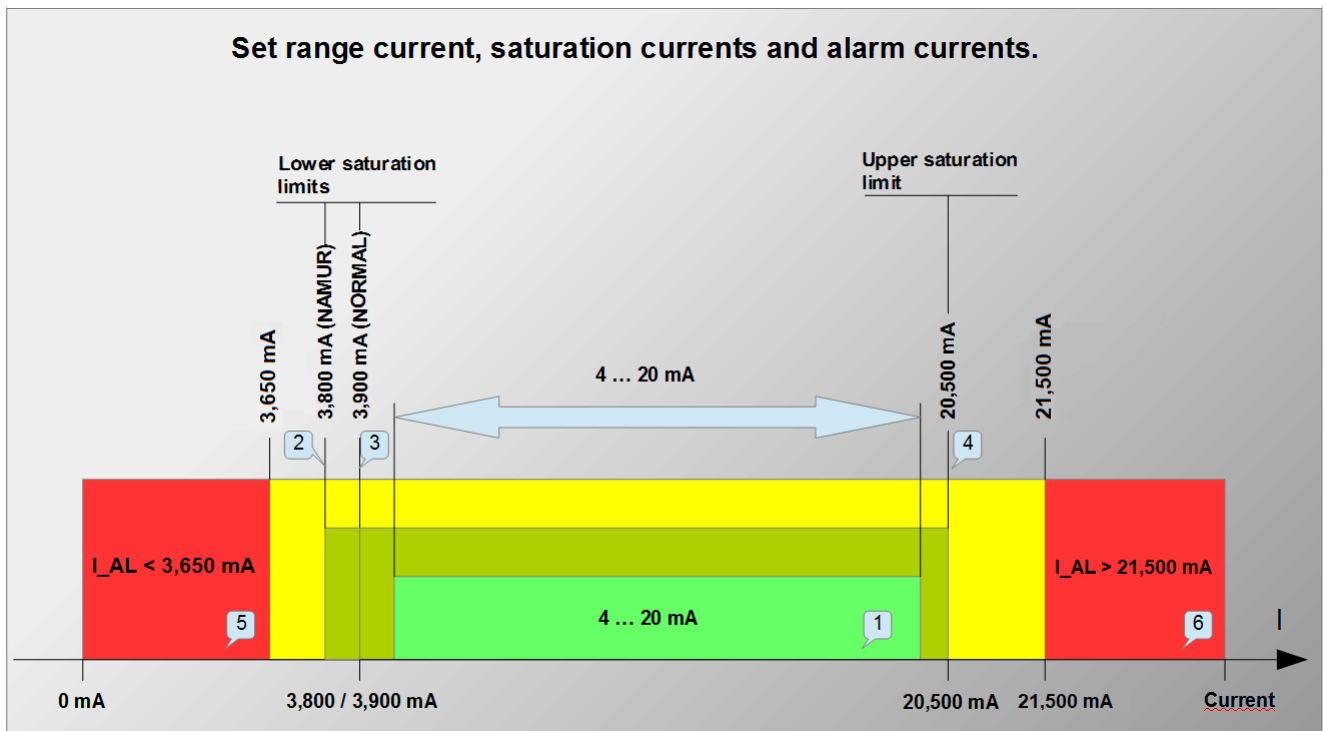

Figure 12. Set range current, saturation currents, alarm currents of transmitters in standard or Exi version.

- 1 - Set 4...20 mA current area is corresponding to setpoint 0...100% of the process output.
- 2 - Lower saturation current of 3,800 mA for NAMUR mode.
- 3 - Lower saturation current of 3,900 mA for NORMAL mode.
- 4 - Upper saturation current of 20,500 mA for NAMUR and NORMAL mode.
- 5 - Alarm current area $I_{AL} < 3,650$ mA for internal diagnostic alarms.
- 6 - Alarm current area $I_{AL} > 21,500$ mA for internal diagnostic alarms.

The transmitter diagnostics continually tests the environmental parameters:

- temperature of the pressure measurement structure sensor;
- temperature of the ADC transducer converting the electric signal from the pressure sensor to the digital value of measurement;
- temperature of the CPU structure (transmitter's main microcontroller). For transmitters in Exd or Exi/Exd (also IS, XP, IS/XP) version, if the operating temperature limits are exceeded, the diagnostics will trigger an alarm $I_{AL} < 3,600$ mA. Temperature return to permissible range of the transmitter operation will result in deactivation of the diagnostic alarm mode and return to normal operation. For transmitters in standard or Exi version, if alarms from 2, 3 and 4 process variable (temperatures) are enabled, when the transmitter operating temperature limits are exceeded, the diagnostics will trigger an alarm depending on the settings $I_{AL} < 3,650$ mA or $I_{AL} > 21,500$ mA. Temperature return to permissible range of the transmitter operation will result in deactivation of the diagnostic alarm mode and return to normal operation.

The transmitter diagnostics continually tests the pressure process parameters:

- if the pressure/differential pressure value increases above 50% of the base range width from URL point reaching the UPL point, the diagnostics of transmitter in Exd or Exi/Exd (also IS, XP, IS/XP) version will trigger an alarm $I_{AL} < 3,600$ mA. The return of the pressure/differential pressure below the UPL point will result in deactivating the alarm and returning the transmitter to its normal operation. In case of transmitters in standard or Exi version, if the pressure/differential pressure value increases to the upper limit of ADC measurement converting transducer, reaching the USAL point, the diagnostics will trigger an alarm depending on the configuration $I_{AL} < 3,650$ mA or $I_{AL} > 21,500$ mA. The return of the pressure/differential pressure below the USAL point will result in deactivating the alarm and returning the transmitter to its normal operation;

- if the pressure/differential pressure value decreases below 50% of the base range width from LRL point reaching the LPL point, the diagnostics of transmitter in Exd or Exi/Exd (also IS, XP, IS/XP) version will trigger an alarm $I_{AL} < 3,600$ mA. The return of the pressure/differential pressure above the LPL point will result in deactivating the alarm and returning the transmitter to its normal operation. In case of transmitters in standard or Exi version, if the pressure/differential pressure value decreases to the lower limit of ADC measurement converting transducer, reaching the LSAL point, the diagnostics will trigger an alarm depending on the configuration $AL_L < 3,650$ mA or $AL_H > 21,500$ mA. The return of the pressure/differential pressure above the LSAL point will result in deactivating the alarm and returning the transmitter to its normal operation.

The transmitter diagnostics continually tests electric parameters and software resources of transmitter:

- if the inner diagnostics detects the malfunctioning or failure of the transmitter which are not critical with regard of integrity of hardware and software – software of the transmitter in Exd or Exi/Exd (also IS, XP, IS/XP) version will activate alarm $I_{AL} < 3,600$ mA. The diagnostic alarm condition will continue until the failure or damage is resolved. Error/failure number **Exxxx** will appear on LCD2; the **ERROR** message will be displayed on LCD3. The image will blink to attract the operator's attention. The transmitter will set the current output to alarm status $I_{AL} < 3,600$ mA. In case of transmitter in standard or Exi version, software will activate alarm depending on the configuration $AL_L < 3,650$ mA or $AL_H > 21,500$ mA. The diagnostic alarm condition will continue until the failure or damage is resolved. Error/failure number **Exxxx** will appear on LCD2; the **ERROR** message will be displayed on LCD3. The image will blink to attract the operator's attention;
- if the internal diagnostics detects malfunctioning or failure of the transmitter which are critical from the point of view of integrity of hardware and software, such as the hardware error of RAM, FLASH, SVS, CPU logs, mathematical computation error, or if there is a difference exceeding 1% between the set process current and the current measured in the line, the transmitter will immediately stop operation and activate the critical diagnostic alarm mode. The transmitter display will be switched off. HART communication with the transmitter will not be possible. In case of transmitter in Exd or Exi/Exd (also IS, XP, IS/XP) version, in the critical diagnostic alarm mode the additional protection of the transmitter disconnects its power supply from loop 4...20 mA. In such a case, alarm current I_{AL} is much lower than 3,600 mA and is less than 0,500 mA. The transmitter will remain in OFF state until the power is disconnected and the transmitter is switched on again. In case of transmitter in standard or Exi version, in the critical diagnostic alarm mode the additional protection of the transmitter will lower the current in the loop 4...20 mA. In such a case, alarm current I_{AL} is much lower than 3,650 mA, amounting about 0,150 mA. The transmitter will remain in the critical alarm status for approx. 10 seconds, then it will attempt to restart. When the internal diagnostics detects no hardware errors after restart, the transmitter will return to normal operation.

9.2. Configuration of operating mode

Before starting the work with the transmitter, the following parameters must be configured:

- basic unit of transmitter;
- processing characteristics;
- the beginning of the set LRV range;
- the end of the set URV range;
- damping time constant;
- NORMAL/NAMUR analogue output operation mode;
- analog output operation mode in alarm status AL_L/AL_H (applies to transmitters in standard or Exi version);
- alarm mode for indicating environmental events and defects;
- transmitter tag (TAG/LONG_TAG);
- LCD display configuration parameters;
- setting of the settings change lock password.

9.3. Correction of impact of transmitter mounting position on site – pressure reset

Once the transmitter is mounted in a target location, it must be reset. This operation will eliminate the possible influence of the mounting position on the indication of pressure/differential pressure. In order to do so:

- in case of relative pressure transmitter without pressure supplied (vented), perform the pressure reset operation using the local MENU or HART communication;
- in the case of a differential pressure transmitter, at compensated pressures on the L and H supply, perform the pressure reset operation by means of local MENU or HART communication;
- in case of absolute pressure transmitter the resetting is only possible with an absolute pressure calibration device. Otherwise an attempt to reset the transmitter will display an error.

9.4. Correction of impact of spacing of distance separators on site

In pressure/differential pressure transmitters with distance separator(s), it is required to make an adjustment depending on the impact of the separator position. The adjustment is made after the transmitter has been installed on site, before filling the plant. To do this, select “SETLRV” and “BYPRES” in the transmitter menu. Upon acknowledgement (“DONE”), a 4 mA signal, including the impact of the separator positions, is set in the transmitter. The 20 mA signal is set by selecting “SETURV”. For level measurements, fill the tank to a level corresponding to 20 mA, select “BYPRES” and confirm. If it is not possible to fill the tank/plant to the value corresponding to the 20 mA signal, the URV value may be set by selecting “BYVALU” function and entering the value. The value (in pressure units) is calculated by adding the planned measurement span value to the pressure value (PV) obtained after setting the LRV signal (4 mA).

Once the transmitter parameters have been entered and it has been reset at the workstation, it is required to:

- **secure the device against the possibility of making changes in the local setpoint change MENU;**
- **set your own password different from default password of “00000000”. The new password may consist of any combination of 8 hexadecimal characters 0...9, A...F. Store the password in a safe place. If the password is lost, its restoration or resetting to factory settings may only be performed by the manufacturer;**
- **activate the setpoint change lock to secure the transmitter against accidental, unintentional change of parameters.**

Pressure reset can be done via local setpoint change MENU or HART communication. The remaining operations described in this section may only be performed using HART communication.



For Exd or Exi/Exd (also XP, IS/XP) type transmitters, opening the housing cover in the hazardous zone in order to use the local setpoint change MENU is forbidden.

9.5. Flow measurements

Differential pressure transmitter APR-2000ALW can be used for venturi flow measurements. Flow measurements often require setting of pressure-processing characteristics for output current setpoints other than linear. In APR-2000ALW transmitter the following characteristics are available for the user:

- linear characteristics;
- second-stage root characteristics with relay characteristics and 0,2% hysteresis in the deadband
- manufacturer’s dual linear characteristics No.1+ second-stage root characteristics for constant deadband = 0,6% of setpoints;
- manufacturer’s single linear characteristics No.2+second-stage root characteristics and 0,2% hysteresis in the deadband;
- square characteristics;
- special characteristics based on user-modified table.

9.6. Level measurements

Transmitters APC-2000ALW, APR-2000ALW, APR-2000ALW with diaphragm seals can be used for liquid level measurement in open or closed tanks. Examples of transmitter installation are shown in → [Figure 4. Examples of transmitter installation on tanks.](#)

The transmitter can be configured in physical units of liquid column such as water and mercury at several temperatures of the liquid. It is also possible to enter the user's unit and perform any scaling of the setpoint indication. In case of tanks with irregular shapes, it is possible to use the user's characteristics to compensate the effect of the shape on the converted volume of liquid in the tank.

9.7. Pressure and differential pressure measurements

The APC-2000ALW transmitter is intended for measuring the relative (overpressure and underpressure) and absolute gas, vapour and liquid pressure. Examples of transmitter installation are shown in → [Figure 2. Examples of pressure transmitter installation.](#)

The transmitters APR-2000ALW and APR-2000ALW with diaphragm seals measure differential pressure on orifices, impact pressure tubes, filters, level in pressure tanks, etc. Examples of transmitter installation are shown in → [Figure 3. Examples of differential pressure transmitter installation.](#)

The transmitter may be configured for one of many physical units of pressure. It is also possible to enter the user's unit and perform any scaling of the setpoint indication.

For more issues regarding pressure, vacuum, differential pressure, level, flow measurements, refer to the Technical Information.

10. MAINTENANCE

10.1. Periodic inspections

Periodic inspections shall be carried out in accordance with applicable standards. During the inspection, the condition of the pressure (absence of loosened elements and leaks) and electrical (check of connections reliability and condition of gaskets and glands) connectors, condition of separating diaphragms (tarnish, corrosion) and stability of fixing of the housing and mounting bracket (if used) shall be checked. Check the processing characteristics by performing the operations specific for the CALIBRATION and possibly CONFIGURATION procedure.

10.2. Non-periodic inspections

If the transmitter at the installation site has been exposed to mechanical damage, pressure overload, hydraulic pulses, overvoltage, deposits, medium crystallization, undercutting of the diaphragm, or incorrect operation of the transmitter is detected, the device should be inspected. Check the condition of the diaphragm, clean it, check the electrical functionality of the transmitter and the processing characteristics.



If there is no signal in the transmission line or its value is improper, check the supply line, connection status on terminal blocks, connectors, etc. Check if the supply voltage and load resistance are correct.

10.3. Cleaning/washing

To remove impurities from the external surfaces of the transmitter wipe it with a cloth dampened in water.

10.3.1. Diaphragm cleaning

The only possible method of cleaning the transmitter diaphragms is to dissolve the sludge produced.



Do not remove deposits and impurities from the transmitter diaphragms, which are formed during operation, mechanically using tools, since the diaphragms and the transmitter can be damaged.

10.4. Spare parts

Parts of the transmitter that may be worn or damaged and thus replaced: cover seal.



Other parts in the case of ATEX, PED type of transmitter may be replaced only by the manufacturer or an authorized representative.

10.5. Repair

Faulty or non-operational transmitter shall be provided to the manufacturer.

10.6. Returns

In the following cases, the transmitter should be returned directly to the manufacturer:

- need for repair;
- need for factory calibration;
- replacement of improperly selected/shipped transmitter.

11. SCRAPPING, DISPOSAL



Worn or damaged devices shall be scrapped in accordance with WEEE Directive (2012/19/EU) on waste electrical and electronic equipment or returned to the manufacturer.

12. HISTORY OF REVISIONS

Revision No.	Document revision	Description of changes
-	01.A.001/2019.07	Initial document version. Prepared by DR, DKD, KBF, DCF.
1	01.A.002/2019.09	QR codes and ID numbers have been changed. Prepared by DR, DKD, KBF, DCF.
2	01.A.003/2019.10	Change of QR codes and ID numbers due to introduction of software with HART 7 stack. Prepared by DR, DKD, KBF, DCF.
3	01.A.004/2020.03	Added information about PED execution. Prepared by DBFD.
4	02.A.005/2020.06	New document edition. Prepared by DBFD.
5	02.A.006/2020.10	Supplemented the ID numbers. Prepared by DBFD.
6	02.A.007/2021.06	Added information about FM certificate for US and Canada, editorial changes.

