

CYCLOPS L



USER GUIDE

PUBLICATION N° 809627

LANGUAGE: ENGLISH

📌 Cyclops 100L, Cyclops 160L, Cyclops 390L, Cyclops 055L



Health and Safety Information



Read all of the instructions in this booklet - including all the **WARNINGS** and **CAUTIONS** - before using this product. If there is any instruction which you do not understand. **DO NOT USE THE PRODUCT.**

Safety Signs



WARNING

Indicates a potentially hazardous situation which, if not avoided, could result in death or personal injury.



CAUTION

Indicates a potentially hazardous situation which, if not avoided, could result in minor or moderate injury to the user or users, or result in damage to the product or to property.

NOTE

Indicates a potentially hazardous situation which, if not avoided, could result in damage or the loss of data.

Signs and Symbols used on equipment and Documentation



Caution, risk of electric shock.



Caution, attention to possibility of risk of damage to the product, process or surroundings. Refer to instruction manual.



Caution, hot surface.



Protective Conductor Terminal.



Observe precautions for handling electrostatic discharge sensitive devices.

Equipment Operation

Use of this instrument in a manner not specified by Land Instruments International may be hazardous. Read **and understand** the user documentation supplied **before** installing and operating the equipment. The safety of any system incorporating this equipment is the responsibility of the assembler.

Protective Clothing, Face and Eye Protection

It is possible that this equipment is to be installed on, or near to, machinery or equipment operating at high temperatures and high pressures. Suitable protective clothing, along with face and eye protection must be worn. Refer to the health and safety guidelines for the machinery/equipment before installing this product. If in doubt, contact Land Instruments International.

Electrical Power Supply

Before working on the electrical connections, all of the electrical power lines to the equipment must be isolated. All the electrical cables and signal cables must be connected exactly as indicated in these operating instructions. If in doubt, contact Land Instruments International.

Storage

The instrument should be stored in its packaging, in a dry sheltered area.

Unpacking

Check all packages for external signs of damage. Check the contents against the packing note.

Lifting Instructions

Where items are too heavy to be lifted manually, use suitably rated lifting equipment. Refer to the Technical Specification for weights. All lifting should be done as stated in local regulations.

Contact Us

UK - Dronfield

Land Instruments International
Tel: +44 (0) 1246 417691
Email: land.enquiry@ametek.co.uk
Web: www.landinst.com

USA - Pittsburgh

AMETEK Land, Inc.
Tel: +1 412 826 4444
Email: irsales@ametek.com
combsales@ametek.com
Web: www.ametek-land.com

For further details on all LAND/Ametek offices, distributors and representatives, please visit our websites.

Return of Damaged Goods

IMPORTANT If any item has been damaged in transit, this should be reported to the carrier and to the supplier immediately. Damage caused in transit is the responsibility of the carrier not the supplier.

DO NOT RETURN a damaged instrument to the sender as the carrier will not then consider a claim. Save the packing with the damaged article for inspection by the carrier.

Return of Goods for Repair

If you need to return goods for repair please contact our Customer Service Department. They will be able to advise you on the correct returns procedure.

Any item returned to Land Instruments International should be adequately packaged to prevent damage during transit.

You must include a written report of the problem together with your own name and contact information, address, telephone number, email address etc.

Design and Manufacturing Standards



The Quality Management System of Land Instruments International is approved to BS EN ISO 9001 for the design, manufacture and on-site servicing of combustion, environmental monitoring and non-contact temperature measuring instrumentation.



Approvals apply in the USA



This instrument complies with all relevant European directives.

Operation of radio transmitters, telephones or other electrical/electronic devices in close proximity to the equipment while the enclosure doors of the instrument or its peripherals are open, may cause interference and possible failure where the radiated emissions exceed the EMC directive.

The protection provided by this product may be invalidated if alterations or additions are made to the structural, electrical, mechanical or pneumatic parts of this system. Such changes may also invalidate the standard terms of warranty.

Copyright

This manual is provided as an aid to owners of Land Instruments International's products and contains information proprietary to Land Instruments International. This manual may not, in whole or part, be copied, or reproduced without the expressed written consent of Land Instruments International Ltd.

Copyright © 2015 Land Instruments International.



CONTENTS

Contents

1	Introduction	1
1.1	General Introduction	1
1.2	About Cyclops xxxL Portable Thermometers	1
1.3	Nomenclature	1
2	Specifications	3
3	Thermometer Description	5
4	Thermometer Power Supply	7
4.1	Setting the time and date	8
5	Thermometer Controls	11
5.1	ON/OFF Switch	11
5.2	Trigger Operation	11
5.3	LCD Display Panel & Keypad	11
5.4	Adjustable Eyepiece	12
5.5	Optical Focus Ring (Not fitted to Cyclops 055L Thermometers)	12
5.6	Bluetooth/USB Connector	12
6	Optics	14
6.1	Target Size Calculation for variable focus instruments	14
6.2	Target Size Calculation for fixed focus instrument Cyclops 055L	15
6.3	Neutral Density Filter	15
6.4	Lens protection window	15
6.5	Fitting a Close-up Lens	16
6.6	Fitting a Dark Filter	16
6.7	Fitting a Dark Filter to a Close-up Lens	16
6.8	Eyepiece Optics	17
7	Display Panel Modes	19
7.1	Introduction	19
7.2	Measure Mode	19
7.3	Menu Mode	25
7.4	Menu Mode - Icon Descriptions	26
7.5	Route Mode	31

Continued...

8	Trigger Operation in 'Measure Mode'	33
8.1	Introduction	33
8.2	Classic	33
8.3	Burst	33
8.4	Latched	33
8.5	Recording	34
9	Thermometer Operation	36
9.1	Operation (Example 1: simple temperature measurement)	37
9.2	Operation (Example 2: complex temperature measurement)	38
9.3	Operation (Example 3: route mode)	39
10	Cyclops Communication	41
10.1	Bluetooth	41
10.2	USB	41
11	Emissivity	43
11.1	Emissivity values for Cyclops 100L and Cyclops 160L models	43
11.2	Practical determination of Emissivity value	45
11.3	Emissivity values for Cyclops 055L thermometers	46
11.4	Emissivity values for Cyclops 390L thermometers	46
12	Accessories and Spare Parts	48
12.1	Accessories	48
12.2	Spare Parts	50
12.3	Fitting and Using a Long Eye Relief (LER) Adaptor	51
12.4	Fitting the Industrial Rubber Casing	53
13	Maintenance	56
14	User Configuration Record	58
A1	Appendix 1 Serial Communications Data Logging Protocol	60
A2	Appendix 2 Error Codes	64
A3	Appendix 3 Data Stream Format	66



1

INTRODUCTION



Fig. 1-1 *Cyclops* portable infrared thermometer



WARNING

Never look at the sun through this instrument - this could cause severe damage to the eye.

1 Introduction

1.1 General Introduction

This publication gives you the information required to use a **Cyclops xxxL** portable thermometer.

It is important to check all equipment with which you have been supplied, and read all the literature provided with the **Cyclops** before using the thermometer for the first time. Additionally, keep all supplied literature readily available for reference when the equipment is in general use.

The equipment must only be used and maintained by suitably trained personnel, capable of following the procedures and guidelines given in this User Guide.

1.2 About Cyclops xxxL Portable Thermometers

Cyclops is a range of accurate, portable infrared thermometers.

The target temperature is measured and displayed in four simultaneous measurement types: 'Peak', 'Continuous', 'Average' and 'Valley'. The **Cyclops 055L** has an additional, special 'Meltmaster' processing output.

The wide angle (9°) field of view and the small measurement point define the target clearly and accurately. With the exception of the **Cyclops 055L** (which has a fixed focus of 5 metres), the focus of each **Cyclops** thermometer is continuously variable from one metre to infinity. Auxiliary lenses are available, which provide close focus capability.

The emissivity compensation setting can be controlled via the simple to use, icon-based menu system.

An internal memory and real time clock allow readings to be stored as they are taken, and identified when being downloaded at a later date.

The **Cyclops** has 'Bluetooth' communications and a USB port.

1.3 Nomenclature

The instrument detail label is on the right-hand side of the **Cyclops** casing. The **Instrument Type** specifies the thermometer variant and the **Serial Number** includes the manufacture date code.

Make a note of your **Instrument Type** and **Serial Number** in the spaces provided below.

Instrument Type:

Serial Number:

A second instrument label is in the battery compartment. This label displays the instrument serial number, the unique 'Bluetooth' address and the recommended battery details.

The **Bluetooth**® word mark and logos are registered trademarks owned by **Bluetooth** SIG, Inc. and any use of such marks by AMETEK Land is under license.

END OF SECTION



2

SPECIFICATIONS

2 Specifications

	Cyclops 100L	Cyclops 160L	Cyclops 390L	Cyclops 055L
Temperature range:	550 to 3000°C 1022 to 5432°F	200 to 1400°C 392 to 2552°F	450 to 1400°C 842 to 2532°F	1000 to 2000°C 1832 to 3632°F
Indication:	4/5-digit LCD in viewfinder; external backlit LCD display			
Measuring modes:	Continuous, Average, Peak, Valley			Continuous, Peak, Valley, Meltmaster
Storage:	Internal storage of up to 9999 readings, including date & time stamp. Also V2.00 Cyclops has 9 'routes' of up to 99 readings per route (V1.00 has 4 routes).			
Software:	PC and Mobile software for logging, stored data retrieval and route management (See separate User Guide)			
Optical system:	9° field of view; 1/3° measurement area (180:1 to 98% energy); eyepiece adjustable -3.75 to +2.5 diopters			
Focusing range:	1m / 39.3in to infinity;			Fixed focus, nominally 5m / 197in from thermometer body datum
135 Close-up lens:	450 to 620mm / 17.7 to 24.5in	460 to 630mm / 18.1 to 24.8in	N/A	
110 Close-up lens:	215mm / 8.5in fixed focus		N/A	
Target size:	5mm / 0.19in diameter at 100cm / 39.3in (standard) 2mm / 0.08in (135 c.u lens) 0.5mm / 0.02in (110 c.u lens)		4.8mm / 0.19in square at 101.4 cm / 39.9in from thermometer body datum	Parallel 28mm / 1.1in target spot diameter from lens to 5m / 197in
Spectral response:	1µm	1.6µm	3.9µm nominal	0.55µm nominal
Emissivity adjustment:	0.10 to 1.20 in 0.01 steps			
Response time:	30ms	30ms	<500ms to 98%	30ms
Display update:	0.5s			
Accuracy:	≤0.25%(K)	≤0.5%(K)	≤0.4% (K)	<0.5%(K)
Repeatability:	≤1°C / 2°F			
Operating temp range:	0 to 50°C / 32 to 122°F			
Power source:	One MN1604 / 6LR61 / PP3 battery or USB			
Output:	Bluetooth or USB			
Weight:	0.83kg / 1.8lb			
Sealing:	IP40			
Standard accessories:	Lens cap, Heat protection jacket, Protection window / filter, Battery, Wrist strap			
Optional accessories:	Close-up lenses, Waterproof carry case, Long eye relief eyepiece, Neutral density filters			

END OF SECTION



3

THERMOMETER DESCRIPTION

3 Thermometer Description

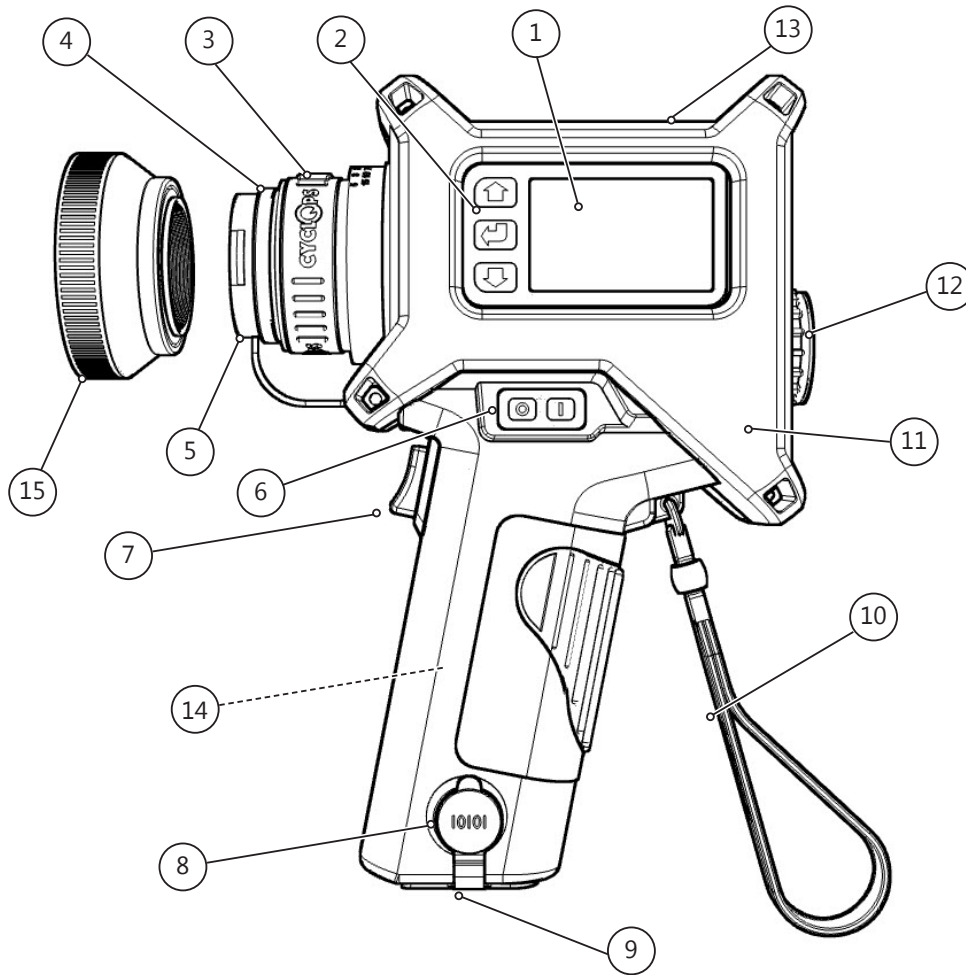

Note: Heat Protection Jacket (Part N° 811279) not illustrated

- | | | | |
|---|------------------------|----|---------------------------------------|
| 1 | LCD display panel | 9 | Tripod mounting hole |
| 2 | Keypad | 10 | Adjustable wrist strap (in packaging) |
| 3 | Optical focusing ring* | 11 | Protective cover |
| 4 | Protective window | 12 | Adjustable eyepiece |
| 5 | Lens cap | 13 | Battery compartment cover |
| 6 | ON/OFF switch | 14 | Internal Bluetooth Antenna |
| 7 | Trigger | 15 | Lens hood (in packaging) |
| 8 | USB Connector | | |

* Optical Focus Ring is not fitted to Cyclops 055L Thermometers

Fig. 3-1 **Cyclops** portable infrared thermometer

END OF SECTION

A decorative graphic in the top left corner. It features a large, bold, black number '4' on a light gray background. To the right of the '4' are several overlapping, semi-transparent gray parallelograms that create a sense of depth and movement. The top right corner of the graphic is a solid orange parallelogram.

4

THERMOMETER
POWER SUPPLY

4 Thermometer Power Supply



WARNING

This product contains a Lithium Metal Cell in compliance with Section II of P1970.

If you need to return this instrument to AMETEK Land and it is possible that it will be shipped by air, refer to the IATA Dangerous Goods Guidelines for Lithium batteries.

The **Cyclops** portable thermometer is powered by a 9V dry cell PP3 battery, or via the USB cable if it is connected to a PC. The active power source is indicated on the LCD display. When USB power is connected, no power is drawn from the PP3 battery. It is recommended to switch the thermometer off before changing the battery or inserting the USB lead. There is also a small internal cell (Lithium Metal) which maintains the clock whilst the battery is being changed. A Duracell PP3 6LR61/MN1604 (or equivalent) battery is supplied with the thermometer.

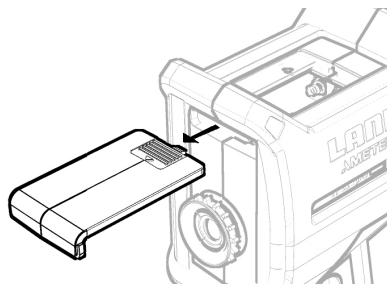

Fig. 4-1

- 1) Before inserting or changing the battery, switch the thermometer OFF.
- 2) The battery cover is on the top surface of the thermometer body (see Fig. 4-1).

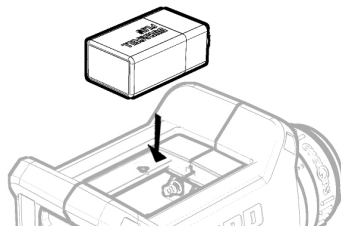

Fig. 4-2

- 3) Slide the cover back to fully expose the battery compartment (see Fig. 4-2).

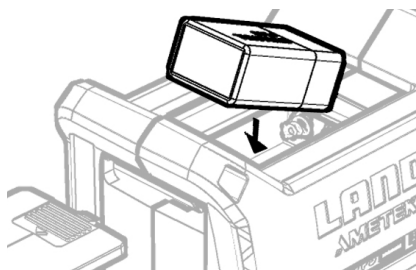

Fig. 4-3

- 4) Ensure that the battery terminals correspond with the label in the battery compartment (see Fig. 4-3).

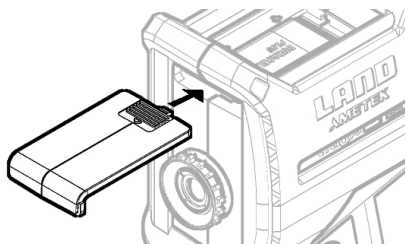

Fig. 4-4

- 5) Insert the battery, ensuring that the contact springs engage centrally into the battery terminals. Slide the battery cover back into place (see Fig. 4-4).
- 6) With the battery fitted, switch the instrument on and check for correct operation (see Section 7.0). When switched on, a battery power indicator appears in the LCD display.

When the battery needs replacing, the battery indicator on the LCD display panel will flash. To prolong battery life, switch off the display backlight and 'Bluetooth'. Change the battery as soon as possible in order to ensure that the readings from the instrument remain within specification. To preserve battery lifetime, the thermometer has the following power saving features:

- If the thermometer is in Menu Mode for over 1 minute without any key being pressed, the display returns to Measure Mode.
- If the thermometer is in Measure Mode for over 2 hours without any key being pressed, the instrument switches off.





Note

Keep a fully charged spare battery with the thermometer at all times.

4.1 Setting the time and date

When you first insert the 9V battery into the **Cyclops** thermometer, you can set the time and date. Once set, the time and date will be stored in the memory, which is powered by an additional Lithium metal cell. The time and date will be retained in memory when you subsequently change the main 9V battery.



Setting the time

- 1) Press the  button to turn on the thermometer.
- 2) Press the Enter key  to access the menu system.
- 3) Use the scroll keys ( and ) to highlight the Clock menu (scrolling up is quicker) then press Enter .
- 4) Use the scroll keys to select the Clock option, then press Enter. The clock is displayed in a 24 hour format.
- 5) Use the scroll keys to set the clock.



- Note:** if you press and hold a scroll key for approximately 5 seconds, the highlight will move to the number to the left (e.g. from 10:42 to 10:42 then to 10:42 etc.). Releasing the key will move the number back to the right.
- 6) When you have set the correct time, press Enter.

Setting the date

- 1) In the Clock menu, use the scroll keys ( and ) to highlight the Calendar option, then press Enter  .
The Calendar is displayed in DD/MM/YY format, with the **Day** setting highlighted.
- 2) Use the scroll buttons to set the required day, then press Enter.
The highlight will switch to the **Month** setting.
- 3) Use the scroll buttons to set the required month, then press Enter.
Similarly, the highlight will now switch to the year setting.
- 4) Use the scroll buttons to set the required year, then press Enter to leave the Calendar.
The date and time have now been set and will be stored in the internal memory.
- 5) Scroll to the **Exit** option and press Enter to return to the main menu

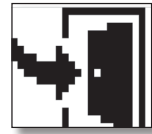

END OF SECTION

A decorative graphic in the top left corner. It features a large, bold, dark grey number '5' on a light grey background. To the right of the '5' are several overlapping, semi-transparent grey rectangular shapes that create a sense of depth and movement. A bright orange trapezoidal shape is positioned at the top right of this graphic, pointing towards the right.

5

THERMOMETER CONTROLS

5 Thermometer Controls

5.1 ON/OFF Switch

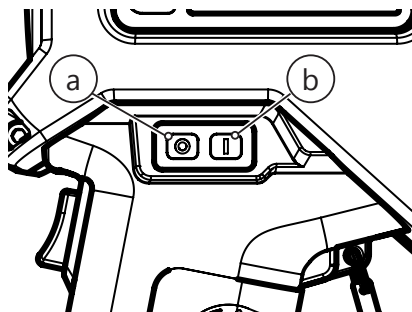

Fig. 5-1

The **On/Off** switch is on the left-hand side of the thermometer (see Fig. 3-1, item 6). The switch has two push buttons, **Off** (a) and **On** (b).

A single press of a switch will activate/de-activate the unit.

Note: if the Cyclops fails to turn on, it can be reset by pressing the **On** and **Off** Switches simultaneously. This will, however, reset the internal clock

5.2 Trigger Operation

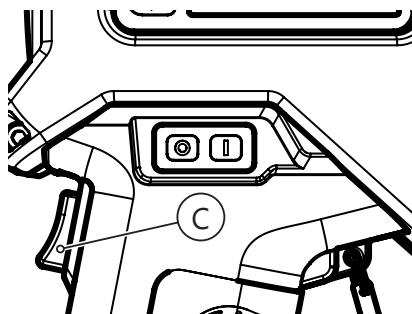

Fig. 5-2

The **Trigger** (c) is on the thermometer handle (see Fig. 3-1, item 7). The trigger function depends upon the chosen mode of operation: **Classic**, **Burst**, **Latched** or **Route** (see Section 8).

5.3 LCD Display Panel & Keypad

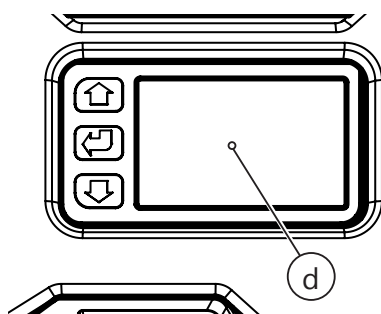





Fig. 5-3

The LCD display panel (d) is on the left-hand side of the thermometer body (see Fig. 3-1, item 1). It operates in three modes: **Measure Mode**, **Route Mode** and **Menu Mode**.

In **Measure Mode**, the scene temperature and thermometer setup information is displayed.

In **Route Mode**, scene temperature can be measured and stored against pre-loaded location IDs. See Section 7.5.

In **Menu Mode**, the function menus of the thermometer can be accessed. See Section 7.

There are three action keys on the **Keypad** to the left of the main display:  (Scroll Up),  (Scroll Down) and  (Enter/select). These are used to navigate around the various menus and displays.

5.4 Adjustable Eyepiece

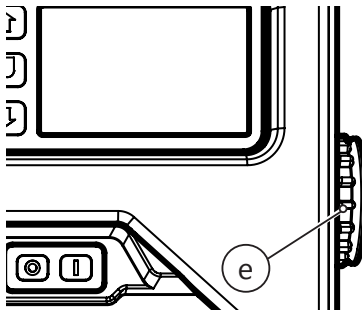

Fig. 5-4

The **Adjustable Eyepiece** (e) is on the rear face of the thermometer (see Fig. 3-1, item 12).

The eyepiece allows you to view the scene being measured by the thermometer. The eyepiece can be adjusted manually to match each user's eyesight characteristics (See section 6.3).

5.5 Optical Focus Ring (Not fitted to Cyclops 055L Thermometers)

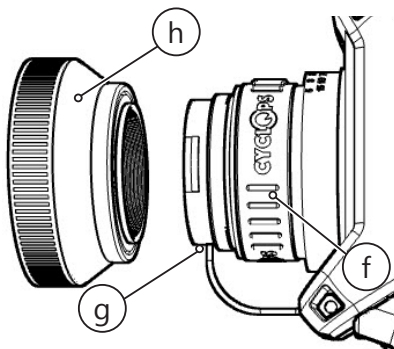

Fig. 5-5

The **Optical Focus Ring** (f) is on the lens assembly at the front of the thermometer (see Fig. 3, item 3). The focus ring allows you to manually adjust the lens assembly and sharpen the scene in view.

Note: The **Cyclops 055L** thermometer is a fixed-focus instrument and is not fitted with an Optical Focus Ring.

A protective lens cap (g) is supplied and should be fitted at all times when the thermometer is not in use.

To help protect the lens in operation, the lens hood can be fitted when the lens cap is removed.

The focal range of each model of thermometer is measured from the instrument datum (i), which is on the instrument label on the right-hand side of the thermometer.

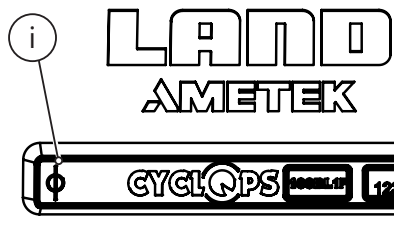

Fig. 5-6

5.6 Bluetooth/USB Connector

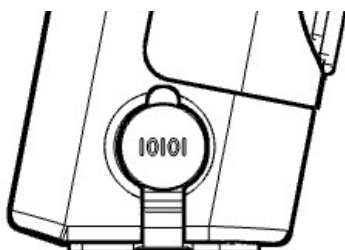

Fig. 5-7

A Bluetooth transceiver is concealed within the handle of the **Cyclops** and can be activated from the menu. See Section 10.

A mini USB connector is accessed under a rubber cover on the handle. When a USB connection is made, power for the **Cyclops** is taken from the USB +5V. See Section 10.

Note: It is recommended to switch off Bluetooth when streaming data via the USB port.

END OF SECTION



6

OPTICS

6 Optics

The **Cyclops** has a precision reflex optical system, which provides user-focusable 'Through The Lens' sighting and gives precise definition of the target spot.

For **Cyclops 100L**, **160L** and **390L**, the specified focal range is 1m/39.4in to infinity.

For **Cyclops 055L**, the focus is fixed at 5 metres (approximately 15 ft).

6.1 Target Size Calculation for variable focus instruments

This calculation applies to **100L**, **160L** and **390L** thermometers.

The precision reflex optical system gives a narrow field of view (180:1 to 98% energy). As the instrument is focusable, you can calculate an approximate target size from the information given in Fig. 6-1.

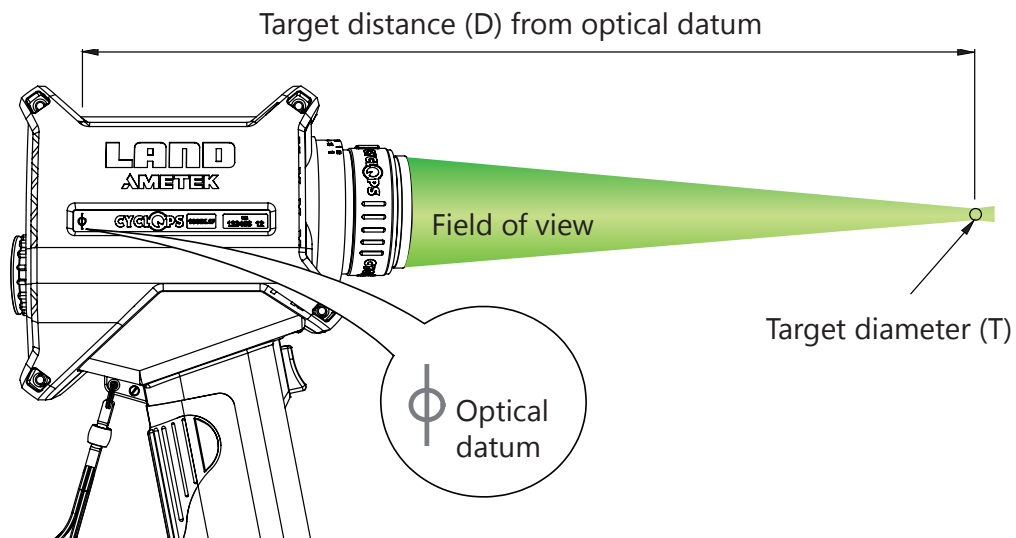

$$\text{Target size (T) (mm)} = \frac{\text{target distance (D) from optical datum (mm)} - 100}{\text{field of view (180)}}$$

or

$$\text{Target size (T) (in)} = \frac{\text{target distance (D) from optical datum (in)} - 4}{\text{field of view (180)}}$$

Fig. 6-1 **Cyclops** thermometer target size calculation

6.2 Target Size Calculation for fixed focus instrument Cyclops 055L

The **Cyclops 055L** has a precision reflex optical system, which provides 'Through The Lens' sighting and gives precise definition of the target spot. The focus is fixed at 5 metres.

Field of View

The precision reflex optical system gives a narrow field of view from the front of the instrument to 5000 mm (Fig. 6-2).

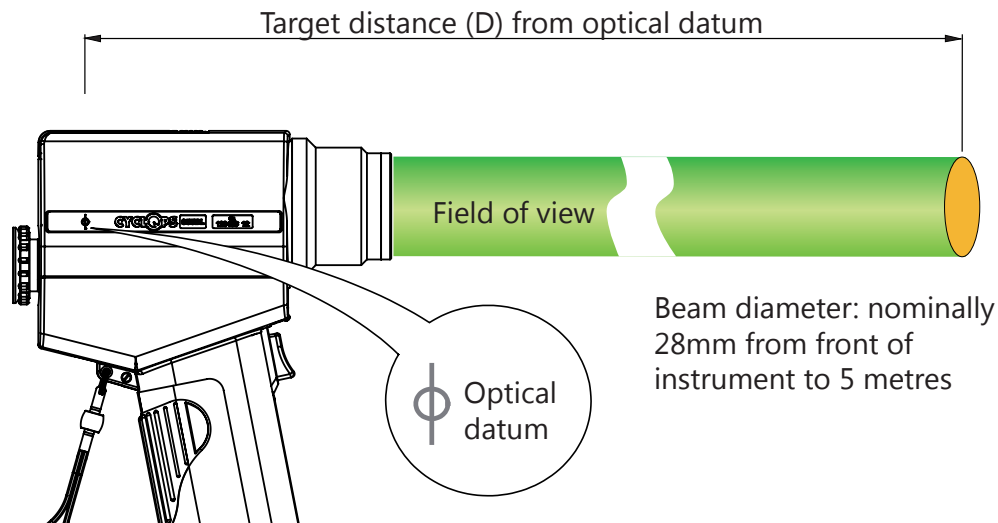

Fig. 6-2 **Cyclops 055L** thermometer field of view

6.3 Neutral Density Filter

Some **Cyclops** instruments, designated suffix **-2F**, are fitted with an additional, internal, neutral density filter within the visual sighting system. This will not affect the brightness or clarity of the internal (viewfinder) temperature display, but does provide some additional eye comfort when viewing high temperature targets.

6.4 Lens protection window

The **Cyclops** is supplied, as standard, with a protective window which covers and protects the instrument lens.

WARNING

Never look at the sun through this instrument - this could cause severe damage to the eye.

6.5 Fitting a Close-up Lens

To fit a Close-up lens to the **Cyclops** thermometer, unscrew the clear protection window from the lens assembly and replace it with the relevant Close-up lens.

The optical transmission characteristics of the protection window and the Close-up lens are similar. Therefore, there will be no significant calibration error, so window compensation is not required.

6.6 Fitting a Dark Filter

At some point, typically for targets within the range 1600°C to 2000°C / 2900 to 3600°F, the user may well find it more comfortable to also switch from the clear protection window to the dark protection window. The exact level at which this will be found necessary will depend greatly on the target's size and emissivity, and so is left to the individual user's discretion.

When measuring targets at levels above that which is found comfortable using the clear protection window (i.e. the image through the viewfinder is uncomfortably bright on the eye), a dark filter must be fitted in place of the clear protection window.

To fit a dark filter to the **Cyclops** thermometer, unscrew the clear protection window from the lens assembly and replace it with the dark filter.

The optical transmission characteristics of the protection window and the dark filter are similar. Therefore, there will be no significant calibration error, so window compensation is not required.

6.7 Fitting a Dark Filter to a Close-up Lens

When measuring targets at levels above that which is found comfortable using the Close-up lens (i.e. the image through the viewfinder is uncomfortably bright on the eye), a Close-up lens and a dark filter combination must be fitted in place of the clear protection window.

To fit a dark filter and Close-up lens combination, unscrew the protection window from the lens assembly and replace it with a Close-up lens (first), followed by a dark filter. As there will now be an extra optical element in the sight path of the instrument, a window compensation factor of 0.92 must be entered to allow for the associated energy losses. See Section 7.4.10.

6.8 Eyepiece Optics

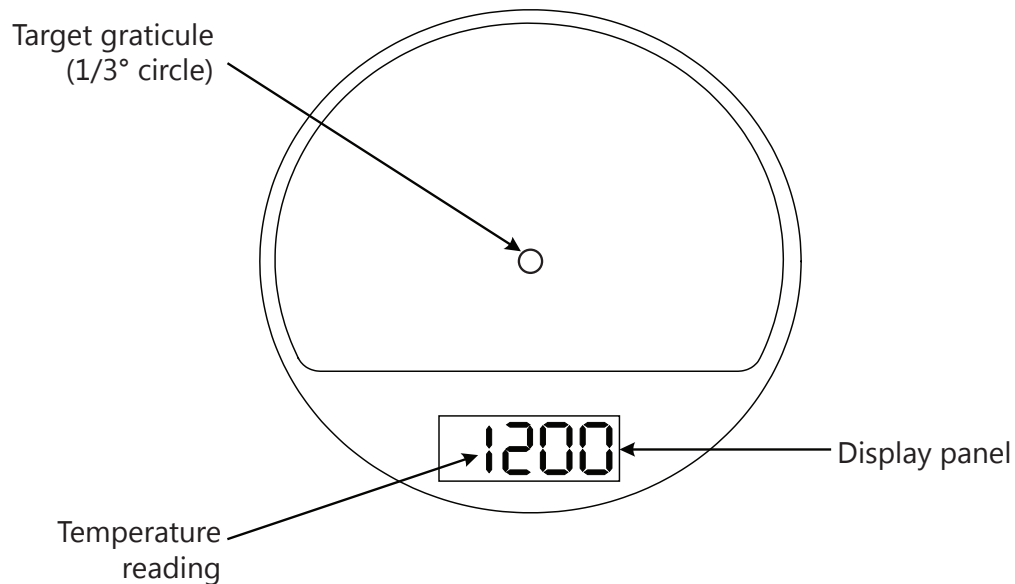

Fig. 6-3 **Cyclops** eyepiece optics

The eyepiece allows you to look into the thermometer and view the target scene. Accurate target definition is provided by the wide angle (9°) field of view and small, clearly defined ($1/3^\circ$) target graticule.

The eyepiece can be focused manually to match each user's eyesight characteristics:

- 1) Use the viewfinder to view a plain, brightly lit background, such as a blank wall.
- 2) Rotate the rubber eye cup to bring the graticule circle to the sharpest possible focus. The eyepiece is now adjusted to your eye.
- 3) Adjust the main focusing ring to bring the target scene to the sharpest possible focus on the graticule circle.

When a temperature reading is taken (the trigger pressed), the measured value is displayed in the eyepiece display panel. The temperature is displayed in the units selected from the Main Menu.

END OF SECTION

A decorative graphic in the top left corner. It features a large, bold, black number '7' on a light gray background. To the right of the '7' are several overlapping, semi-transparent gray rectangular shapes that create a sense of depth and movement. The top right corner of the graphic is a solid orange trapezoidal shape.

7

DISPLAY PANEL MODES

7 Display Panel Modes

7.1 Introduction

The LCD display panel has three basic modes of operation:

- Measure Mode
- Menu Mode
- Route Mode

When the thermometer is switched on, an introduction screen is displayed. This screen times-out automatically and is replaced by the **Measure Mode** or **Route Mode** display.

To access the **Menu Mode**, press the  (Enter/select) key on the keypad.

Note

In the event of a fault causing loss of on-board memory, an error message will be displayed near the bottom of the screen. For a list of error codes and their meanings, see Appendix 2

7.2 Measure Mode

When the unit is in Measure Mode, the display indicates the Peak, Continuous, Average, and Valley temperature values simultaneously. If you have a **Cyclops 055L**, the display shows the special Meltmaster mode temperature instead of the Average temperature.

On the side LCD display panel, the selected measurement type is displayed larger and bolder than the three non-selected measurement types. Note that the thermometer measures in all four measurement types continuously.

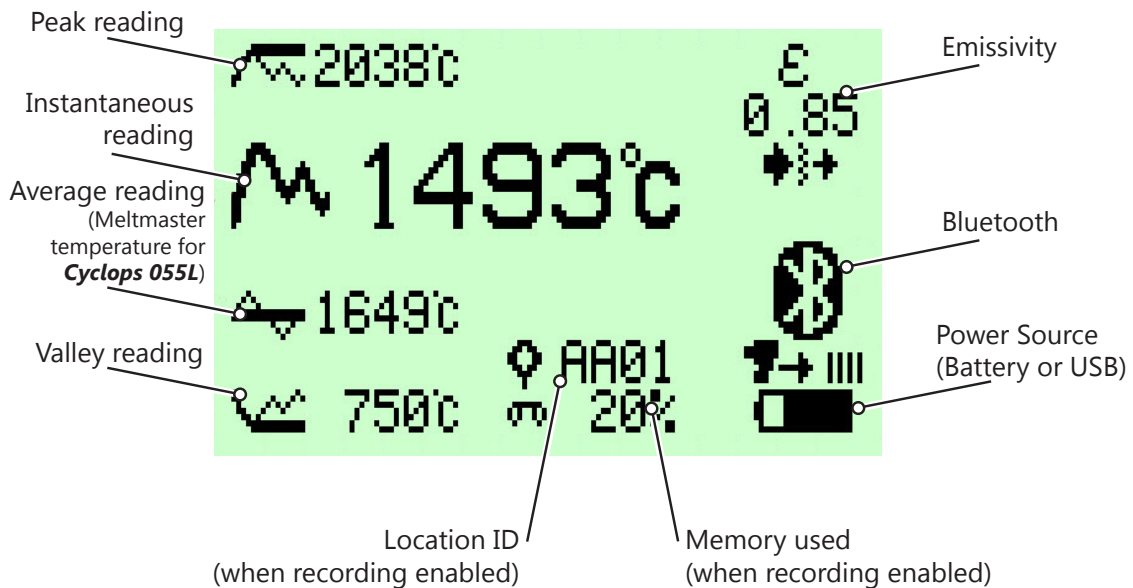



Fig. 7-1 Typical **Measure Mode** display

Scroll using the  and  keys to select and highlight the required measurement type. This measurement type is then displayed in the viewfinder.

The mode icons and associated values are cycled on the screen so that the active mode remains in the same position and larger than the non-selected measurement types.

7.2.1 Peak temperature measurement

The Peak temperature measurement mode is used to measure and display information about the highest temperatures recorded by the thermometer. The peak temperature values can be viewed in the instrument eyepiece.

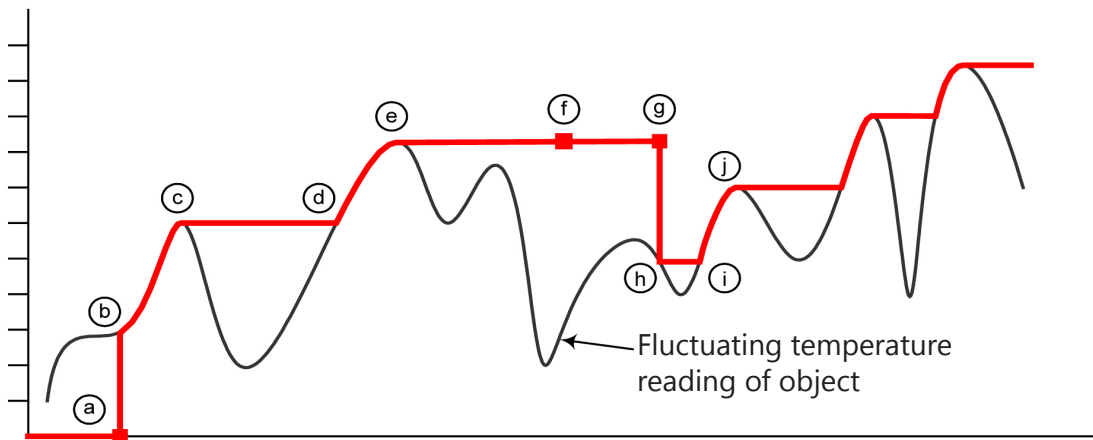

Fig. 7-2 Graphical representation of typical **Peak** temperature measurement

- a Thermometer trigger pressed
- b **Peak** temperature value on display jumps to instantaneous temperature value and rises with rise in object temperature
- c Object temperature falls, last **Peak** temperature value held on display
- d New **Peak** temperature value reached, display updated
- e Object temperature falls, last **Peak** temperature value held on display
- f Trigger released, last **Peak** temperature value frozen on display
- g Thermometer trigger pressed
- h Peak temperature value on display jumps to instantaneous temperature value (even if lower than last **Peak** value held before trigger release). Peak temperature value held on display
- i New **Peak** temperature value reached, display updated as object temperature rises
- j Object temperature falls, last **Peak** temperature value held on display



7.2.2 Instantaneous temperature measurement

Instantaneous temperature measurement provides the real-time observed temperature value. The temperature is updated continuously and the value is viewed in the instrument eyepiece.

7.2.3 Averaged temperature measurement (Not available on Cyclops 055L)

Averaged temperature measurement gives a 'smoothed' temperature value.

To use the averaging function, **press and hold down** the trigger. The averaging function operates for the period during which the trigger is held down. Averaging stops when the trigger is released.

The response time of the averaging is controlled by the **Averager Time Constant** setting in **Menu Mode**. The options are **Slow**, **Mid** and **Fast**. Use the  and  keys to select the required option from the menu.

With a **Fast** time constant selected, the temperature reading closely matches the object temperature. Only the most rapid fluctuations in the input are smoothed in the output. With a **Slow** time constant selected, the temperature reading is much smoother, displaying more of a 'trend' value rather than showing any rapid changes. With a **Mid** time constant selected, the temperature reading is calculated somewhere between the fast and slow time constant values.

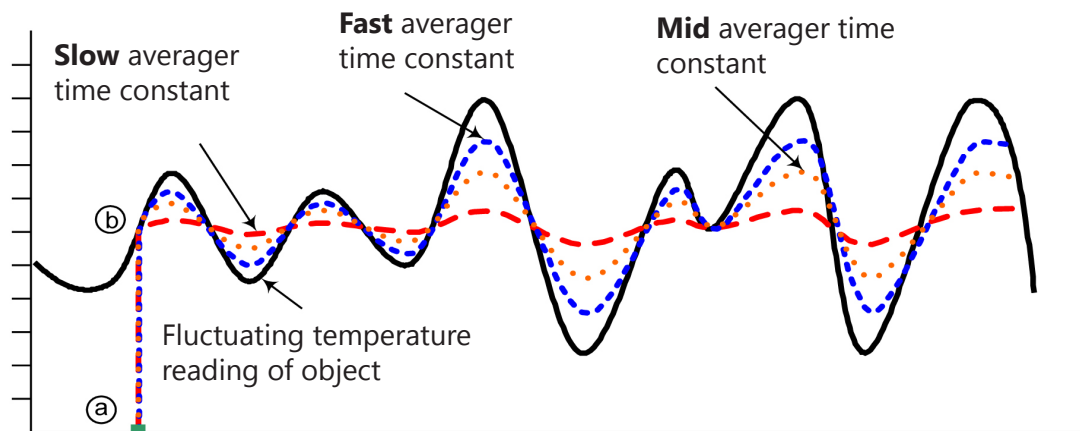

Fig. 7-3 Graphical representation of typical **Averaged** temperature measurement with Slow, Mid and Fast time constants

- a Thermometer trigger pressed
- b Averaging is initiated at the first instantaneous temperature value. Averaged temperature values are calculated, displayed and updated every half second whilst the trigger remains depressed. The final averaged value is held on the side display when the trigger is released.

7.2.4 Valley temperature measurement

Valley temperature measurement is the inverse of Peak temperature measurement, in that it allows you to monitor the lowest temperature value rather than the highest. Temperature measurement starts when the trigger is pressed in and continues until the trigger is released (See Fig. 7-4).

The temperature is updated instantaneously and the value is viewed in the instrument eyepiece.

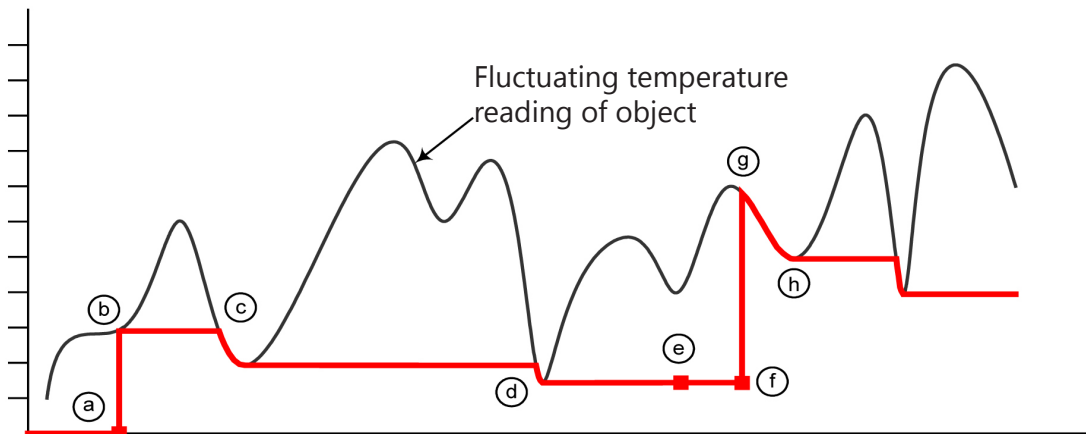

Fig. 7-4 Graphical representation of typical **valley** temperature measurement

- a Thermometer trigger pressed
- b Valley temperature value on display jumps to instantaneous temperature value and is held on display with rise in object temperature
- c Object temperature falls, new Valley temperature value reached, display updated as object temperature falls. Object temperature rises, last Valley temperature value held on display
- d Object temperature falls, new Valley temperature value reached, display updated as object temperature falls. Object temperature rises, last Valley temperature value held on display
- e Trigger released, last Valley temperature value frozen on display
- f Trigger pressed
- g Valley temperature value on display jumps to instantaneous temperature value (even if higher than last Valley value held before trigger release). Display updated as object temperature falls
- h Object temperature rises, last Valley temperature value held on display



7.2.5 Meltmaster processing function (Cyclops 055L only)

It is difficult to make a valid non-contact temperature measurement on a stream of molten metal. This is due to the large, rapid and random fluctuations that are observed in the radiation emitted from the stream.

These variations occur for a number of reasons - notably cavitation on the stream surface and emission from sparks, both of which lead to erroneously high readings, whereas obscuration by smoke will drastically reduce any measured values.

The **Meltmaster** processing function in **Cyclops 055L** is designed specifically for this measurement. It reduces the influence of these fluctuations and provides a valid estimation of the metal stream temperature.

The **Cyclops 055L** is supplied with the **Meltmaster** processing function set as the default measurement type. This means that it is the highlighted temperature type on the side display. The **Meltmaster** processing function value is displayed internally within the viewfinder, as well as being output via serial communications.

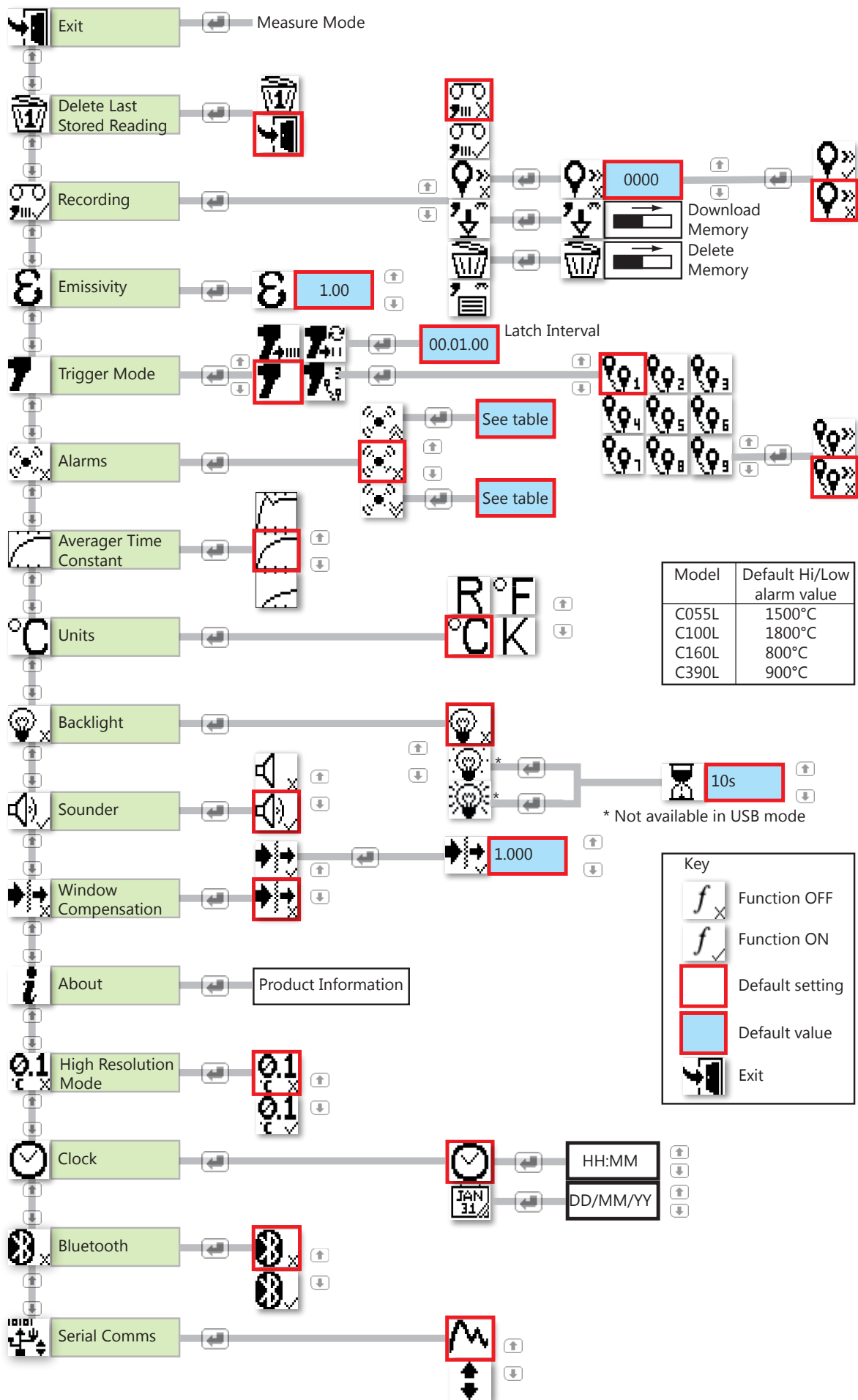













Fig. 7-5 Cyclops menu structure

7.3 Menu Mode

When the thermometer is in **Menu Mode**, the menu options available in the **Cyclops** thermometer can be accessed. This allows you to view and configure the setup of the thermometer and select the options that best suit your temperature measurement requirements.

- 1) To access **Menu Mode** press the  key.
The main menu options are displayed as icons. There are 14 main menu options, although only 8 icons are displayed within the screen at any one time (See Fig. 7-6).
- 2) Use the  and  keys to scroll through the menu options. The currently selectable menu item is highlighted by a 'flashing' frame.
- 3) To select a menu option, press the  key.
When a main menu option is selected, the available sub-options are displayed.
- 4) Use the  and  keys to highlight the required sub-option in the menu. Press the  key to select it.
- 5) For sub-options where a numeric value is required, use the scroll keys to select the required numeric value, then click on the  key to set this value. For example, to change the emissivity from 1.00 to 0.78, select the **Emissivity** menu, then press and hold in the  key to change the value from 1.00 to 0.78. If you 'overshoot' the value, use the  key to return to the required value
When changing numeric values, a key accelerator is used. The longer an arrow key is held down, the bigger the size of step change becomes. On the display panel, the digit being incremented is highlighted to indicate the size of step being made.
- 6) When you have set a required parameter value, press the  key to return to the main menu options.

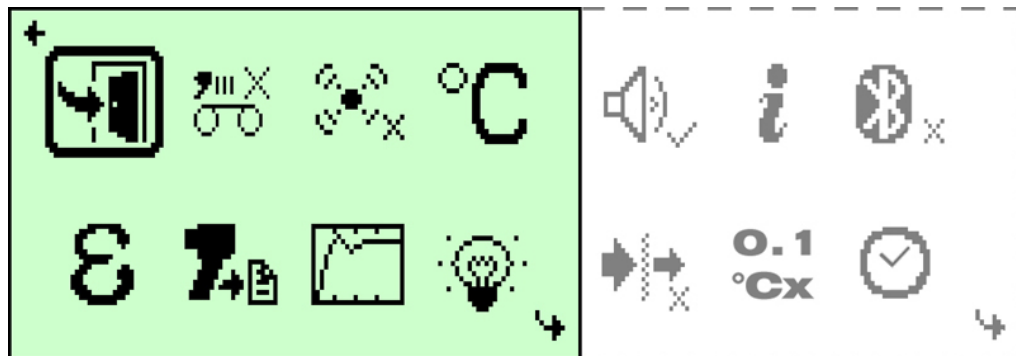

Fig. 7-6 Cyclops main menu icons **Menu Mode**

7.4 Menu Mode - Icon Descriptions



The information in this chapter should be used in conjunction with the navigational flow chart (Pages 16-17).

7.4.1 Exit

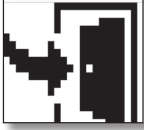
When in Menu Mode, clicking on the exit icon will return you from any sub-menu.



7.4.2 Emissivity

Use the  and  keys to enter the required value. For information on emissivity values, see Section 11 - Emissivity. The default value is 1.00.



7.4.3a Record Mode

Readings taken in Classic, Burst or Latched mode can be stored within the **Cyclops** for later download. The recording facility can be switched on or off by selecting the icons (i) **On** or (ii) **Off**.

Readings are stored against current time or date set on the clock (See Section 7.4.13).

The readings are also stored against a 4-character alpha-numeric location ID, which can be set by selecting the **ID** icon (iii). Having set the location ID, it is possible to auto-increment the ID on each trigger press, See Section 8.

The stored readings can be downloaded by selecting the **Download** icon (iv). The data is streamed to both the Bluetooth and USB outputs. The protocol of the streamed data is given in Appendix 1.

The stored readings can be deleted by selecting the **Delete** icon (v). To prevent accidental deletion, this icon requires a double entry.

The stored readings can be reviewed by selecting the **Review** icon (vi).

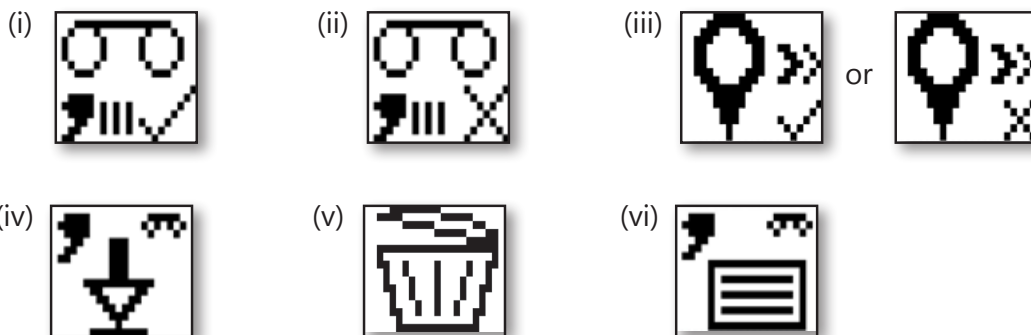

7.4.3b Deleting previous reading in Record Mode

If Record mode is enabled, the 'Delete 1' icon is available as the first menu item. This allows quick deletion of the last stored reading.







7.4.4 Trigger Mode

Trigger mode determines the way in which the thermometer operates, and what happens to the readings taken by the instrument. There are four trigger modes: **Classic** (i), **Burst** (ii), **Latched** (iii) and **Route** (iv). See Section 8 - Operational (Trigger) Modes. The default trigger mode is Classic.



7.4.5 Alarms

Allows you to specify alarm values for the target being measured. The function has three sub-options: **High Alarm** (i), **Low Alarm** (ii) and **Alarm Off** (iii). When high or low alarms are selected, a value setting screen appears. Use the  and  keys to enter the alarm trigger temperature. The default setting for High and Low alarm is the thermometer mid-range value.

When an alarm threshold value passed, a visual indication is provided on the side display ( = above high alarm value :  = below low alarm value). An audible warning (fast beep) is also provided if the sounder setting in 'On'.

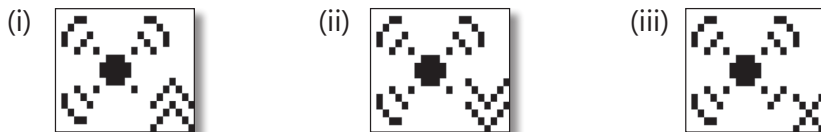

7.4.6 Averager time constant (not applicable to Cyclops 055L models)

The averager time constant function allows you to set the rate of averaging of the temperature values taken. There are three options: **Fast** (i), **Mid** (ii) and **Slow** (iii). The default setting is **Mid**.

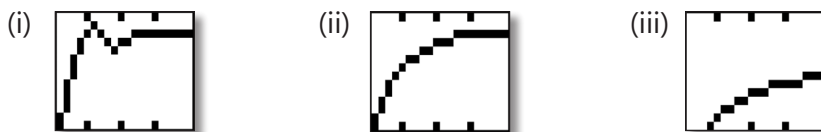

7.4.7 Units

Select °C, °F, K (Kelvin) or °R (Rankine). **Note:** If the high resolution display is selected (7.4.12), only °C is available.



7.4.8 Backlight

This setting controls the brightness of the side display backlight. There are three backlight options available: **High** (i), **Low** (ii) and **Off** (iii). When High or Low are selected, a sub-menu appears in which you can specify a time limit (in seconds) after which the backlight turns off if the thermometer is inactive. The default setting is **Off**.

Note: Use of the backlight will reduce the life of the battery. It is recommended that the backlight is switched off when not required.

Note: Backlight is not available when powered from USB.

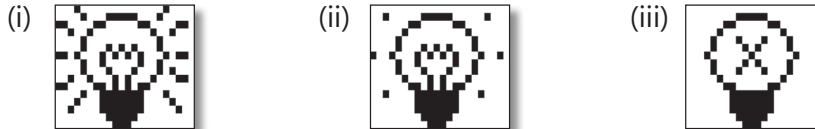

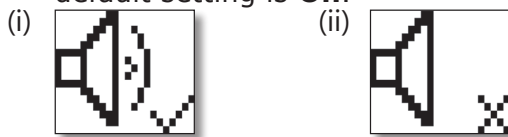

7.4.9 Sounder

This option allows you to either switch on or mute the sounder. When switched on, the sounder indicates trigger operation, alarm trip, active communications response, and lost communications response (**Bluetooth**). The available sounder options are: **Sounder On** (i), or **Sounder Off** (ii). The default setting is **On**.



7.4.10 Window compensation

This function allows you to manually incorporate a known compensation value into the temperature calculation, which allows for the reflectivity of unusual combinations of viewing windows. This function can be set to **On** (i) or **Off** (ii). If you switch the function On, a screen is displayed in which you can set the required window compensation. Use the  and  keys to adjust the value. The default setting is **1.000**. See example in Section 9.2.

Examples:

Clear protection window fitted:

Window compensation **Off**

Dark eye comfort filter fitted:

Window compensation **Off**

Close-up lens fitted:

Window compensation **Off**

Dark eye comfort filter and Close-up lens fitted:

Window compensation **On**

Value set to 0.920

An external viewing window into the customer process:

Window compensation **On**

Value to be determined practically

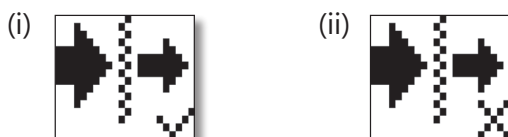

7.4.11 About

This function accesses general information about the product. The details displayed include: calibration information, thermometer serial number, **Bluetooth** identifier, software version, Tmax and Tmin ambient temperature readings since last calibration and a link to the website, www.landinst.com. Use the arrow keys to scroll up and down the screen to see the full list of information available.



7.4.12 High resolution display

When enabled, temperature is displayed at a resolution of 0.1°C.

The **High resolution display** can be set to **On** (i) or **Off** (ii). The default is **Off**.

Note: Only °C units are available with high resolution mode (See section 7.4.7).

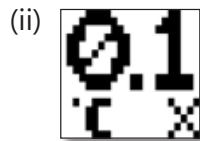

7.4.13 Clock / Calendar

Allows you to set the internal time and date (Refer to Section 4.1).

The **Clock** (i) time is in the 24 hour format HH:MM. When the time is set the seconds are reset to zero.

The **Date** (ii) is in the format dd/mm/yy.

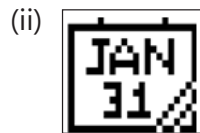

7.4.14 Bluetooth

Bluetooth communications allow wireless streaming of information from the thermometer to another device. **Bluetooth** can be set to **On** (i) or **Off** (ii). The default is **Off**.

Note that with **Bluetooth** switched **On**, the life of the battery will be reduced. It is recommended that this function is switched **Off** when not required.



7.4.15 Serial Communications

The **Instantaneous** option (i) will send the instantaneous value temperature value being measured to the serial port, regardless of what is highlighted on the side panel display. Use this option when connecting to the Land Cyclops logger software on a PC or a mobile device, or if you want to do your own processing of the temperature data.

The **Select** option (ii) will send the value highlighted in the side panel display to the serial port. Use this option when connecting to legacy software designed to work with older style **Cyclops B** thermometers, or if you want to monitor the processing done by the **Cyclops L** itself.

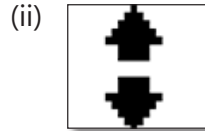
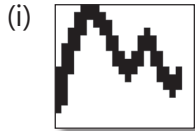

7.5 Route Mode

Route mode is accessed via the menu system (See Section 7.4.4).

Route mode allows you to load up to nine* pre-defined routes (i.e. sets of location IDs, emissivities, time functions etc.) into the **Cyclops**. Each route can contain up to 99 locations.

This mode is ideal for users who need to take a number of readings on a regular tour of their plant or process. The pre-loaded locations help to guide the user along each route.

If selected, when choosing the route number, the location will increment automatically on each trigger press.

To navigate a route manually, use the  and  keys to highlight the required location and press the thermometer trigger to take a measurement.

Note

There is **no** route data management facility in the **Cyclops** instrument itself: Routes must be set up and loaded into the **Cyclops** using the external software, which is available for download to PC and mobile devices at: www.landinst.com/software-downloads

Once all measurements on a route have been taken and stored, they can be downloaded from the **Cyclops** to the external software.

Refer to the Cyclops Logger Software User Guide for instructions on how to program a route.

* Cyclops v2.00 = 9 routes, v1.00 = 4 routes

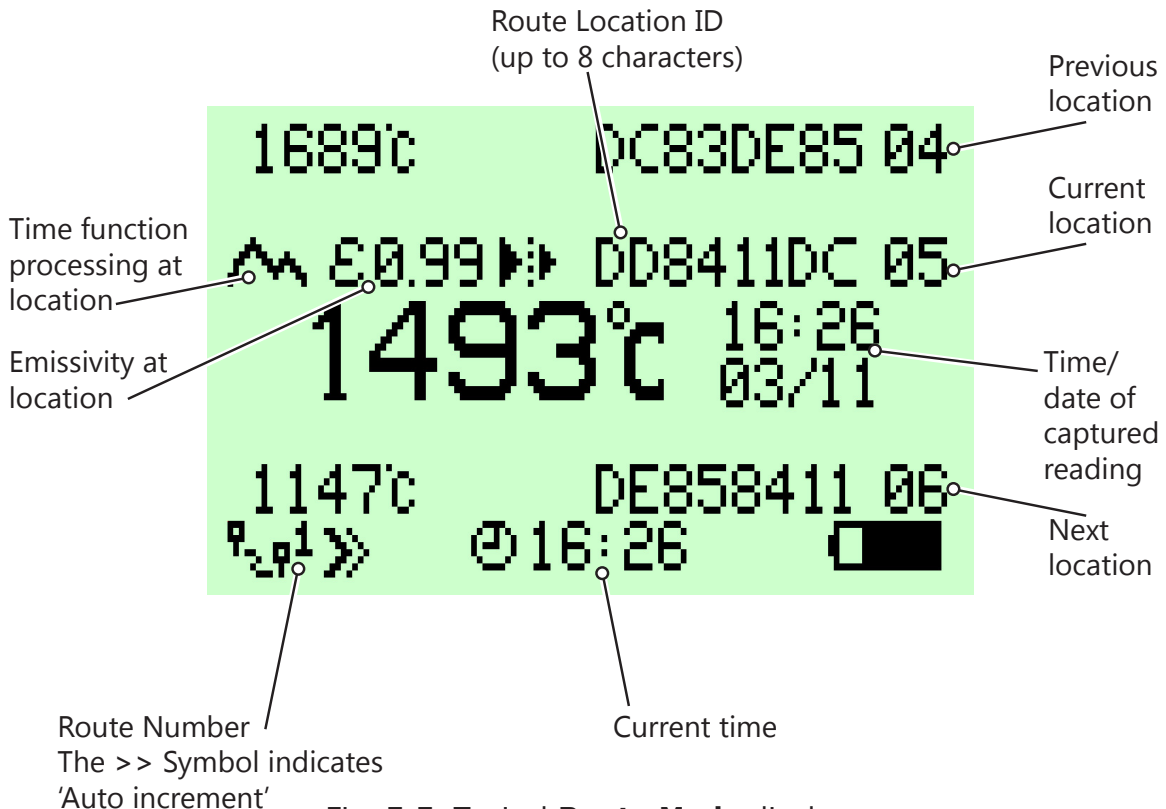

Fig. 7-7 Typical **Route Mode** display



8

TRIGGER OPERATION
IN 'MEASURE' MODE

8 Trigger Operation in 'Measure Mode'

8.1 Introduction

The **Cyclops** trigger can be set to operate in three ways:

- **Classic**
- **Burst** (not **Cyclops 055L**)
- **Latched** (not **Cyclops 055L**)

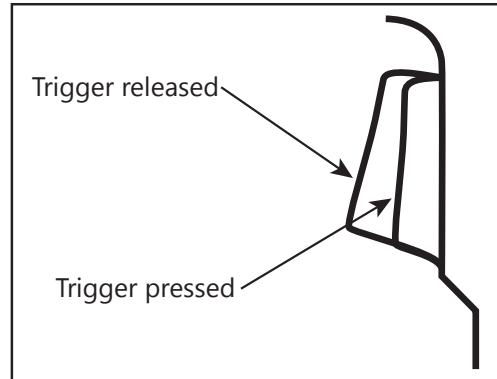

8.2 Classic

'Classic' operation is the simplest operation and the one that most closely resembles early Cyclops portable thermometers.

All four measured temperature types (**Peak**, **Instantaneous**, **Average** and **Valley**) are displayed on the side LCD panel. If you have a **Cyclops 055L**, the display shows the special **Meltmaster** mode temperature instead of the Average temperature.

The highlighted temperature type is displayed in the viewfinder. Temperature values are streamed serially, via **Bluetooth** and USB, in 0.5s intervals when the trigger is pressed (see Section 7.4.15 and Appendix A1). When the trigger is released, streaming stops and all four temperature types are stored internally (if recording is enabled).

8.3 Burst

'Burst' operation can be used for monitoring rapid changes of temperature, or recording a temperature profile, such as a long strip of material.

When the trigger is pressed, the instantaneous temperature is streamed at the maximum collection rate (approximately 33 readings per second) via **Bluetooth**, or (if enabled) recorded to internal memory. This mode of operation is denoted by the internal display 'blinking' in unison with the sounder 'beeping' (if switched on) at approximately 0.5 second intervals.

When the trigger is released, a 2-piece data packet is added to the readings, giving the emissivity and window transmission factor values.

8.4 Latched

When 'Latched' mode is selected, temperature measurement is started and stopped on alternate presses of the trigger. It is therefore ideal if you want to leave the **Cyclops** to take readings of a target at configurable interval durations. The instantaneous value is streamed over **Bluetooth**/USB or (if enabled) recorded to internal memory.

When latched mode is selected, you must enter the duration required between each reading. The range of the duration is 0.25 seconds to 120 minutes. Time function processing is restarted for each measurement. If you select a duration shorter than 0.25 seconds, the '∞:∞:∞' infinite option is enabled. This takes a single reading between trigger presses: starting the time function processing on the first press, and completing it on the second.

8.5 Recording

To enable recording for any 'measurement mode' trigger operation, enter the menu and select the recording icon. In the recording sub-menu, the recording can be enabled (See Section 7.4.3).

Recording Mode:



When enabled, the temperature values are stored for later downloading, along with the time, date, emissivity, window transmission and a user-specifiable location ID.

Up to 9999 readings can be stored. This is each reading in 'Classic' or 'Latched' mode, or approximately 5 minutes of 'Burst' mode data.

With the recording mode is active, the user-settable Location ID and the percentage of memory used are displayed on the side LCD screen.

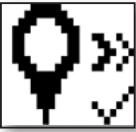
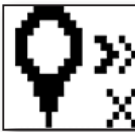
- (i)  (ii)  To change the Location ID, select the icon the in the recording menu. The Location ID has an 'auto-increment' option which can be switched On (i) or Off (ii). When switched on, each trigger press will increment the numeric digits on the right hand side of the ID by +1. e.g. if the ID is AB00, then the numeric digits on the right hand side will increment from AB00 to AB99; if the ID is A000 it will increment up to A999.



To download the stored readings over **Bluetooth** or USB, click on the download icon. The readings that have previously been recorded will be sent from the Cyclops via USB serial or Bluetooth, along with the extra data associated with each reading. See Appendix 3 for the data stream format.

In order to receive the data sent, the user will need to run software that can accept the ASCII stream from the PC communications port associated with the Bluetooth/USB connector. Alternatively, the external Cyclops Logger software can provide this functionality



To review the stored readings, select the **Review** icon.



To clear the internal memory, select the **Erase** icon.

When the memory is 100% full (displayed on the side LCD screen), recording mode will be disabled automatically and the memory will need to be erased before any further measurements can be recorded. Any operation that is currently in progress, e.g. running latched mode, will continue but no readings will be stored.

END OF SECTION



9

THERMOMETER OPERATION

9 Thermometer Operation



WARNING

Never look at the sun through this instrument - this could cause severe damage to the eye.

This section gives some sample scenarios in which the **Cyclops** may be used. Prior to temperature measurement, the thermometer must be set up as required by the chosen scenario.

The setup procedure can be split into three different setup groups:

- Data Output Setup
- Measurement Setup
- Recording Setup
- User Interface Setup

The following list details the setup groups and the available selections.

Setup Group	Function	Selection Options
Data Output Setup	Trigger Mode	Classic / Burst / Latched / Route
	Bluetooth	On / Off
Measurement Setup	Units	°C / °F / K / °R
	High Resolution	0.1°C
	Emissivity	(0.10 to 1.20)
	Averager Time Constant	Fast / Mid / Slow
	Window Compensation	On (0.80 to 1.20) / Off
Recording Setup	Enable	On / Off
	Clock	Time & Date
	Location ID	4-digit alphanumeric (auto-increment)
User Interface Setup	Backlight	High (enter timer value)
		Low (enter timer value)
		Off
	Sounder	On / Off
Alarms	High Alarm (enter set point value)	
	Low Alarm (enter set point value)	
		Off

9.1 Operation (Example 1: simple temperature measurement)

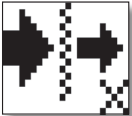
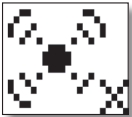
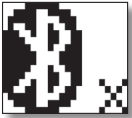
- 1) Switch the thermometer on via the On/Off switch. The initialisation screen will appear and, after a few seconds, the screen will change to show the measurement mode display.
- 2) Check the battery status, ensure that there is sufficient battery life remaining.
- 3) If the trigger mode is not already set to **Classic Mode**, go into **Menu Mode**, open the **Trigger Mode** menu and select **Classic Mode**. 
- 4) Enter the **Emissivity** value for the material under observation (refer to the information in Section 11).
- 5) Ensure that **Window Compensation** is **Off**. 
- 6) Ensure that the **Alarms** function is set to **Off**. 
- 7) Ensure the **Bluetooth** option is set to **Off**. 
- 8) On the side display, select the **Instantaneous** temperature measurement option (see Section 7.2).
- 9) Adjust the eyepiece to suit the user (See Section 6.3), then aim the thermometer at the target and, using the lens focus adjustment (See Section 5.5), focus the graticule onto the area under observation. Check that the graticule is fully filled by the target, re-position if necessary.
- 10) Press the trigger to start measurement. The main display and eyepiece display are updated with the reading
- 11) Release the trigger to stop measurement and freeze the last recorded value on the main display.

9.2 Operation (Example 2: complex temperature measurement)

In some industrial applications, a window or viewing port may be situated between the thermometer and the target object. This can lead to a reduction in the amount of radiant energy reaching the thermometer from the target.

The following instructions detail the operation of a **Cyclops** in a typical complex temperature measurement application (as in Fig. 9-1).

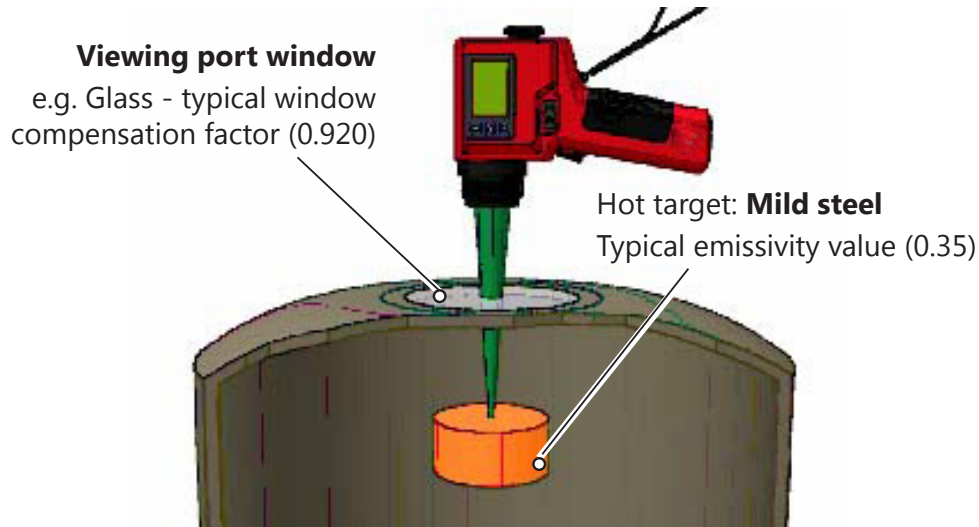



Fig. 9-1 Typical complex temperature measurement application

- 1) Check the battery status, ensure that there is sufficient battery life remaining.
- 2) Go into **Menu Mode**, open the **Trigger Mode** menu and select **Classic Mode**.
- 3) Enter the **Emissivity** value for the material under observation (0.35).
If the window compensation factor of the viewing window/port is known:
- 4) Set **Window Compensation** to **On**.
- 5) Enter the known compensation factor (e.g 0.920 for Glass, 0.880 for Sapphire)
- If the 'Window Compensation' factor of the viewing window/port is not known:*
- 6) Take and record a reading with the thermometer of a known temperature value, with the emissivity set to correspond and the **Window Compensation** factor set to default (i.e. blackbody heat source, emissivity set to 1.00 and **Window Compensation** set to 1.000).
- 7) Place a spare viewing window/port between the thermometer and the blackbody heat source and take a new temperature reading.
- 8) Enter the **Window Compensation > On** sub-menu and amend the Window Compensation factor value with the  and  keys until the display temperature reads the same as the recorded value taken from the known value source. You must now use this **Window Compensation** value, as it is correct for the chosen viewing window/port material (e.g. 0.880).

- 9) Select the **Instantaneous** temperature measurement option.
- 10) Aim the thermometer through the viewing window/port at the target and focus the graticule onto the area under observation. Check that the graticule is fully filled by the target, re-position if necessary
- 11) Press the trigger to start measurement. The main display and eyepiece display are updated with the reading.
- 12) Release the trigger to stop measurement and freeze the last recorded value on the main display.

9.3 Operation (Example 3: route mode)

- 1) Switch the thermometer on via the On/Off switch. The initialisation screen will appear and, after a few seconds, the screen will change to show the measurement mode display.
- 2) Check the battery status, ensure that there is sufficient battery life remaining.
- 3) If routes have not already been downloaded to the thermometer, connect to the **Logger Software** and follow the steps under **Route Management** in its user guide to do this.
- 4) Set the thermometer into route mode and select a route by going into **Menu Mode**, opening the **Trigger Menu** and selecting **Route Mode**, then select a route saved in memory by selecting its route number (1,2,3 or 4) and select whether you want the route location to auto-increment along the route.
- 5) When in **Measurement Mode**, the side display will now show a list of locations along the selected route, these can be navigated by using the up and down keys. Three locations and their measurements will be displayed, the middle one is the currently selected location and is where any measurements will be stored.
- 6) Press the trigger to start measurement. The currently selected location on the side display and the eyepiece display are updated.
- 7) Release the trigger to stop measurement and freeze the last recorded value on the main display.
- 8) This measurement will be stored when any of the up, down or enter keys are pressed.
- 9) The data stored on a route is saved on the Cyclops for download at a later time; this is done from the logger software using the **Download Routes** function.

END OF SECTION



10

CYCLOPS
COMMUNICATION

10 Cyclops Communication

Communication with the **Cyclops**, from the external software can be wireless (via **Bluetooth**) or via an appropriate USB cable.

If using the USB port, it is recommended that the **Bluetooth** option is switched Off in the menu.

Similarly, if **Bluetooth** communication is being used, it is recommended that the USB communications are not utilised. However, the USB can still be used for power in this instance.

To capture information from the **Cyclops**, it is best to use the Cyclops Logger software. For full operating instructions, see the Cyclops Logger software User Guide.

10.1 Bluetooth

When **Bluetooth** is enabled from the menu system, the **Bluetooth** icon on the side display will flash until paired with the Logger software.

The **Cyclops** requires a pass key of **0000**, which is provided automatically by the Logger software.

Once communication with the Logger software is established, a **IOIOI** icon appears above the **Bluetooth** icon.

The **Cyclops** and Logger software keep the **Bluetooth** communication channel alive by continually talking to each other. If the communication is stopped in any way, the **Bluetooth** icon starts to flash again and the pairing process must be repeated.

Bluetooth communications are heavy on power drain, and in order to extend battery life, they should be switched off when not required.

10.2 USB

USB communications are detected automatically by the host computer when the cable is connected.

END OF SECTION



11

EMISSIVITY

11 Emissivity

11.1 Emissivity values for Cyclops 100L and Cyclops 160L models

In order to obtain accurate temperature measurements, the emissivity value of the target surface must be known. This section of the User Guide contains typical emissivity values of the most commonly measured materials for each thermometer variant.

Where no emissivity value is quoted, this means that the thermometer may be unsuitable for the measurement application, the temperature of the target is outside the thermometer’s measurement span, or that the emissivity value cannot be accurately specified and should be determined in-situ (See Section 11.2). If you have a query regarding the emissivity of the target in your measurement application, contact AMETEK Land for assistance.

Refractories

Material	Cyclops 100L	Cyclops 160L
Alumina	0.30	0.30
Brick	<i>Red</i>	0.80
	<i>White Refractory</i>	0.30
	<i>Silica</i>	0.30
	<i>Sillimanite</i>	0.60
Ceramics	0.40	0.50
Magnesite	-	-

Alloys

Material	Cyclops 100L	Cyclops 160L
Brass	0.20	0.18
	<i>Oxidised</i>	0.70
Chromel & Alumel	0.30	0.30
	<i>Oxidised</i>	0.80
Constantin & Manganin	0.25	0.22
	<i>Oxidised</i>	0.65
Inconel	0.30	0.30
	<i>Oxidised</i>	0.85
Monel	0.25	0.22
	<i>Oxidised</i>	0.70
Nichrome	0.30	0.28
	<i>Oxidised</i>	0.85

Alloys

Material	Cyclops 100L	Cyclops 160L
Aluminium	0.13	0.09
<i>Oxidised</i>	0.40	0.40
Chromium	0.43	0.34
<i>Oxidised</i>	0.75	0.80
Cobalt	0.32	0.28
<i>Oxidised</i>	0.70	0.65
Copper	0.06	0.05
<i>Oxidised</i>	0.85	0.85
Gold	0.05	0.02
Iron & Steel	0.35	0.30
<i>Oxidised</i>	0.85	0.85
Lead	0.35	0.28
<i>Oxidised</i>	0.65	0.65
Magnesium	0.27	0.24
<i>Oxidised</i>	0.80	0.75
Molybdenum	0.33	0.25
<i>Oxidised</i>	0.80	0.75
Nickel	0.35	0.25
<i>Oxidised</i>	0.85	0.85
Palladium	0.28	0.23
Platinum	0.27	0.22
Rhodium	0.25	0.18
Silver	0.05	0.04
<i>Oxidised</i>	0.10	0.10
Tin	0.40	0.28
<i>Oxidised</i>	0.60	0.60
Titanium	0.55	0.50
<i>Oxidised</i>	0.80	0.80
Tungsten	0.39	0.30
Zinc	0.50	0.32
<i>Oxidised</i>	0.60	0.55









Miscellaneous

Material		Cyclops 100L	Cyclops 160L
Asbestos	<i>Board/paper/cloth</i>	0.90	0.90
Asphalt		0.85	0.85
Carbon	<i>Graphite</i>	0.85	0.85
	<i>Soot</i>	0.95	0.95
Cement & Concrete		0.65	0.70
Cloth - <i>All types close weave</i> <i>(Open weave reduces emissivity)</i>		0.75	0.80
Glass	<i>3mm thick</i>	-	-
	<i>6mm thick</i>	-	-
	<i>12mm thick</i>	-	-
	<i>20mm Thick</i>	0.80	-

11.2 Practical determination of Emissivity value

For many applications, such as metal alloys, it is not possible to specify a fixed emissivity value. In such instances, it is possible to make an in-situ, practical determination of the required emissivity setting by comparison with a reference measurement such as a thermocouple reading.

The procedure for doing this is as follows:

- 1) Sight the thermometer onto the target surface at the chosen measurement point. Allow the reading to stabilise and release the trigger to freeze the readings on the side display.
Note: Do not touch the trigger again until the procedure has been finished.
- 2) Using a thermocouple or reference instrument, measure the temperature at the target location.
- 3) Press the **Select** key  to go into the **Menu** mode, press the **Down** arrow key  to select the ϵ setting and press the **Select** key  to select this option.
- 4) The screen will display the current emissivity value and the last measured temperature value.
- 5) Use the **Up**  and **Down**  keys to change the emissivity value. The temperature reading will change to indicate the value that would have been obtained at the new emissivity setting.
- 6) Continue adjusting the emissivity value up or down until the displayed temperature agrees as closely as possible to the reference temperature.
- 7) Press the **Select** key  to store the new emissivity value, press the **Up**  arrow key to return to the **Exit** icon and press the **Select** key  to return to **Measure** mode.







All subsequent readings will now use the new emissivity set point.

Note that the new emissivity value will be stored at switch-off.

11.3 Emissivity values for Cyclops 055L thermometers

In order to get a true representation of the metal temperature, it is necessary to set the emissivity value. For liquid steels, this is typically in the range 0.50 to 0.55, but is known to vary slightly with alloy type and will certainly differ for other metals.

The emissivity value may be set relative to a dip thermocouple or other reference measurement by viewing the freshly cleaned surface whilst in the melting furnace. The procedure for obtaining the emissivity value is very quick and simple to perform, as described below:

- 1) From as near to the vertical as feasible, sight the **Cyclops 055L** onto the clean surface of the molten metal and press the trigger to read.
- 2) When the instrument is showing a stable temperature value, obtain a dip thermocouple, or other reference reading.
- 3) When the trigger is released, the readings are frozen on the side display. Press the 'select' key  to go into 'menu' mode, then press the  arrow key to highlight the 'ε' icon. Press the  key to select this option.
- 4) The screen will display the current emissivity value, together with the most recently recorded temperature. Changing the emissivity value will show the calculated temperature that would have been displayed at the new emissivity value.
- 5) Adjust the emissivity value up or down until the calculated temperature corresponds as closely as possible with the reference reading.
- 6) Press the  key to enter the new emissivity value, then press the  key to go to the exit icon and press  to return to 'measure' mode.

All subsequent readings will now use the newly set emissivity value.

11.4 Emissivity values for Cyclops 390L thermometers

In order to obtain accurate temperature measurements, the emissivity value of the target surface must be known.

For a **Cyclops 390L** sighting onto carbon steel slabs, the target emissivity is typically between 0.8 to 0.9, depending on the exact composition of the steel and level of oxidation.

Contact AMETEK Land for further information.

11.4.1 Emissivity values of Reformer Tubes

When measuring the temperature of reformer tubes, we strongly recommend that you use a Land Gold Cup Probe to obtain an initial accurate temperature measurement, from which you can determine the emissivity of your tubes.

A typical emissivity value is 0.85. AMETEK Land also provide a service in which we can analyse a sample of your material to determine the precise emissivity.

A decorative graphic in the top left corner. It features a light gray background with a white curved shape on the left. Overlaid on this are several diagonal stripes: a light gray stripe, a white stripe, and a bright orange stripe. The number '12' is printed in a large, bold, dark gray font over the stripes.

12

ACCESSORIES AND SPARE PARTS

12 Accessories and Spare Parts

12.1 Accessories

Type 110 & Type 135 Close-up Lenses

Type 110 (802007) and Type 135 (802008) Close-up lenses enable the Cyclops to focus on targets at distances that are too close to measure with the standard lens.

The Type 110 lens has a fixed focus at 215mm/8.5in, with a minimum target size of 0.4mm/0.016in. A typical application for this lens is hot filament/wire observation.

The Type 135 lens has a focus range of 450mm/17.7in to 620mm/24.4in, with a minimum target size of 1.8mm/0.07in. A typical application for this lens is calibration on small aperture furnaces.



Fig. 12-1 Type 110 and Type 135 Close-up lenses

Protective Hard Carrycase

The Hard Carrycase (801777) is a rugged, lightweight, waterproof and shockproof injection-moulded box, giving full environmental protection. It is supplied with custom-cut foam cushioning, with cut-outs for the thermometer and any supplied accessories, allowing all items of the 'kit' to be kept together for convenience.

Dimensions: 360 x 290 x 165mm/14.2 x 11.4 x 6.5in (width x length x depth)



Fig. 12-2 Hard Carrycase (open & closed views)

Cyclops Logger

The Cyclops Logger allows you to externally log streamed data from the **Cyclops** thermometer, whilst retaining full portability.

Each **Cyclops** is supplied with free Logger software.

AMETEK Land supply a mobile device (Part No 809633) with pre-installed Logger application and activation code. This allows you to view, analyse and record live temperature readings from the **Cyclops** on the mobile device.



Fig. 12-3 Cyclops Logger

Protective thermal cover

The protective thermal cover (811279) is strongly recommended for use in harsh environments.

The cover protects the instrument from excessive radiant heat and reduce thermal shocks. It also forms a highly effective barrier against the ingress of dust.

The large window area enables a clear view of the side display and provides access to the control keys to enable menu operation.



Fig. 12-4 Protective thermal cover

Cyclops Long Eye Relief (LER) adaptor

The Cyclops Long Eye Relief (LER) adaptor (804685) is an accessory which enables Cyclops thermometer users to be able to see the full field of view, the measurement circle and the internal temperature display, whilst the rear of the instrument is being held away from the eye. This is intended for users wearing helmets, goggles or other eye protection devices, See Section 12.3 for more information.



Fig. 12-5 LER Adaptor

Industrial rubber casing

The Industrial rubber casing (Part N° 809705) provides additional protection for your Cyclops thermometer. The casing is compatible with all models of Cyclops thermometer.



Fig. 12-6 Industrial rubber casing

Lens Hood

The Lens Hood (Part N° 809636) provides additional protection for your Cyclops thermometer lens.

Note: If you are using a Protective thermal cover, the Lens Hood will have to be removed prior to fitting the cover.



Fig. 12-7 Lens Hood

12.2 Spare Parts

Description	Part Number
Eyepiece hood	802211
Lens cover	802083
Wrist strap	801994
Battery cover	804090
Lens protection window	802061
Rubber tripod pad	802311
Protective thermal cover	811279
Industrial rubber casing	809705
Lens Hood	809636

12.3 Fitting and Using a Long Eye Relief (LER) Adaptor

The Cyclops Long Eye Relief (LER) adaptor (804685) is an accessory which enables Cyclops thermometer users to be able to see the full field of view, the measurement circle and the internal temperature display, whilst the rear of the instrument is being held away from the eye. This is intended for users wearing helmets, goggles or other eye protection devices.



Fig. 12-7 LER Adaptor

Note

Before installing the LER adaptor, examine the smaller diameter end of the unit and ensure that there is a glass disc approximately 2 mm in from this end. The plane of the glass disc is offset at a small angle ($\sim 10^\circ$) relative to the optical axis (See Fig. 12-7).

The glass disc is an infrared absorbing filter and is essential for eye safety when viewing very hot targets.

12.3.1 Instructions for Installation

- 1) Unscrew the focus adjustable eyecup anti-clockwise to extend the eyepiece length as far as possible away from the main body of the thermometer (Fig. 12-8).



Fig. 12-8

- 2) Using the screwdriver included with the kit, loosen and remove the 3 x M2, pointed end grub screws securing the eyecup holder to the eyepiece body (Fig. 12-9).
- 3) Lift the eyecup away from the rear of the eyepiece. Keep the eyepiece in a secure location, for possible future re-fitting
- 4) Insert the new LER adaptor into the end of the eyepiece and rotate until the 3 body indentations are aligned with the screw holes (Fig. 12-10).



Fig. 12-9

- 5) Replace the 3 grub screws and tighten them gently and evenly (Fig. 12-11).
Note: 3 spare grub screws are included in the LER adaptor kit.



Fig. 12-10

- 6) Screw the LER adaptor in or out to suit your requirements (Fig. 12-12).
 The Cyclops thermometer can now be used with the LER Adaptor fitted.



Fig. 12-11

12.3.2 Using a Cyclops with the LER adaptor

The thermometer should be used exactly as before, although it will be observed that there is a reduced magnification of the scene displayed through the eyepiece.



Fig. 12-12

It is possible to move the eyepiece away from the eye by at least 50mm and still see the full field of view, the measurement circle, and the internal temperature display.

The rubber cup on the LER adaptor can be used to adjust the eyepiece to obtain the best possible focus on the graticule circle, although this is usually less critical than for the standard, high magnification, eyepiece.

12.4 Fitting the Industrial Rubber Casing

①



②



③



④





END OF SECTION



13

MAINTENANCE

13 Maintenance

The **Cyclops** thermometer has been designed specifically to require very little maintenance. There are several processes that are recommended to help ensure that the instrument remains serviceable.

- Ensure that the lens cover is fitted when the thermometer is not in use.
- Ensure that the lens assembly, eyepiece and display panel are kept clean and free from contaminants. On a regular basis, clean these components carefully with a soft lens cloth and proprietary lens cleaner.
- Check the thermometer for damage regularly. Pay particular attention to the lens assembly, eyepiece, display panel, trigger and on/off switch.
- Ensure that a spare, fully charged battery is kept with the thermometer at all times.

In the unlikely event of an instrument fault, do not attempt to investigate or repair the fault on-site. Contact AMETEK Land to arrange a repair.

END OF SECTION



14

USER CONFIGURATION RECORD

14 User Configuration Record

The **Cyclops** can be configured to suit your measurement requirements. Your chosen parameter settings and values are stored in the thermometer's memory.

If the thermometer is returned to AMETEK Land for repair or recalibration, it is possible that your stored user settings may be overwritten and the thermometer returned to you with the factory default settings.

Therefore, it is recommended that once you have set up the thermometer to match your measurement requirements, you use the User Configuration Record to make a note of your chosen parameter settings and values, so that these can be re-entered into the thermometer and used again.

Serial N^o

Date:

Measurement Mode: Peak Instantaneous
 Averaged Valley

Menu Mode: Emissivity (value)

Data Output Mode: Classic Burst Latched

Alarm Settings: Alarm off
 High alarm (value)

Low alarm (value)

Averager setting: Slow Mid Fast

Temperature units: °C

Backlight Setting: Off
 Dim (timer)

Bright (timer)

Sounder Setting: Off On

Window transmission: Off
 On (value)

Bluetooth: Off On

END OF SECTION



A1

APPENDIX 1

A1 Appendix 1

Serial Communications Data Logging Protocol

The logging protocol given below applies to data streamed serially via **Bluetooth**.

Classic Mode stream

While trigger is pressed, a continuous stream of lines of data, fixed (12 for 1 deg resolution, 13 for 0.1 deg resolution) character length, every 0.5s, is output.

For firmware* V1.00 & V1.10:- Instantaneous only is available

For firmware* V2.00 and above:

- If serial option** **Instantaneous** is chosen - Instantaneous only is available
- If serial option** **Select** is chosen – the value sent in (iv) is that highlighted on the side display

* Firmware version can be found in the  menu

** Serial option can be found in the  menu

1 deg resolution

0	1	2	3	4>9	10	11
`B`	`C`	`F`	`A`	`+ 1972`	`CR`	`LF`

0.1 deg resolution

0	1	2	3	4>10	11	12
`Q`	`H`	`C`	`I`	`+1972.0`	`CR`	`LF`

(i) (ii) (iii) (iv) (v) (vi)

(i) Cyclops Identifier 1 char

`B` = C100

`D` = C055

`J` = C390

`Q` = C160

(ii) Packet Identifier 1 char

`C` Classic – while key pressed

`H` Hold – when key released

(iii) Units 1 char

`C` °Celsius

`F` °Fahrenheit

`R` Rankine

`K` Kelvin

- (iv) Mode 1 char
 - `I` Instantaneous
 - `P` Peak
 - `V` Valley
 - `A` Average
 - `S` Statistical Processing Function

(v) Data 1deg resolution Cyclops 6 chars
 : tenths to 999.0, degrees above 1000 `+100.0` `+1500`

0.1 deg resolution Cyclops 7 chars
 : in tenths `+ 100.3` `+1500.8`

Over-range : +/- --- i.e. 0xAF,SP, 0xAF,SP, 0xAF
 Under-range : +/- _ _ _ i.e. 0x5F,SP, 0x5F,SP, 0x5F

(vi) Termination 2 chars 0x0D,0x0A

The receiving device should send a `*` handshake to indicate `H` hold – i.e. key released and data logged

Advanced – Burst Mode packets

When trigger is pressed in burst mode, a continuous stream of lines of data, every 30ms is output

1deg resolution example

`B` `3` `C` `I` `+972.0` `CR` `LF`

0.1deg resolution example

`B` `3` `C` `I` `+1972.3` `CR` `LF`

Character interpretation as above except

(i) Packet `3` - advanced – burst mode packet

When trigger is released in burst mode, a 2 line termination packet is output

1 deg resolution example

{ `B` `3` `C` `E` `+1.000` `CR` `LF`

{ `B` `3` `C` `T` `+1.000` `CR` `LF`

or if disabled { `B` `3` `C` `T` `+ OFF` `CR` `LF`

0.1 deg resolution example

{ `B` `3` `C` `E` `+ 1.000` `CR` `LF`

{ `B` `3` `C` `T` `+ 1.000` `CR` `LF`

or if disabled { `B` `3` `C` `T` `+ OFF` `CR` `LF`

The receiving device should send a `*` handshake to indicate termination packet reception.

Advanced – Latched Interval Mode packet

When the trigger is latched, the data stream is exactly as in 'burst mode' above except that

- a) the data rate is user settable
- b) Character interpretation as above except
 - (i) Packet '4' - advanced – latched mode packet
- c) The 2 line termination packet is sent when the trigger is unlatched

Advanced – Route Mode packet

When the trigger is pressed, the data stream is exactly as in 'classic mode' above except that

- a) Character interpretation as above except
 - (i) Packet '5' - advanced – route mode packet
- b) the 'HOLD' termination packet is NOT sent

Bluetooth Heartbeat

To keep the Bluetooth link alive, and to establish the logger program is running, the following dummy data can be sent

1 deg resolution example

```
'B' '0' 'C' 'x' 'xxxxxxx' 'CR' 'LF'
```

0.1deg resolution example

```
'B' '0' 'C' 'x' 'xxxxxxxx' 'CR' 'LF'
```

The receiving device should send a '*' handshake to indicate heartbeat reception.

END OF SECTION



A2

APPENDIX 2

A2 Appendix 2

Error Codes

At switch-on, the **Cyclops** instrument will check all stored data in its non-volatile memory and any detected errors will be shown near the bottom of the side display screen.

Error Code 1

Description: Unknown Cyclops Type

If this code is displayed the instrument will be unable to perform any further any function.

If the error persists, return the **Cyclops** to AMETEK Land for repair.

Error Code 2

Description: Lost Calibration Data

The **Cyclops** will continue to work, but with the display inverted (i.e. white on black). However, the calibration of the instrument will be incorrect and readings will only be approximate. It will not meet the temperature accuracy specifications. If this error persists, return the **Cyclops** to AMETEK Land for repair.

Error Code 3

Description: Lost User Setting

The **Cyclops** normally stores user settings (accessed via the menu) in non-volatile memory. If these are inconsistent, the user settings will revert to factory defaults. The operator can re-enter the desired user settings to allow the **Cyclops** to work as intended.

END OF SECTION



A3

APPENDIX 3

A3 Appendix 3

Data Stream Format

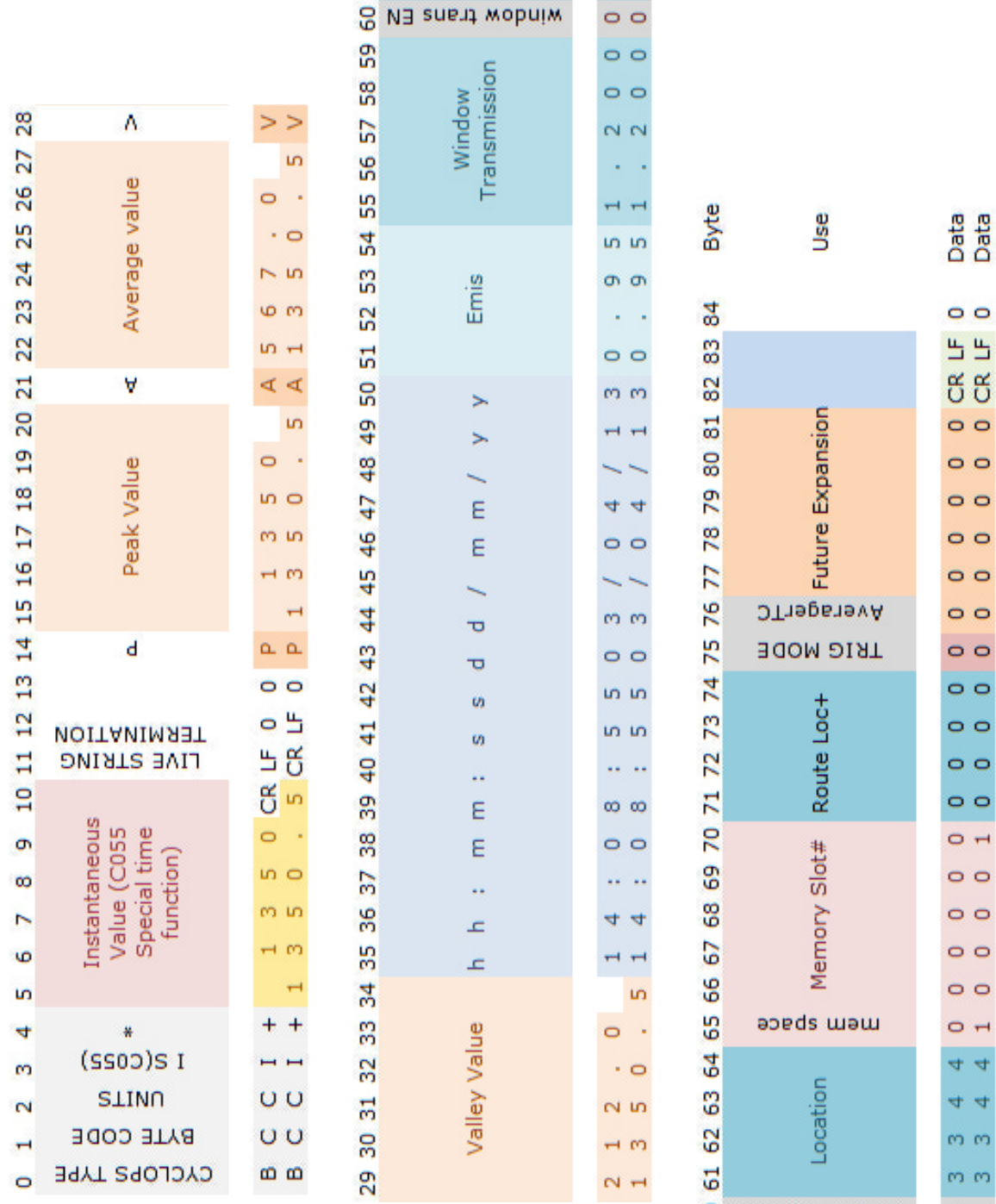

END OF SECTION

PRODUCT WARRANTY

Thank you for purchasing your new product. The manufacturer's 'back-to-base' warranty covers product malfunctions arising from defects in design or manufacture. The warranty period commences on the instrument despatch date from the Land Instruments International Ltd factory in Dronfield, UK.

12 MONTHS WARRANTY

The Cyclops range of instruments has a **12 months** warranty.

EXCLUSIONS FROM WARRANTY

It should be noted that costs associated with calibration checks which may be requested during the warranty period are not covered within the warranty.

The manufacturer reserves the right to charge for service/calibration checks undertaken during the warranty period if the cause is deemed to fall outside the terms of the warranty.

This manufacturer's warranty does not cover product malfunction arising from:-

- incorrect electrical wiring.
- connection to electrical power sources outside the rating of the product.
- physical shock (being dropped, etc.) and impact damage.
- inappropriate support, physical shock & strain protection.
- environmental conditions exceeding the IP / NEMA rating of the product.
- environmental conditions outside the Ambient Temperature, Humidity and Vibration rating of the product.
- environmental contamination (solvent vapours, deposition of airborne contamination, cooling liquids of non-neutral pH, etc.).
- overheating as a result of incorrect installation.
- inappropriate modification of product (drilling holes in thermometer bodies, etc.).
- inappropriate recalibration which results in product calibration being taken outside specification.
- attempted repair by a non-authorized repair centre.

Land Instruments International Ltd • Dronfield S18 1DJ • England • Tel: +44 (0) 1246 417691 • Fax: +44 (0) 1246 410585
Email: land.enquiry@ametek.co.uk • www.landinst.com

AMETEK Land, Inc. • 150 Freeport Rd. • Pittsburgh, PA 15238 • U.S.A. • Tel: +1 (412) 826 4444
Email: irsales@ametek.com • www.ametek-land.com

CYCLOPS

A FAMILY OF HIGH PRECISION PORTABLE
NON-CONTACT THERMOMETERS

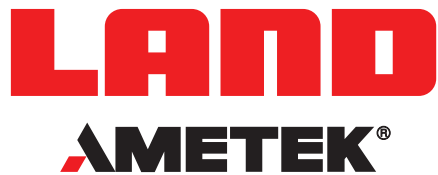

Land Instruments International

Dronfield, S18 1DJ,
England

Tel: +44 (0) 1246 417691

Email: land.enquiry@ametek.co.uk
www.landinst.com

AMETEK Land - Americas

150 Freeport Road, Pittsburgh,
PA 15238, U.S.A.

Tel: +1 (412) 826 4444

Email: irsales@ametek.com
www.ametek-land.com

AMETEK Land China Service

Part A, 1st Floor No. 460
North Fute Road,
Waigaoqiao Free Trade Zone 200131
Shanghai, China

Tel: +86 21 5868 5111 ext 122

Email: land.enquiry@ametek.co.uk
www.landinst.com

AMETEK Land India Service

Divyasree N R Enclave, Block A,
4th Floor, Site No 1, EPIP Industrial Area
Whitefield, Bangalore- 560066
Karnataka, India

Tel: +91 - 80 67823240

Email: land.enquiry@ametek.co.uk
www.landinst.com



0034
Applies in the UK



Applies in the US



Applies in India

For a full list of international offices, please visit our website www.landinst.com

Copyright © 2008-16 LAND Instruments International. Continuous product development may make it necessary to change these details without notice.

Cyclops User Guide, Issue 4, 23 February 2016