

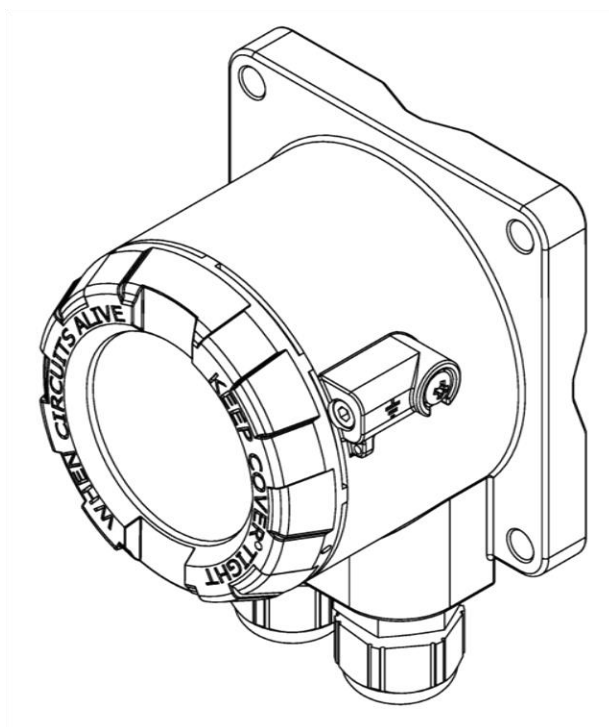

USER'S MANUAL

Display WW-11ALW



PRODUCT CODE – see (→ Display identification).

The QR code or ID number identifies the transmitter and provides quick access to the following documentation on the manufacturer's website: user's manual, declarations of conformity and copies of certificates.

WW-11ALW

ID: 0058 0001 0000 0000 0000 0000 0001 60

<https://www.aplisens.com/ID/005800010000000000000000000160>

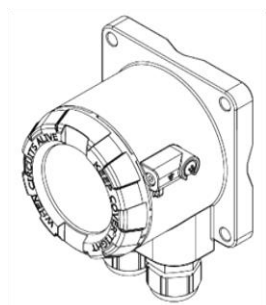



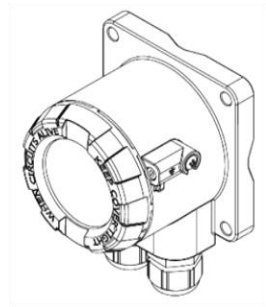

WW-11ALW (Exi)

ID: 0058 0001 0000 0000 0000 0001 0001 11

<https://www.aplisens.com/ID/005800010000000000000001000111>



Symbols used

Symbol	Description
	Warning to proceed strictly in accordance with the information contained in the documentation in order to ensure the safety and full functionality of the device.
	Information particularly useful during installation and operation of the device.
	Information particularly useful during installation and operation of an Ex type device.
	Information on disposal of used equipment.

BASIC REQUIREMENTS AND SAFE USE



The manufacturer will not be liable for damage resulting from incorrect installation, failure to maintain a suitable technical condition of the device or use of the device other than for its intended purpose.

Installation should be carried out by qualified staff having the required authorization to install electrical and I&C equipment. The installer is responsible for performing the installation in accordance with manual as well as with the electromagnetic compatibility and safety regulations and standards applicable to the type of installation.

In systems with I&C equipment, in case of leakage, there is a danger to staff due to the medium under pressure. All safety and protection requirements must be observed during installation, operation and inspections.

If a malfunction occurs, the device should be disconnected and handed over to the manufacturer or an authorized representative for repair.



In order to minimize the risk of malfunction and associated risks to staff, the device is not to be installed or used in particularly unfavourable conditions, where the following hazards occur:

- possible mechanical impacts, excessive shocks and vibration;
- excessive temperature fluctuation;
- water vapour condensation, dusting, icing.

Changes made to the manufacturing of products may be introduced before the paper version of the manual is updated. The up-to-date manuals are available on the manufacturer's website:

www.aplisens.com.

TABLE OF CONTENTS

1. INTRODUCTION	6
2. SAFETY	6
3. TRANSPORT AND STORAGE	7
3.1. Delivery check.....	7
3.2. Transport.....	7
3.3. Storage	7
4. GUARANTEE	7
5. IDENTIFICATION	8
5.1. Manufacturer's address.....	8
5.2. Display identification.....	8
5.3. CE mark, declaration of conformity.....	9
6. CERTIFICATES FOR USE IN HAZARDOUS AREAS	10
6.1. Directive ATEX – intrinsically safe version.....	10
6.2. Allowable parameters for supplying of the displays (based on the certificate KDB 16 ATEX 0006).....	10
7. INSTALLATION	11
7.1. General recommendation	11
8. ELECTRICAL CONNECTION	12
8.1. Cable connection	12
8.2. Cabling specification	12
8.3. Electrical connection of display in safe areas	13
8.4. Electrical connection of display in hazardous areas.....	13
8.5. Earthing.....	14
9. OPERATION	16
9.1. Display configuration	17
9.2. Local Menu, error messages	20
10. MAINTENANCE	21
10.1. Periodic inspections	21
10.2. Non-periodic inspections	21
10.3. Spare parts	21
10.4. Repair	21
10.5. Returns	21
11. SCRAPPING, DISPOSAL	21
12. HISTORY OF REVISIONS	21

LIST OF FIGURES

Figure 1. Nameplate of the display WW-11ALW in standard version. 8
Figure 2. Nameplate of the display WW-11ALW in Exi version. 9
Figure 3. Example of installation of WW-11ALW display on pipe. 11
Figure 4. Connection diagram for WW-11ALW display without HART communication. 12
Figure 5. Connection diagram of WW-11ALW display in the safe zones. 13
Figure 6. Connection diagram of display WW-11ALW in potentially explosive zones. 14
Figure 7. The recommended way to connect earthing for WW-11ALW display. 15
Figure 8. Display information fields. 16
Figure 9. View of disassembled display unit. 16
Figure 10. View of the backlighting jumper of WW-11ALW display in the electronics board (back side of the electronics board). 17
Figure 11. Structure of local setpoints MENU. 18

LIST OF TABLES



Table 1. Allowable parameters for supplying of circuits with display. 10
Table 2. Mounting kit list. 11
Table 3. Table of markings of terminals in terminal block. 12

1. INTRODUCTION

The subject of manual is display type **WW-11ALW**. The manual applies to the standar and intrinsically safe Exi versions.

The manual contains data, tips and general recommendations for safe installation and operation of the display, as well as troubleshooting in case of possible failure.

2. SAFETY

- The installation and start-up of the device and any activities related to the operation shall be carried out after thorough examination of the contents of user's manual;
- installation and maintenance should be carried out by qualified staff having the required authorizations to install electrical equipment and measuring devices;
-  – the device shall be used according to its intended purpose in line with the permissible parameters specified on the nameplate (→ [Display identification](#));
- the protection elements used by the manufacturer to ensure display safety may be less effective if the device is operated in a manner not consistent with its intended purpose;
- before installing or disassembling the device, it is absolutely necessary to disconnect it from the power source;
- no repairs or alterations to the display electronic system are permitted. Assessment of damages and possible repair may only be performed by the manufacturer or authorized representative;
- do not use instruments if damaged. In case of malfunction, the device must be put out of operation;
-  – when using the device in potentially explosive areas, the technical requirements specified in the manual and the applicable local (national) regulations must be observed.

3. TRANSPORT AND STORAGE

3.1. Delivery check

After receiving the delivery of the equipment, it is necessary to:

- make sure that the packaging and its contents were not damaged during transport;
- check the completeness and correctness of the received order, and make sure no parts are missing.

3.2. Transport

Transport of displays shall be carried out with the use of covered means of transport, in original packages. The packaging shall be protected against movement and direct impact of atmospheric factors.

3.3. Storage

Display shall be stored in a factory packaging, in a room without vapours and aggressive substances, protected against mechanical impact.

Allowable range of storage temperature of the display depending on the version:

- standard version: -30...80°C (-22...176°F);
- Ex version: -50...75°C (-58...167°F).

4. GUARANTEE

General terms and conditions of guarantee are available on the manufacturer's website:

www.aplisens.com/ogolne_warunki_gwarancji



The guarantee shall be repealed if the display is used against its intended use, failure to comply with user's manual or interference with the structure of the device.

5. IDENTIFICATION

5.1. Manufacturer's address

APLISENS S.A.
03-192 Warsaw
Morelowa 7 St.
Poland

5.2. Display identification

Depending on the version of the display, the nameplates may differ in the amount of information and parameters.

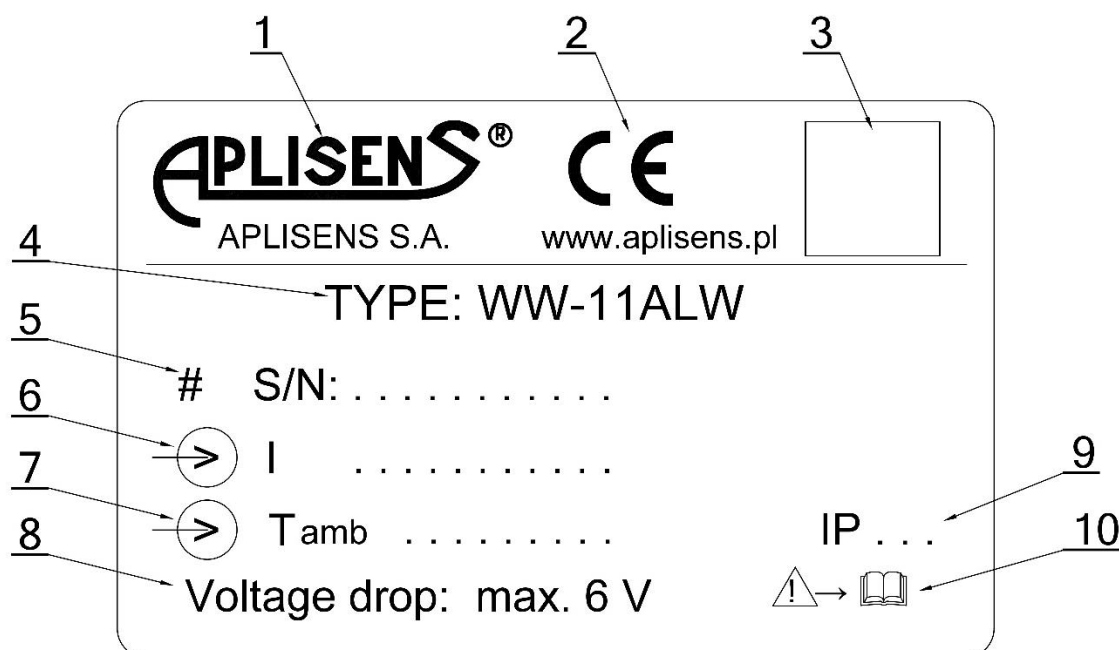

Figure 1. Nameplate of the display WW-11ALW in standard version.

1. Logo and name of the manufacturer.
2. CE mark.
3. Product code.
4. Display type designation.
5. Serial number of the display.
6. Input signal.
7. Permissible range of ambient temperature.
8. Voltage drop.
9. IP protection rating.
10. Note about the obligation to read the manual.

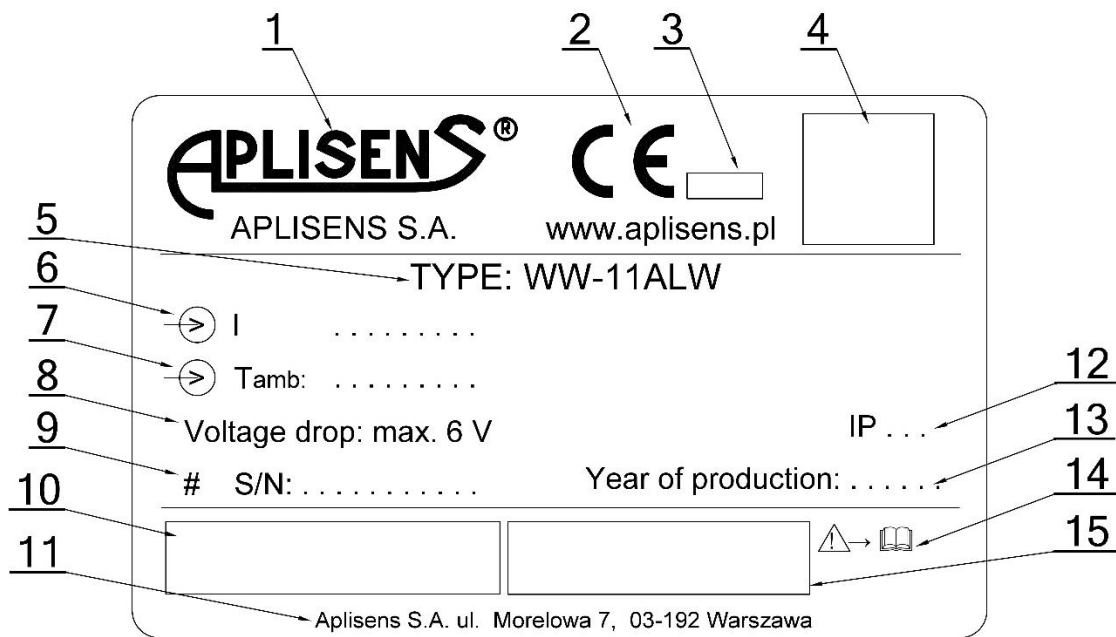

Figure 2. Nameplate of the display WW-11ALW in Exi version.

1. Logo and name of the manufacturer.
2. CE mark.
3. Number of notified body supervising the Ex products.
4. Product code.
5. Display type designation.
6. Input signal.
7. Permissible range of ambient temperature.
8. Voltage drop.
9. Serial number of the display.
10. Marking of type of explosion-proof housing, certificate marking as in p.6.
11. Manufacturer's address.
12. IP protection rating.
13. Year of manufacture.
14. Note about the obligation to read the manual.
15. Input parameter values i.e. U_i , I_i , P_i , L_i , C_i and U_o , I_o , P_o .

5.3. CE mark, declaration of conformity

The device has been designed to meet the highest safety standards, has been tested and has left the factory in a condition that is safe for operation. The device complies with the applicable standards and regulations listed in the EU Declaration of Conformity and has CE marking on nameplate.

6. CERTIFICATES FOR USE IN HAZARDOUS AREAS

6.1. Directive ATEX – intrinsically safe version

Displays may be used in potentially explosive atmospheres in accordance with the following explosion-proof designations:



II 2G Ex ia IIC T4 Gb
II 1D Ex ia IIIC T110°C Da
KDB 16 ATEX 0006

The displays are designed and manufactured in accordance with requirements of the following standards: EN 60079-0:2012 + A11:2013, EN 60079-11:2012.



Connections in potentially explosive zones are presented in p.8.4.
 Allowable parameters based on the KDB 16 ATEX 0006. certificate is given in 6.2.

6.2. Allowable parameters for supplying of the displays (based on the certificate KDB 16 ATEX 0006)



Displays with cooperating transmitters shall be supplied from the supplying devices having appropriate certificates of intrinsic safety, which parameters of outputs to potentially explosive zones shall not exceed allowable supply parameters for the displays.



Table 1. Allowable parameters for supplying of circuits with display.

Allowable parameters for supplying of circuits with display					
Ui, Uo	Ii, Io	Pi, Po	Li	Ci	Ta
Supply with linear characteristics					
30 V	0,1 A	0,75 W	0 μH	25 nF	75°C, T4
Supply with trapezoidal characteristics					
24 V	50 mA	0,6 W	0 μH	25 nF	75°C, T4
Supply with rectangular characteristics					
24 V	50 mA	1,2 W	0 μH	25 nF	75°C, T4

Substitute inductance of transmitter circuit with display $L_{iz} = L_{ip}$
 where L_{ip} - input inductance of the transmitter.

Substitute capacitance C_{iz} of circuit of the transmitter with display equals to:

$C_{iz} = 25 \text{ nF}$ for input capacitance of the transmitter $C_{ip} \leq 25 \text{ nF}$;

$C_{iz} = C_{ip}$ for input capacitance of the transmitter $C_{ip} > 25 \text{ nF}$.

Calculated values of substitute inductance and capacitance of the circuit shall be increased by inductance and capacitance of the cable.

7. INSTALLATION

7.1. General recommendation

WW-11ALW displays are intended for direct mounting on flat surface or on pipe using mounting kit.

In order to mount the display on a flat surface, e.g. a wall, the holes for M6 screws should be prepared for its surface according to the spacing of the holes in the display housing. Then the display shall be fixed to the wall using screws. Mounting on the pipe shall be carried out according to the figure 3.

WW-11ALW display is adapted for assembly on vertical or horizontal pipe with max. diameter $\varnothing 65$ mm. Prism-shape cut outs executed in the rear part of the housing are used for this purpose.

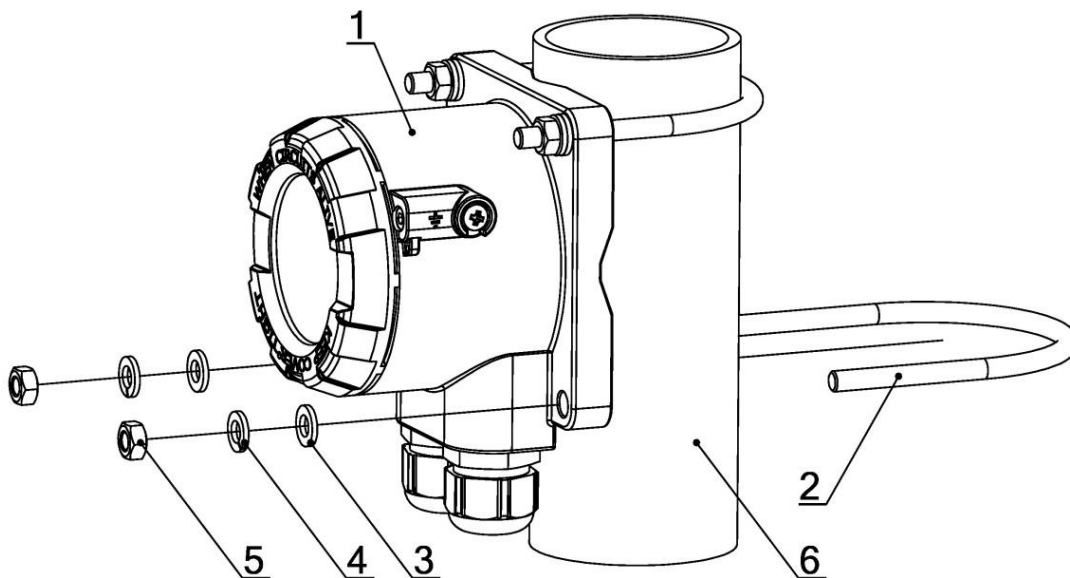

Figure 3. Example of installation of WW-11ALW display on pipe.

Table 2. Mounting kit list.

Item No.	Description	Quantity
1	Display WW-11ALW	1
2	Clamping ring	2
3	Flat washer 6.4	4
4	Spring washer 6.1	4
5	Nut M6	4
6	Pipe	-

The mounting kit includes: clamping rings (2), washers (3), (4) and nuts (5).

Place display on the pipe in the desired position. Place clamping rings (2) in openings in the housing.

Place washers (3) and (4) on the threaded parts of the clamping rings and tighten with nuts (5).

8. ELECTRICAL CONNECTION

8.1. Cable connection



All connecting and installation operations shall be performed with disconnected power supply voltage and other external voltages, if used.



Failure to provide proper connection of the device may result in danger. Risk of electric shock and/or ignition in potentially explosive atmospheres.

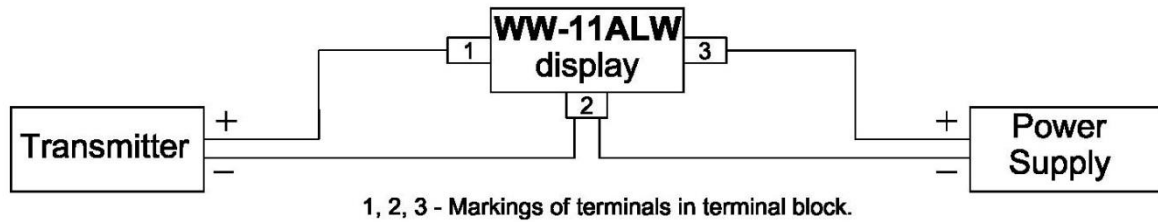

Figure 4. Connection diagram for WW-11ALW display without HART communication.

In the **WW-11ALW** display signal cables shall be led to the housing through cable ducts (cable glands) and shall be connected to terminals (1), (2) and (3) of the terminal block according to the diagram presented on the fig.4, 5 or 6 and the below table containing numbers of the terminals.



Maintain polarity of connection as in the following table.

Table 3. Table of markings of terminals in terminal block.

	Polarization	Terminal number
Power supply	+	3
	-	2
Transmitter	+	1
	-	2

8.2. Cabling specification

Cables:

- unshielded cable is recommended when using only analogue signal;
- shielded cable is recommended for HART communication.

It is recommended to:

- connect display using twisted pair cable or shielded twisted pair cable;
- avoid leading conductors near power cables from the other cable systems;
- use earthing according to the recommendations.

Cross-section of wire of connecting conductor: $\leq 2,5 \text{ mm}^2$.

8.3. Electrical connection of display in safe areas

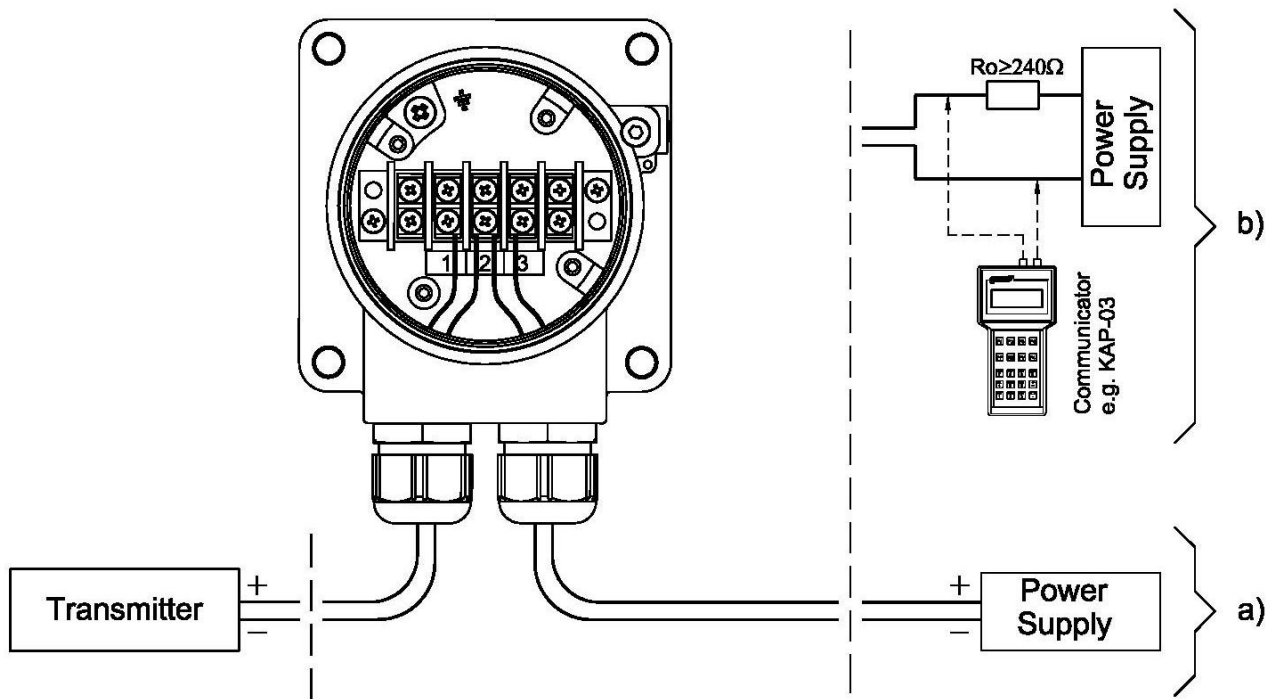

- a) Diagram of connection with transmitter;
- b) diagram of connection with transmitter with Hart communication.

Figure 5. Connection diagram of WW-11ALW display in the safe zones.



In order to communicate with the intelligent transmitter (via HART protocol), before connecting the local communicator or converter, it is necessary to check whether the R_o resistance seen from terminals (2) and (3) of the display towards the power source is in the range $240 \leq R_o \leq 1100 \Omega$.

8.4. Electrical connection of display in hazardous areas



In order to obtain correct cooperation of the display with the rest of the system and assure intrinsic safety conditions it is important to correctly connect the display with particular emphasis on the requirements for the installation of intrinsically safe systems (EN 60079-25, EN 60079-14) and meeting the input/output parameters.



Displays can be supplied from power supply and measurement equipment with relevant intrinsic safety certificates, parameters of which for outputs to potentially explosive areas should not exceed the limits for feeding parameters of displays (permissible parameters of feeding the transmitters in hazardous areas see point 6.2).

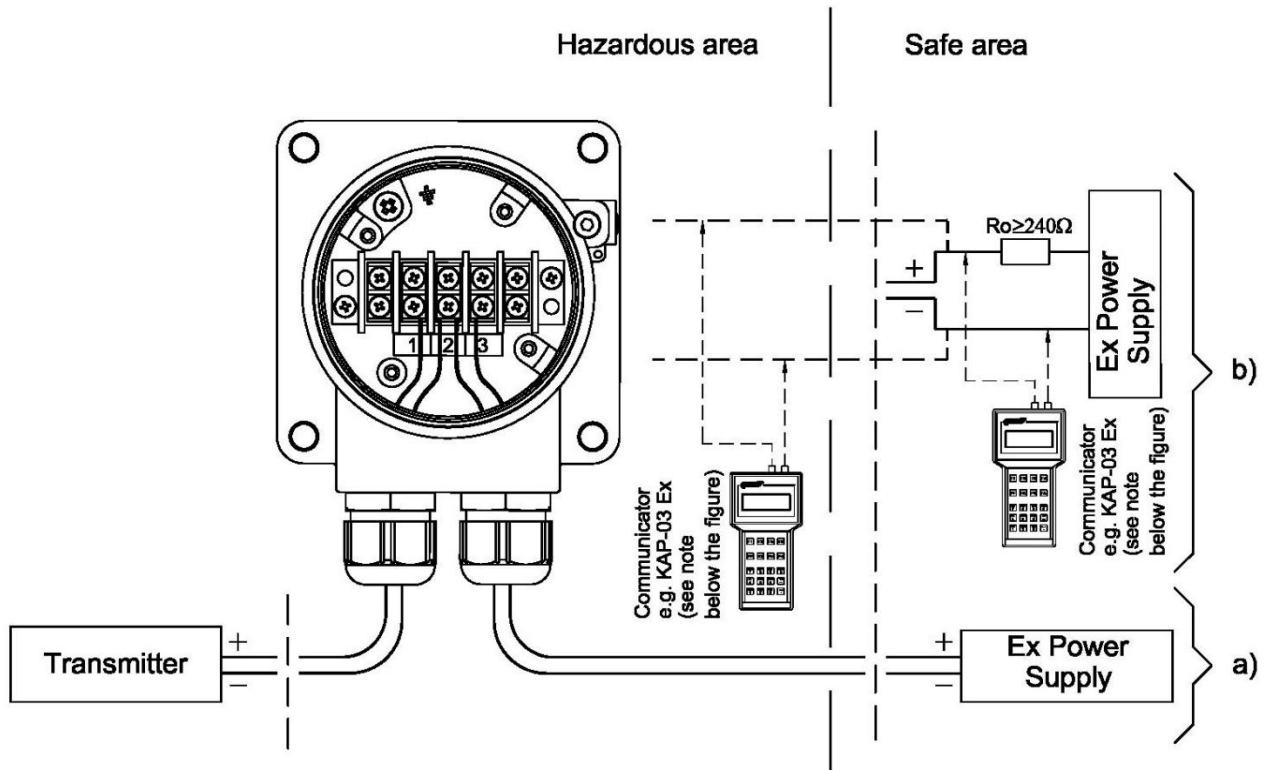

- a) Diagram of connection with transmitter;
- b) Diagram of connection with transmitter with “Hart” communication.

Figure 6. Connection diagram of display WW-11ALW in potentially explosive zones.



Communicator shall have approval for use in the hazardous zone and connecting it to the signal line routed to the hazardous zone. Transmitter shall be configured and calibrated in the safe area when such approval is missing.



In order to communicate with the intelligent transmitter (via HART protocol), before connecting the local communicator or converter, it is necessary to check whether the R_o resistance seen from terminals (2) and (3) of the display towards the power source is in the range $240 \leq R_o \leq 1100 \Omega$.

8.5. Earthing



The display must be earthed in accordance with local electrical standards.

The recommended way to connect earthing for WW-11ALW display is shown in figure 7. Shield of a cable shall be connected from the one side with earth terminal if cable in the shield is used.

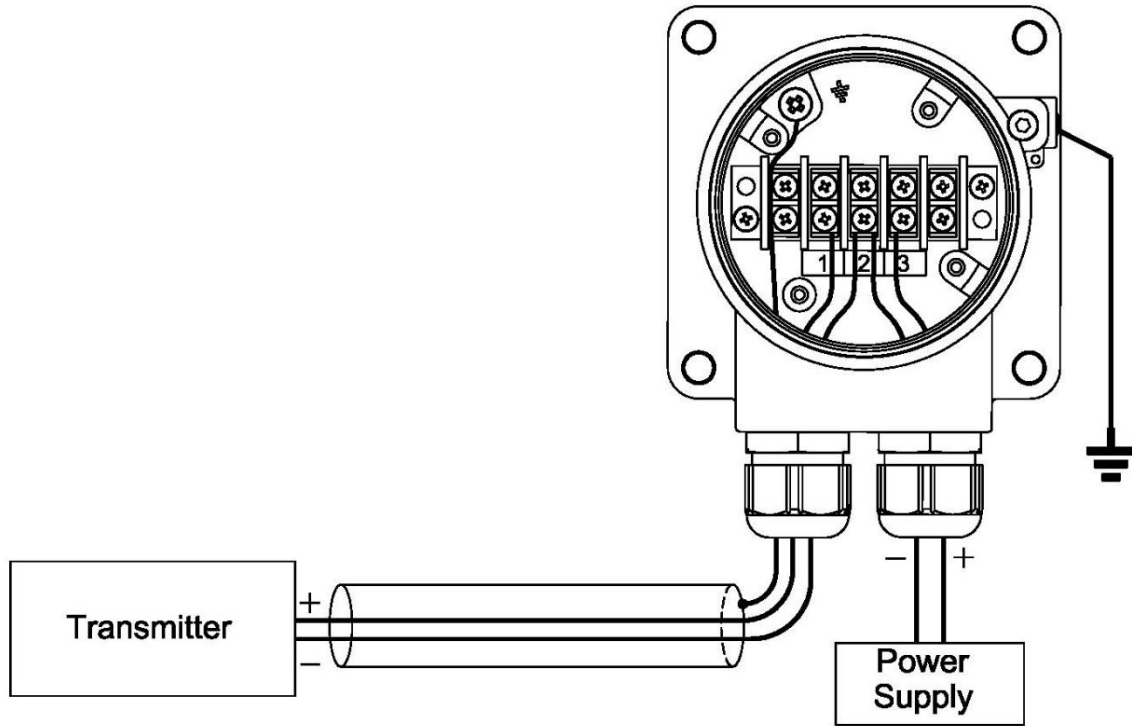

Figure 7. The recommended way to connect earthing for WW-11ALW display.

9. OPERATION

The LCD has three primary information fields in the figure below as LCD1, LCD2, LCD3.

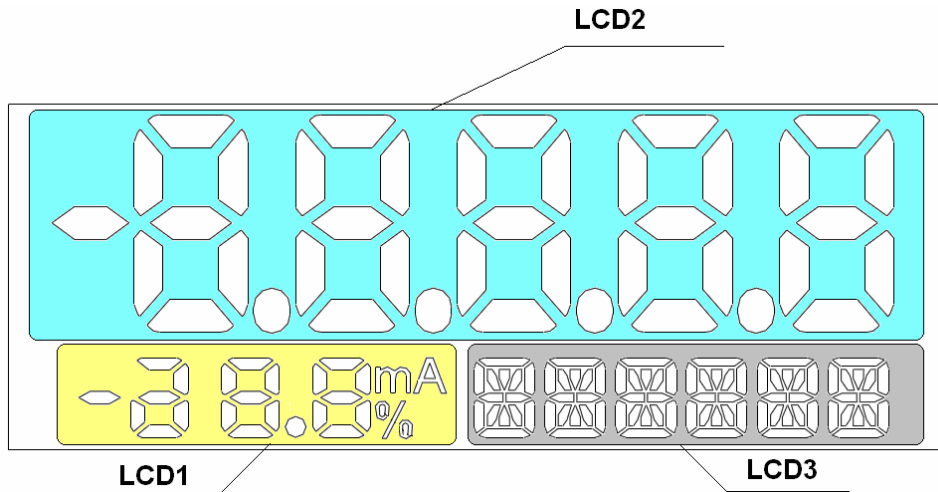

Figure 8. Display information fields.

LCD1 - value of current or guidance percent preset range display. Depending on the display configuration will be displayed the current value of the current line 4...20 mA with a resolution of 0.1 mA, or percent guidance the preset range with a resolution of indications 1%.

LCD2 – display field for the digital value measured by display, the value rescaled by user’s units, and error codes. The position of the decimal point can be set in the local MENU.

LCD3 – information field. During normal operation it is designed for continuous display of the base unit or the user units. In the MENU operation mode it displays the setting options. It is also used to display errors related to the execution of commands in the local setup MENU.

Display backlighting - local display is equipped in backlight which can be switched on or off depending on needs. Switching the backlight on increases the voltage drop for all versions by 3 V. Enable or disable the backlight is possible using the jumper after removing the back cover of the display. The method of switching the backlight on or off is shown in figures below.

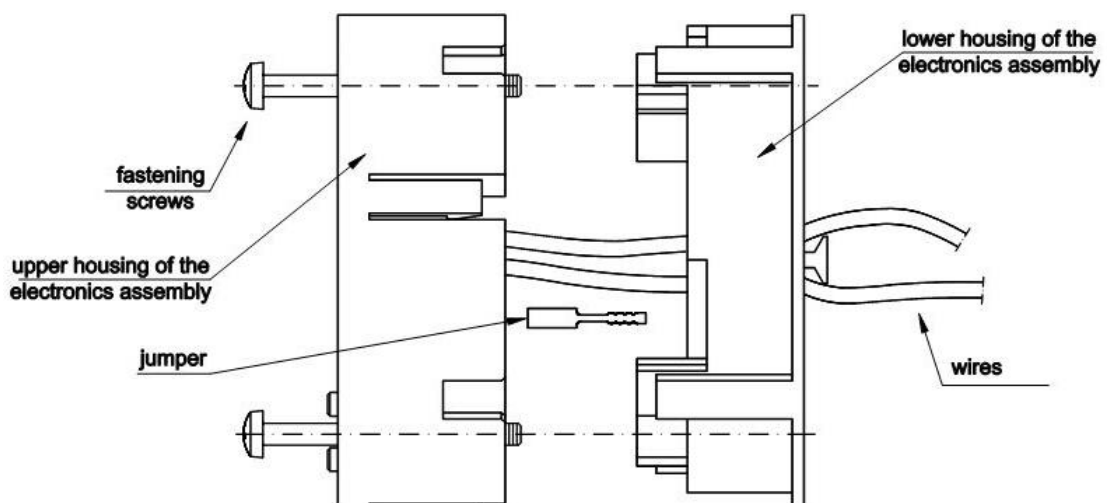

Figure 9. View of disassembled display unit.

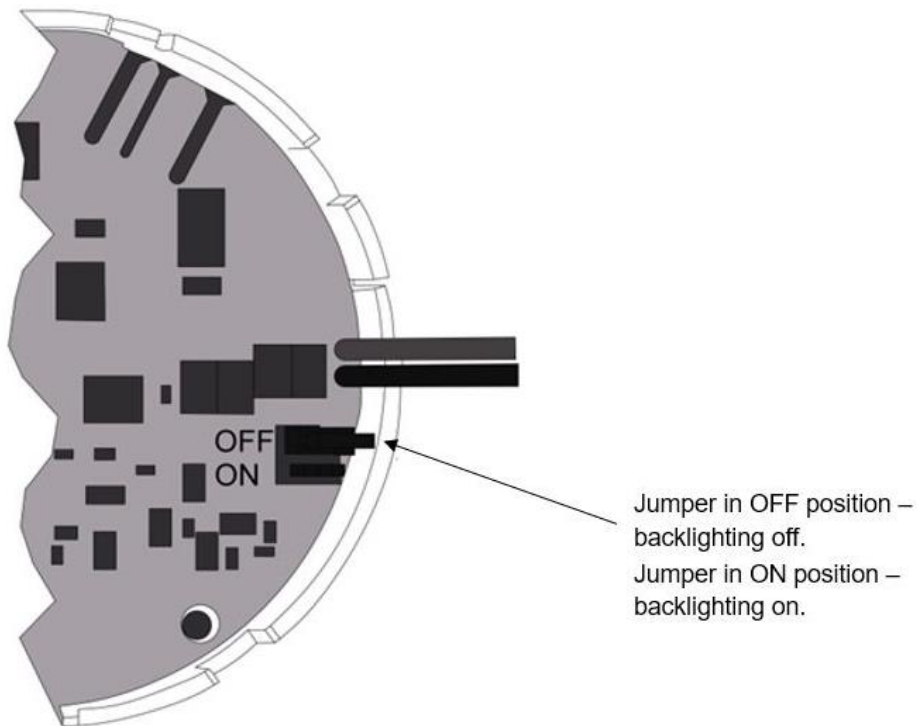

Figure 10. View of the backlighting jumper of WW-11ALW display in the electronics board (back side of the electronics board).

9.1. Display configuration

The user can change the display settings using the buttons below the display. The buttons can be accessed by unscrewing the display cover. The buttons are marked with symbols: [↓], [↑] and [●]. The buttons [↓], [↑] are used to move up and down the MENU structure, and the button [●] confirms and executes the selected option. Pressing and holding any button for about 4 seconds will cause enter to the local setting mode, and the following message "EXIT" appears on the display in the field LCD3. No activity in the MENU area for longer than 2 minutes automatically exits the local setting mode and goes to display process variable. After confirming the selected parameter, the display will confirm the acceptance of the command with a "DONE" message. The "← BACK" button allows to move up a level higher in the MENU structure.

The way of navigating in the MENU structure of the local display is shown in the diagram below.

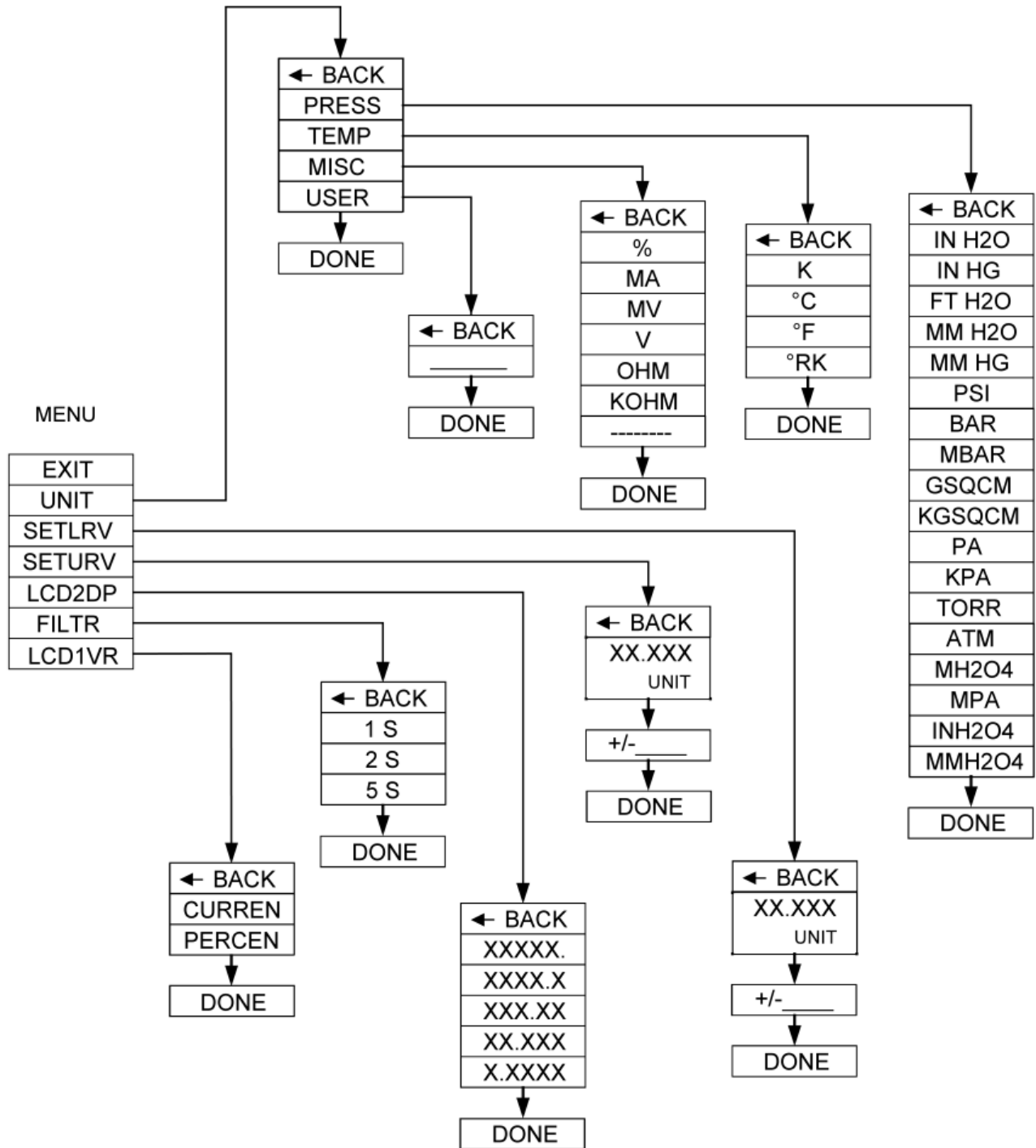
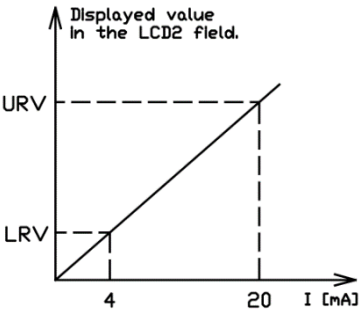

Figure 11. Structure of local setpoints MENU.

Local Menu		Description																
EXIT		Return from Local Menu to display the process variable.																
UNIT		Set up of units.																
	PRESS	Switching to the selection of pressure units.																
	TEMP	Switching to the selection of temperature units.																
	MISC	Switching to the selection of different units.																
	USER	Switching to the user's units entry. Enter the user's unit value (six alphanumeric characters). Buttons "↑" or "↓" are used to select each alphanumeric character of the entered unit. Addition of successive character is made by confirmation of the previous character (by pressing [●] button). After confirmation of the last (6 th) character, the device will confirm the command with "DONE" message or report an error number.																
SET LRV / SET URV		<p>Function allows to assign the given values corresponding to the output signals 4 and 20 [mA]. Value after linear scaling is displayed in the LCD2 field. User can set any value of start and end of the range. By default, the LCD2 field displays the percentage of the measured range.</p>  <p>Table. Exemplary settings LRV, URV</p> <table border="1"> <thead> <tr> <th>Unit</th> <th>LRV</th> <th>URV</th> <th>LCD2</th> </tr> </thead> <tbody> <tr> <td>mA</td> <td>4</td> <td>20</td> <td>Current in current loop</td> </tr> <tr> <td>%</td> <td>0</td> <td>100</td> <td>Output setting percentage - set as a standard</td> </tr> <tr> <td>Measurement range unit (e.g. kPa)</td> <td>Range beginning (e.g. 0)</td> <td>Range end (e.g. 100)</td> <td>Measured physical value (e.g. pressure)</td> </tr> </tbody> </table>	Unit	LRV	URV	LCD2	mA	4	20	Current in current loop	%	0	100	Output setting percentage - set as a standard	Measurement range unit (e.g. kPa)	Range beginning (e.g. 0)	Range end (e.g. 100)	Measured physical value (e.g. pressure)
	Unit	LRV	URV	LCD2														
	mA	4	20	Current in current loop														
	%	0	100	Output setting percentage - set as a standard														
Measurement range unit (e.g. kPa)	Range beginning (e.g. 0)	Range end (e.g. 100)	Measured physical value (e.g. pressure)															
XX.XXX UNIT	Actual value of start and end of the displayed range will be presented. Confirmation of this option allows to assign the given value to the start and end of the displayed range.																	
+/- _____	Entering value of set range. Buttons "↑" or "↓" are used to select entered character. Addition of successive figure is made by confirmation of the previous one (pressing [●] button). Changing the digit or setting a comma is made using button "↑" or "↓". After confirmation of the last (6 th) character, the device will confirm the command with "DONE" message or report an error number. Parameter is entered in UNIT units.																	
LCD2DP	Change the position of the decimal point of variable presented in the LCD2 field of the display.																	
FILTR	Selection of averaging time of displayed process variable.																	
LCD1VR	Type of process variable presented in the LCD1 field of the display.																	
	CURREN	Value of current in current loop will be presented in the LCD1 field.																
	PERCEN	Percentage value of input setting will be presented on the display.																



The WW-11ALW display must be configured or the correctness of indications must be checked after changing the measuring range of the transmitter connected to the display.

9.2. Local Menu, error messages

During perform some functions in Local Menu may appear on LCD2 field an error message EXXXX (the letter E and 4 digits error code). The error message indicates that the Local Menu command has not been executed. The persistence of the error message for a long time indicates malfunction or improper operation of the display.

10. MAINTENANCE

10.1. Periodic inspections

Periodical inspections shall be carried out in accordance with applicable standards. During the inspection, the condition of the electrical connections on terminals (reliability of the connections) and stability of fixing of the display and mounting bracketed (if used) shall be checked.

10.2. Non-periodic inspections

If the display at the installation site has been exposed to mechanical damage, overvoltage or incorrect operation of the display is detected, the device should be inspected.



If there is no signal in the transmission line or its value is improper, check the condition of the cable, connections on the terminals, etc. Check if the supply voltage and load resistance are correct. If the transmission line is in good working order, check the functioning of the display

10.3. Spare parts

Parts of the display, which may be worn or damaged and thus replaced:

Name	Content	Description
Mounting kit	2x clamping rings 4x flat washers 6.4 4x spring washers 6.1 4x nut M6	Figure 3

10.4. Repair

Faulty or non-operational display shall be provided to the manufacturer.

10.5. Returns

In the following cases, display should be returned directly to the manufacturer:

- need for repair;
- replacement of improperly selected/shipped display.

11. SCRAPPING, DISPOSAL



Worn or damaged devices shall be scrapped in accordance with WEEE Directive (2012/19/EU) on waste electrical and electronic equipment or returned to the manufacturer.

12. HISTORY OF REVISIONS

Revision No.	Document revision	Description of changes
-	01.A.001/2015.09	Initial version of document. Developed by DKD.
1	01.A.002/2016.02	ATEX version has been added. Editorial changes. Developed by DKD.
2	01.B.003/2020.09	Editorial changes. Developed by the DBFD.
3	01.B.004/2022.04	QR and ID codes was added. Editorial changes.

