



INSTRUCTION MANUAL



ULTRASONIC LEVEL METERS Ultrapro-500

TABLE OF CONTENTS

1. Safety	4
2. Packing, transportation and storage	4
3. Measuring principle	5
4. Range of application	5
5. Features of variants	5
6. Dimensional drawings	6
7. Installation and putting into operation	6
8. Installation instructions.....	7
9. Electrical connection	10
10. Set-up elements	14
11. Status signalization	15
12. Setting up.....	16
12.1. Setting procedure for level meters UPS-500	16
13. Protocol Modbus	20
14. Order code	20
15. Accessories	21
16. Safety, protection, compatibility and explosion proof.....	21
17. Use, manipulation and maintenance.....	22
18. General conditions and warranty	22
19. Marking of labels.....	23
20. Specifications	24

USED SYMBOLS

In order to provide maximum safety of processes, we have defined the following safety and information instructions. Each of the instructions is marked with an icon.



Alert, warning, danger

This symbol informs about particularly important instructions for installation and operation of the equipment or about dangerous situations that may occur during installation and operation. Failure to comply with the instructions may cause failures, damage or destruction of the equipment, or may cause injuries to persons.



Information

This symbol informs about particularly important characteristics of the equipment.

1. SAFETY



Any operations described in this User's Guide may only be performed by trained personnel or by an authorized person. Warranty and post-warranty repairs shall be performed exclusively on the manufacturer's site.

Improper use, installation or setting of the level meter may lead to crashes in the application (overfilling of the tank or damage to system components).

The manufacturer is not responsible for improper use, work losses resulting from direct or indirect damage and expenses incurred during installation or use of the level meter.

2. PACKAGING, TRANSPORT AND STORAGE

The UPS-500 or UPS-700 device is packed in a cardboard packaging and the whole shipment is placed in a cardboard box. The cardboard box is suitably filled to prevent mechanical damage during transport.

Remove the device from the package just prior to its use to prevent possible damage.

Transport to the customer is provided by a forwarding company. Subject to prior arrangement, personal pick-up of the ordered goods is possible in the company's seat. Upon receipt, please check whether the shipment is complete and corresponds to the extent of the order, or whether during the transport the packaging and the device has not been damaged. Do not use a device apparently damaged during transport and contact the manufacturer to resolve the situation.

If the device is transported further, it shall be wrapped in the original packaging and protected against shocks and weather.

Store the device in its original packaging in a dry place, sheltered from weather, with humidity up to 85% without the effects of chemically active substances. The range of storage temperature is -20°C to +60°C.



Level meters (sensors) of variants UPS are fitted with protective caps to prevent damage to the ultrasonic transducer. Remove the caps before commissioning!

3. MEASURING PRINCIPLE

The UPS Series ultrasonic level sensors are compact measurement devices containing an electro-acoustic transducer and an electronic module. Using the electro-acoustic transducer, level meters and level sensors transmit a series of ultrasonic pulses that spread towards the surface. The transducer then receives the reflected acoustic wave, which is subsequently processed in the electronic module. The current distance to the surface level is calculated from the time of spread of individual pulses towards the surface and back and the temperature measured in the tank. The output is then set on the basis of the surface height. The outputs of the ULM level meter are current 4 - 20 mA, voltage 0 - 10 V and industrial line RS-485 with Modbus RTU communication. The output of the ULS sensor consists of a PNP transistor with an open collector and a two-state current switch 4 mA / 20 mA.

4. RANGE OF APPLICATION

Thanks to the proximity principle employed, the devices are suitable for continuous or limit measurement of the level of liquids, waste water, sludge, suspensions, adhesives, resins in various open and closed vessels, sumps, open channels and drains. Applicability for measuring the surface level of loose materials is limited, the range of measurement is shorter there. Setting is carried out either using two buttons or a magnetic pen or by remote setting in case of Modbus RTU output. The device is equipped with optical indication of its state (RUN) and the setting process (STATE). It is manufactured in designs for normal (N) and explosive atmospheres (Xi).

5. FEATURES OF VARIANTS

- UPS_-53_-01_-** measurement range **0.1 m to 1 m**, all-plastic design, source of PVDF (polyvinylidene fluoride), mechanical connection with thread G ¾.
- UPS_-53_-02_-** measurement range **0.20 m to 2 m**, all-plastic design, source of PVDF, mechanical connection with thread G 1".
- UPS_-53_-06_-** measurement range **0.20 m to 6 m**, all-plastic design, source of PVDF, mechanical connection with thread G 1 ½".
- UPS_-53_-10-** measurement range **0.4 m to 10 m**, all-plastic case, source of PVDF, mechanical connection with thread G 2 ¼".
- UPS_-53_-20-** measurement range **0.5 m to 20 m**, all-plastic case, source of PVDF, mechanical connection with flange of aluminium alloy.

6. DIMENSIONAL DRAWINGS

UPS_53_01_

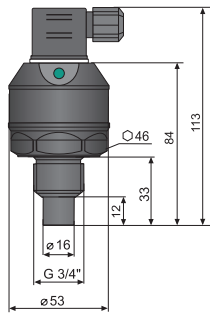

UPS_53_02_

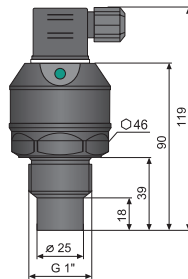

UPS_53_06_

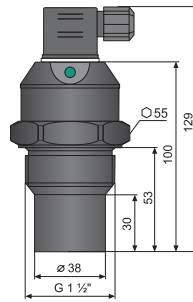

UPS_53_10_

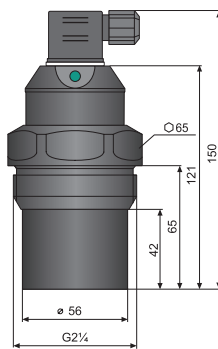

UPS_53_20_

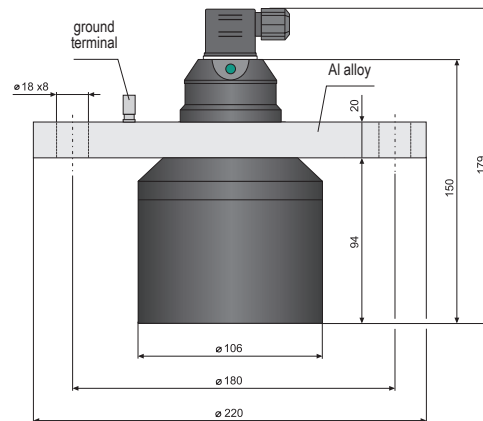

7. INSTALLATION AND PUTTING INTO OPERATION

This procedure includes the following three steps.

- **INSTALLATION**
- **ELECTRIC CONNECTION**
- **SETTING**

8. INSTALLATION INSTRUCTIONS

a) The device is installed in a vertical position into the upper lid of the tank or reservoir using a lug, a fastening nut or a flange in such a way that the axis of the device is perpendicular to the surface level of the measured liquid (Fig. 1). Tightening of the level meter in the welding flange (or. by the fixing nut) is done by hand *. The device shall be installed in places with no risk of **mechanical damage to the front of the sensor**.

b) The minimum dimensional parameters when installing into the lid or the ceiling of the tank are listed in Fig. 3.

c) When installing in an open channel (sump, drain, etc.), install the device onto a console as close as possible to the expected maximum level.

d) The reference plane for the measurement is the lower edge of the transducer (Fig.2). In compliance with the measuring principle, no signals **reflected in the area directly below the device** (dead zone) can be evaluated. The dead zone (Fig. 2) determines the minimum distance possible between the device and the highest level. The minimum distances to the medium are listed in the chapter "Technical specifications".

e) The device shall be installed so that the surface does not interfere with the dead zone when the tank is filled to the maximum. If the measured surface interferes

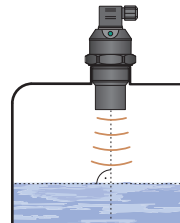

Fig. 1: Correct installation of the sensor, perpendicular to the liquid surface

UPS_-53-01; 02; 10	$d > c/12$ (min. 200 mm)
UPS_-53-06	$d > c/8$ (min. 200 mm)
UPS_-53-20	$d > c/10$ (min. 200 mm)

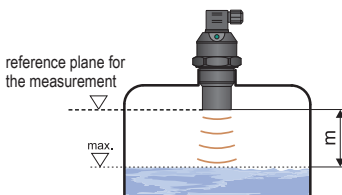

Fig. 2: Dead zone of the device

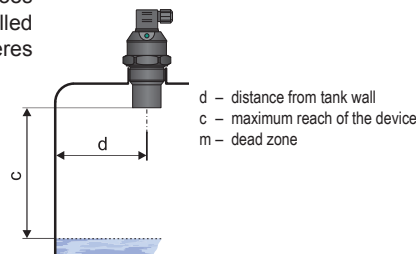

Fig. 3: Distance of the device from the tank wall

with the dead zone, the device **will not measure properly**.

f) If the maximum level in the tank gets into the dead zone, the device shall be mounted into a higher **installation neck**. The tank can be then filled nearly up to the maximum volume. The neck's inner surface shall be even and smooth (without edges and welded joints), the inner edge should be rounded in the spot where the ultrasonic wave leaves the pipe. Choose the largest possible neck diameter, but keep the neck height as low as possible. The recommended dimensions of

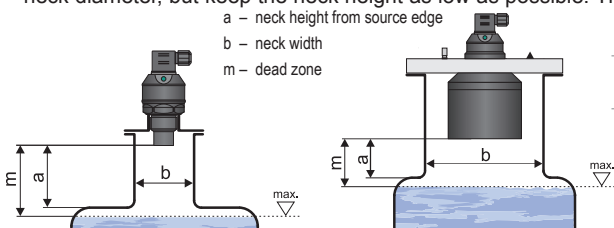

Fig. 4: Installation of the device in the installation neck

UPS_-53-01; 02; 06	$a < 3b$ $b > 100 \text{ mm}$
UPS_-53-10	$a < 1.5b$ $b > 100 \text{ mm}$
UPS_-53-20	$a < 1.5b$ $b > 150 \text{ mm}$

*) To loosen the level meter can be used suitable torque wrench.

- g) **Foam** may be produced on the surface of the measured liquid during filling, mixing and other processes. The thick foam significantly absorbs the ultrasound signal and may cause malfunction of the device (Fig. 5). In those cases it is necessary to test the device in advance and, if necessary, to contact the manufacturer.
- h) The site for installing the level meter needs to be chosen so that the emitted acoustic signal is not affected by **nearby objects** (reinforcements, supports, brackets, ladders, heating elements, mixers, etc.). These obstacles may result in false rebounds,

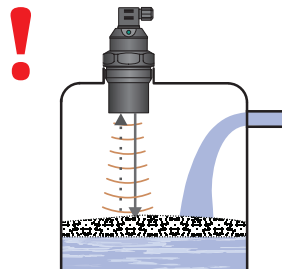

Fig. 5: Thick foam on the surface

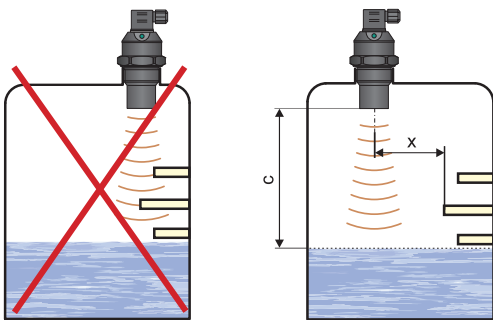

Fig. 6: Minimum distance from close objects in the tank

UPS_-53-01;02;10	$x > c/12$ (min. 200 mm)
UPS_-53-06	$x > c/8$ (min. 200 mm)
UPS_-53-20	$x > c/10$ (min. 200 mm)

x – distance from the edge of the longest object
c – maximum reach of the level meter

increasing measurement inaccuracy (Fig. 6).

- i) Do not install the device in or above the **filling point** (Fig. 7). The measurement could be af-

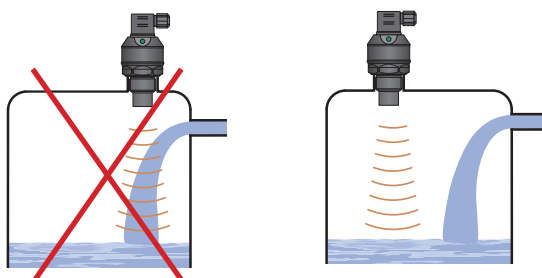

Fig. 7: Installation of the device out of reach of filling circulation

ected by the inflowing medium.

- j) Applicability for measuring the surface level of bulk-solid materials **is limited**, the range of measurement is shorter there. We recommend to consult the suitability of the device for measuring

- k) The measuring device **shall not be installed** in places with direct sunlight and shall be protected against weather conditions.
- l) If installation in places with direct sunlight is inevitable, it is necessary to mount a **shielding cover** above the device (Fig. 8).
- m) It is advisable to keep cable under the **cable gland** (sagging down) as shown in Fig. 9 to prevent penetration of moisture. Rain and condensing water can be therefore drained away freely.
- n) The cable gland as well as the connector shall be **tightened sufficiently** to prevent penetration of moisture.
- o) The ultrasonic signal can be scattered or attenuated if the surface is moderately stirred or rippled (due to a mixer, inflow of liquid, etc.). This may result in **reduction of the measurement range** or unreliable operation of the device (Fig. 10).
- p) False surface reflections of the ultrasonic signal and unreliable operation of the device might result from the mixer's **rotating blades** that ripple the surface level(Fig. 11).
- q) The device should not be installed in places with the risk of **false reflections** of the ultrasonic signal from the mixer's blades (Fig. 12).
- r) **Horn adapter ST-G1** (for UPS-500_-02), **ST-G1,5** (for UPS-500_-06) or **ST-G2,25** (for UPS-500_-10) for improved reception of the transmitted signal can be used in open channels, sumps, tanks, etc.
- s) Horn adapter ST increases the directivity of the emitted acoustic waves, improves the reception of weak echoes (unstable surface level, loose materials) and reduces the risk of false reflections.
- t) The horn adapter is installed on the device via process

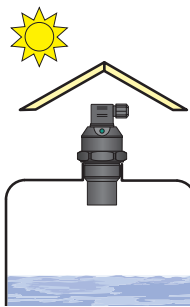

Fig. 8: Shielding cover against direct sunlight

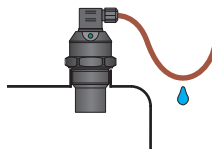

Fig. 9: Protection against penetration of moisture

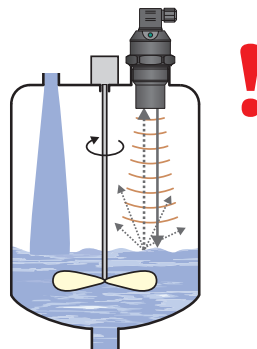

Fig. 10: Moderately stirred surface

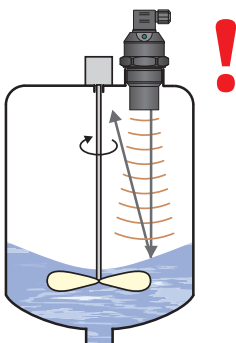

Fig. 11: Strongly stirred surface

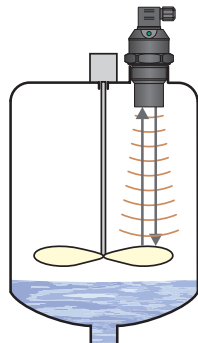

Fig. 12: False reflection from mixer blades

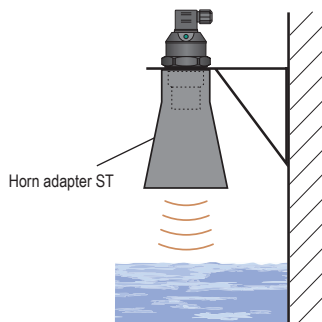

Fig. 13: Horn adapter installation

- If the level sensor is mounted to bottlenecks and places with barriers, or near uneven walls or the filling area, where the transmission signal could be distorted, we recommend using a guide tube (acoustic horn). The tube must be made from a single material with a smooth inner surface (see image 14a, 14b). The minimum tube diameter must have the dimension „b“ according to image 4

Fig. 14a: Short guide tube installation

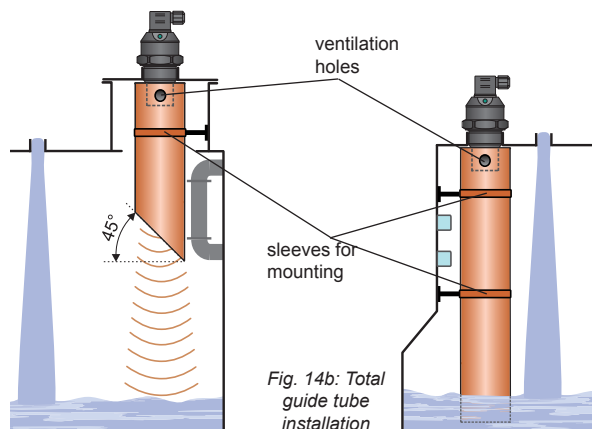

Fig. 14b: Total guide tube installation

9. ELECTRIC CONNECTION

Connection through ISO connector

Valid for: UPS _53 - - - -G-

The UPS level meter or ULS level sensor with a G type cable gland are connected to processing (display) units by means of a cable with an outer diameter of 6 to 8 mm (recommended wire cross-section 0.5 to 0.75 mm²), via a detachable ISO connector with inner screw terminals, which is part of the delivery. The connection diagram and the inner view of the connector are shown in Fig.15 and 16. Non-detachable connector IP67 with PVC cable 5 m long can be supplied as an extra option.

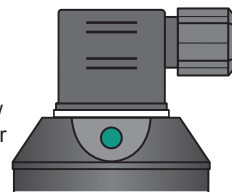

Performance „G“ with connector ISO

Connecting the cable to the device:

- Unscrew the connector from the device using a suitable screwdriver.
- Remove the inner part of the connector using a flat screwdriver (insert the screwdriver in the gap marked with an arrow).
- Unscrew the cable gland and pull the supply cable inside the connector.
- Connect the cable wires to the screw terminals as shown in Fig. 15 (current output 4-20 mA), Fig. 16 (voltage output 0-10 V), Fig. 17 (S type output) or Fig. 18 (P) type output. Tighten the terminals firmly.
- Insert the terminals back in the connector so that the NC terminal points away from the cable gland. Fasten the cable gland.
- Check the sealing on the connector and attach the connector back to the device body.

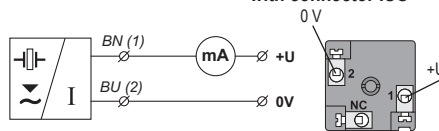

Fig. 15: Connection diagram of the ULM level meter (variant -I) and inside view of the connector

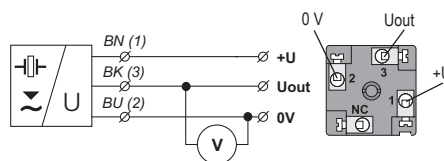

Fig. 16: Connection diagram of the ULM level meter (variant -U) and inside view of the connector

legend:

BK – black BN – brown
BU – blue NC – not connected

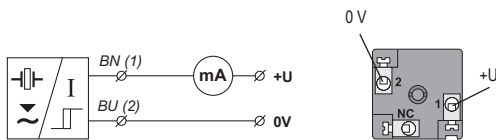

Fig. 17: Connection diagram of the ULS sensor with S type output (two-state current switch 4 mA / 20 mA)

Type **UPS-500_ _ _ _S-G_**
Positive supply pole +U is connected to the brown wire or to connector pin 1, negative pole to the blue wire or to connector pin 2.

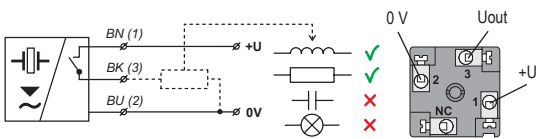

Fig. 18: Connection diagram of the ULS sensor with P type output (PNP) with an open collector

Type **UPS-500_ _ _ _P-G_**
Positive supply pole +U is connected to the brown wire or to connector pin 1, negative pole to the blue wire or to connector pin 2. Load is connected to the black wire or to connector pin 3.

Connection through M12 connector

Valid for: **UPS-53_ _ _ _C_**

The ULM level meter or ULS level sensor with a C type cable gland are connected to processing (display) units by means of a cable with an outer diameter of 4 to 6 mm (recommended wire cross-section 0.5 to 0.75 mm²), via a connector socket with a moulded cable (2 or 5 m long) or via a detachable connector socket without a cable (see accessories). In this case connect the cable to the inner socket pins under Fig. 19.

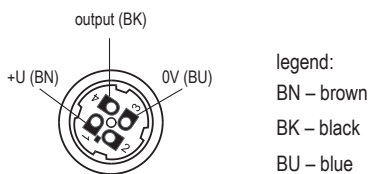
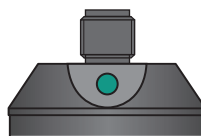

Fig. 19: Inside view of the connector socket



Performance „C“⁴ with connector M12

Type **UPS-500_ _ _ _I-C_**

The positive supply pole +U is connected to connector pin 1 or the brown wire of the connected cable, the negative pole is connected to connector pin 3 or the blue wire of the connected cable.

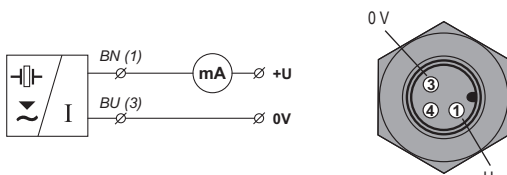

Fig. 20: Connection diagram of the ULM level meter (variant -I) and view of the connector

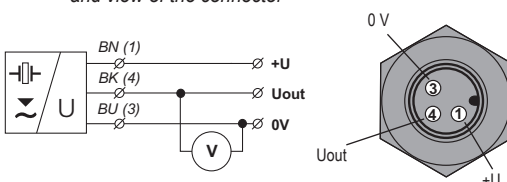

Fig. 21: Connection diagram of the ULM level meter (variant -U) and view of the connector

Type **UPS-500_ _ _ _U-C_**

The positive supply pole +U is connected to connector pin 1 or the brown wire of the connected cable, the negative pole is connected to connector pin 3 or the blue wire of the connected cable. Output voltage is connected to connector pin 4 or the black cable wire.

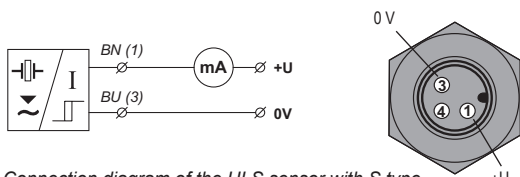

Fig. 22: Connection diagram of the ULS sensor with S type output (two-state current switch 4 mA / 20 mA)

Type **UPS-500_ _ _ _S-C_ _**
The positive supply pole +U is connected to connector pin 1 or the brown wire of the connected cable, the negative pole is connected to connector pin 3 or the blue wire of the connected cable.

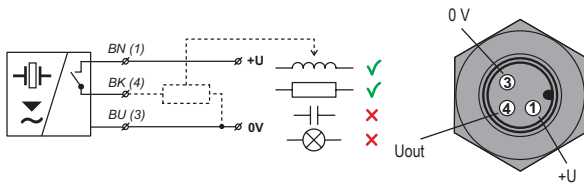

Fig. 23: Connection diagram of the ULS sensor with P type output (PNP) with an open collector

Type **UPS-500_ _ _ _P-C_ _**
The positive supply pole +U is connected to connector pin 1 or the brown wire of the connected cable, the negative pole is connected to connector pin 3 or the blue wire of the connected cable. Load is connected to connector pin 4 or the black cable wire.

Connection via PG 11 gland or gland for protective hoses

The ULM level meter or ULS sensor with a B or H type cable gland are connected to processing (display) units by means of a fixed PVC cable 5 m long. PG 11 (B) or plastic bushings with a thread for protective hoses (H) can be used as a cable gland. Connection diagrams are shown in Fig. 24, 25, 26, 27 and 27.

Valid for: **UPS-53_ _ _ _B(H)_ _**

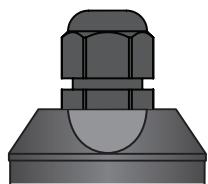

Performance „B“ with short cable gland

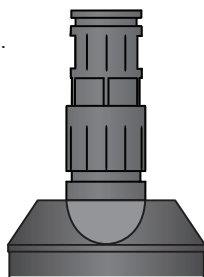

Performance „H“ with cable gland for protective hose



Fig. 24: Connection diagram of the ULM level meter (variant -I)

Type **UPS-500_ _ _ _I-B(H)_ _**

The positive supply pole +U is connected to the brown wire of the connected cable, the negative pole is connected to the blue wire of the connected cable.

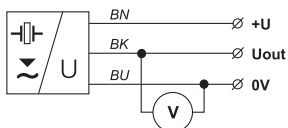

Fig. 25: Connection diagram of the ULM level meter with a voltage output (variant -U)

Type **UPS-500_ _ _ _U-B(H)_ _**

The positive supply pole +U is connected to the brown wire of the connected cable, the negative pole is connected to the blue wire of the connected cable. Output voltage is connected to the black wire of the cable.

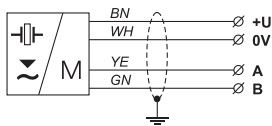

Fig. 26: Connection diagram of the level meter with an RS-485 output (variant -M)

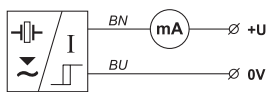

Fig. 27: Connection diagram of the ULS sensor with S type output (two-state current switch 4 mA / 20 mA)

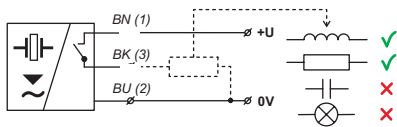

Fig. 28: Connection diagram of the ULS sensor with P type output (PNP) with an open collector

legend:

BK – black WH – white
 BU – blue YE – yellow
 BN – brown GN – green

Type UPS-500_ _ _ _-M-B(H)-_

Level meters are designed for connection to the PLC input (RS-485). The positive supply pole +U is connected to the brown wire of the connected cable, the negative pole is connected to the blue wire of the connected cable. Terminals A and B of line RS-485 are connected to the yellow and green communication wires. The ground terminal of line RS-485 is connected to cable shielding.

Type UPS-500_ _ _ _-S-B(H)-_

The positive supply pole +U is connected to the brown wire of the connected cable, the negative pole is connected to the blue wire of the connected cable.

Type UPS-500_ _ _ _-P-B(H)-_

The positive supply pole +U is connected to the brown wire of the connected cable, the negative pole is connected to the blue wire of the connected cable. Load is connected to the black wire of the cable.



Wiring operations shall only be carried out without voltage!

Taking into account the potential occurrence of electrostatic discharge on non-conducting parts of the level meter, it is necessary to ground the flange of level meters UPS-53Xi-20-F and sensors UPS-53Xi-20-F, located in an explosive atmosphere, using a ground terminal!



It is also necessary to design and take measures to reduce the effects of static electricity to a safe level in the wiring.

Installation in explosive atmospheres needs to be carried out in compliance with EN 60079-14 (Electrical installations for explosive gaseous atmospheres – Part 14: Electrical installations in dangerous areas other than mining) and possibly also in compliance with other standards relating to the area concerned.



The supply source should be preferably designed as a stabilized source of safe voltage 18 V to 36 V DC (max. 30 V DC for version Xi), which is part of the downstream processing or display system.

In case of strong ambient electromagnetic disturbance, parallel run of the input cable with the power line or its length exceeding 30 m, we recommend using a shielded cable.

10. SET-UP ELEMENTS

Device type with setting using buttons

Valid for: UPS_-53_-_-_-_-_-T

DOWN button for UPS (or "OFF" for UPS)

- open the setting mode
- for UPS: direct setting of the value 4 mA (0V)
- for ULS: setting limit for output disconnection
- decrease of values in defined steps

UP button for UPS (or "ON" for UPS)

- open the setting mode
- for UPS: direct setting of the value 20 mA (10V)
- for UPS: setting limit for output connection
- increase of values in defined steps



Fig. 29: Key parts of the measuring device (version with buttons)

Device type with setting using a magnetic pen

Valid for: UPS_-53_-_-_-_-_-M

EMPTY flat area for UPS (or "OFF" for UPS)

- open the setting mode
- for UPS: direct setting of the value 4 mA (0V)
- for UPS: setting limit for output disconnection

FULL flat area for UPS (or "ON" for UPS)

- open the setting mode
- for UPS: direct setting of the value 20 mA (10V)
- for UPS: setting limit for output connection

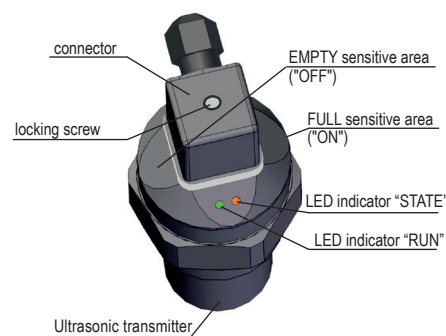

Fig. 30: Key parts of the measuring device (version with Hall probes)

11. STATUS INDICATION

LED indicator	Colour	Function
"RUN"	green	<p>short flashing (repeated depending on the measurement interval approx. 1 ... 2 s) - correct function, receipt of signal (echo) reflected from the measured surface</p> <p>fast flashing – the measured surface is in the dead zone of the level meter or the ultrasound transducer is dirty</p> <p>off – the level meter is not capable of receiving the echo. Incorrect installation or malfunction</p>
"STATE"	orange	<p>UPS-500</p> <p>Setting indication</p> <ul style="list-style-type: none"> • slow flashing – 4 mA (0V) threshold setting indication • fast flashing – 20 mA (10V) threshold setting indication • 3 short flashes – setting confirmation <p>UPS-700</p> <p>Output status indication</p> <ul style="list-style-type: none"> • off – sensor output is disconnected (OFF) • on – sensor output is connected (ON) <p>Setting indication</p> <ul style="list-style-type: none"> • slow flashing – setting indication for the disconnected status • fast flashing – setting indication for the connected status • 3 short flashes – setting confirmation <p>UPS-500 variant "M" with Modbus communication</p> <ul style="list-style-type: none"> • fast flashing – communication under way on line RS-485

12. SETTING

The level meter works most often in its default mode for level measurement (Fig. 31) and only rarely in the inverse mode.

The manual device shall be set up after installation using the DOWN and UP buttons (for version "T") or by applying the magnetic pen onto sensitive flat areas (for version "M"). The set-up process is indicated by the STATE indicator lamp.

The L version level meter does not have any setting controls and indication LEDs. Pre-defined ranges are factory set (applicable to current and voltage outputs).

The level meter variant with a Modbus type output is set by means of two-way communication via the RS-485 industrial bus with the Modbus RTU protocol. A list of applicable registers is given in a separate appendix. To set up the level meter and collect measured data, you can use the software application „Basic SCADA level“, which is freely available at the Website www.iconprocon.com

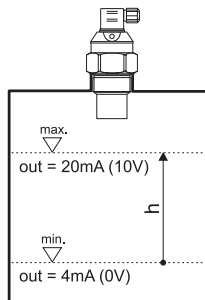

Fig. 31: Default mode (level measurement)

12.1. PROCEDURE MANUAL SETTING OF LEVEL METER UPS Series

Connect the level meter to the supply source. Check the output value - current or voltage - using the measuring device or a connected instrument.

12.1.1. Setting using buttons (version "T")

a) Basic mode (*level measurement*)

Setting of lower limit 4 mA (0 V)

1. Drain the tank to the lower measured surface level.
2. Press the DOWN button for at least 2 s to activate the setting mode (the STATE indicator LED flashes slowly). Keep the DOWN button pressed for at least additional 3 s to set the value to 4 mA (0 V) directly. In that case you can skip step 3.
3. Press the DOWN and UP buttons to accurately set any value in individual increments (hold the relevant button to increase the adjustment step gradually).
4. Press both buttons simultaneously for at least 1 s to confirm the set values. The STATE indicator LED briefly flashes three times.
5. Any other setting is possible 2 s after both buttons are released.

Setting of upper limit 20 mA (10 V)

1. Fill the tank up to the upper measured surface level.
2. Press the UP button for at least 2 s to activate the setting mode (the STATE indicator LED flashes quickly). Keep the UP button pressed for at least additional 3 s to set the value to 20 mA (10 V) directly. In that case you can skip step 3.
3. Press the DOWN and UP buttons to accurately set any value in individual increments (hold the relevant button to increase the adjustment step gradually).
4. Press both buttons simultaneously for at least 1 s to confirm the set values. The STATE indicator LED briefly flashes three times.
5. Any other setting is possible 2 s after both buttons are released.

Factory default settings

1. Disconnect the level meter from supply voltage (e.g. by disconnecting the connector).
2. Press the DOWN and UP buttons at the same time while supply voltage is disconnected.
3. Connect supply voltage while keeping the DOWN and UP buttons pressed.
4. Wait approx. 4 s for 3 short flashes of the orange STATE indicator LED. After that, release both buttons.
5. Now the level meter is restored into factory default settings.

b) Inverse mode

In the inverse mode, set the lower limit of 4 mA (0V) when the tank is filled up to the upper measured surface level and the upper limit of 20 mA (10V) when the tank is drained to the lower measured surface level .

12.1.2. Setting using a magnetic pen (version "M")

a) Basic mode (level measurement)

Setting of lower limit 4 mA (0V)

1. Drain the tank to the lower measured surface level.
2. Set the level meter output to the value of 4 mA (0 V) by applying the magnetic pen to the EMP-TY sensitive area for at least 2 s. The STATE indicator LED flashes slowly. Hold the magnetic pen on the flat area for at least additional 3 s to confirm the set value and store it in the internal memory of the level meter. The STATE indicator LED briefly flashes three times.
3. Any other setting is possible 2 s after the magnetic pen is removed from the sensitive area.

Setting of upper limit 20 mA (10V)

1. Fill the tank up to the upper measured surface level.
2. Set the level meter output to the value of 20 mA (10V) by applying the magnetic pen to the FULL sensitive area for at least 2 s. The STATE indicator LED flashes slowly. Hold the magnetic pen on the flat area for at least additional 3 s to confirm the set value and store it in the internal memory of the level meter. The STATE indicator LED briefly flashes three times.
3. Any other setting is possible 2 s after the magnetic pen is removed from the sensitive area.

Factory default settings

1. Disconnect the level meter from supply voltage (e.g. by disconnecting the connector).
2. While there is no supply voltage, apply the magnetic pen on one of the sensitive areas.
3. Connect supply voltage and keep the magnetic pen in position.
4. Wait approx. 4 s for 3 short flashes of the orange STATE indicator LED. You can remove the magnetic pen.
5. Now the level meter is restored into factory default settings. See the table on page 25.

b) Inverse mode

In the inverse mode, set the lower limit of 4mA (0V) when the tank is filled up to the upper measured surface level and the upper limit of 20mA (10V) when the tank is drained to the lower measured surface level see Fig. 32.

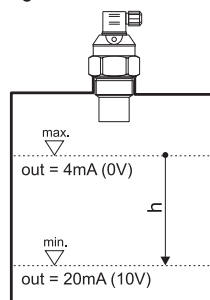

Fig. 32: Inverse mode

12.2. PROCEDURE MANUAL SETTING OF SENSOR UPS-500

The UPS sensor can work in two modes:

a) Mode O (closed output when the maximum level is exceeded)

- the sensor output is closed when the level rises to the upper set point
and open when the level drops to the lower set point

b) Mode C (open output when the maximum level is exceeded)

- the sensor output is open when the level rises to the upper set point
and closed when the level drops to the lower set point

Connect the sensor to the power supply. Check the status of the sensor output - connected or disconnected - using a connected device.

12.2.1. **Setting using buttons** (version "T")

a) Mode O (*closed output when the maximum level is exceeded*)

Setting of open output

1. Drain the tank to the lower measured surface level.
2. Open the sensor output by pressing the OFF button for at least 2 s. The STATE indicator LED flashes slowly. Keep the OFF button pressed for at least additional 3 s to confirm the set value and store it in the internal memory of the level meter. The STATE indicator LED briefly flashes three times. You can also press both buttons simultaneously for at least 1 s to confirm the set values.
3. Any other setting is possible 2 s after the button is released (buttons are released).

Setting of closed output

1. Fill the tank up to the upper measured surface level.
2. Close the sensor output by pressing the ON button for at least 2 s. The STATE indicator LED flashes quickly. Keep the ON button pressed for at least additional 3 s to confirm the set value and store it in the internal memory of the level meter. The STATE indicator LED briefly flashes three times. You can also press both buttons simultaneously for at least 1 s to confirm the set values.
3. Any other setting is possible 2 s after the button is released (buttons are released).

Factory default settings

1. Disconnect the sensor from supply voltage (e.g. by disconnecting the connector).
2. Press the OFF and ON buttons at the same time while supply voltage is disconnected.
3. Connect supply voltage while keeping the OFF and ON buttons pressed.
4. Wait approx. 4 s for 3 short flashes of the orange STATE indicator LED. After that, release both buttons.
5. Now the level meter is restored into factory default settings.

b) Mode C (*open output when the maximum level is exceeded*)

In mode C, set the open status when the tank is filled up to the upper measured surface level and the closed status when the tank is drained to the lower measured surface level.

12.2.2. Setting using a magnetic pen (version "M")

a) Mode O (closed output when the maximum level is exceeded)

Setting of disconnected output

1. Drain the tank to the lower measured surface level.
2. Open the sensor output by placing the magnetic pen to the OFF sensitive area for at least 2 s. The STATE indicator LED flashes slowly. Hold the magnetic pen on the OFF flat area for at least additional 3 s to confirm the set value and store it in the internal memory of the level meter. The STATE indicator LED briefly flashes three times.
3. Any other setting is possible 2 s after the magnetic pen is removed from the sensitive area.

Setting of connected output

1. Fill the tank up to the upper measured surface level.
2. Closed the sensor output by placing the magnetic pen to the ON sensitive area for at least 2 s. The STATE indicator LED flashes quickly. Hold the magnetic pen on the ON flat area for at least additional 3 s to confirm the set value and store it in the internal memory of the level meter. The STATE indicator LED briefly flashes three times.
3. Any other setting is possible 2 s after the magnetic pen is removed from the sensitive area.

Factory default settings

1. Disconnect the sensor from supply voltage (e.g. by disconnecting the connector).
2. While there is no supply voltage, place the magnetic pen on one of the sensitive areas.
3. Connect supply voltage and keep the magnetic pen in position.
4. Wait approx. 4 s for 3 short flashes of the yellow STATE indicator LED. After that, release both buttons.
5. Now the level meter is restored into factory default settings. See the table on page 25.

b) Mode C (open output when the maximum level is exceeded)

In mode C, set the open status when the tank is filled up to the upper measured surface level and the closed status when the tank is drained to the lower measured surface level.



If the surface level is within the dead zone (the RUN indicator LED flashes quickly), the setting mode is terminated immediately and will be inaccessible until the level leaves the dead zone.

If no button is pressed in the setting mode within 20 s, the measurement mode of the level meter will be restored. The newly set values will not be saved.

