

This instruction manual concerns the OM 21 and OM 23 units having the software version > E.00

1. INTRODUCTION 3	5.5 SELECTING OPERATING MODES10
	5.5.1 4-wires principle10
	5.5.2 Selecting measurement current11
	5.5.3 Selecting rated voltage11
	5.5.4 Selecting current waveform11
	5.6 MEASUREMENT CYCLE12
	5.6.1 Standby position12
	5.6.2 OPER command12
	5.6.3 HOLD position12
	5.6.4 External trigger command13
	5.6.5 Operating diagrams13
	5.7 OTHER FUNCTIONS13
	5.7.1 Relative measurement (ΔR)13
	5.7.2 Relative measurement ($\Delta R / R$)13
	5.7.3 Analog limits (clamping)14
	5.7.4 Alarms14
	5.7.5 Temperature compensation14
	5.7.6 Heating measurement14
	5.8 MEASUREMENT MEMORY15
	5.8.1 Immediate measurement clearing15
	5.8.2 Statistics on the last burst15
	5.8.3 Displaying bursts16
2. CHARACTERISTICS 3	6. PROGRAMMING 17
2.1 APPLICABLE STANDARDS 3	6.1 KEYPAD PROGRAMMING FUNCTIONS17
2.1.1 Safety class 3	6.2 ACCESSING A FUNCTION - CHOOSING A PROCEDURE17
2.1.2 EMC conformity 3	6.2.1 Summary of the different programming procedures17
2.1.3 Environmental requirements 3	6.3 GENERAL PROGRAMMING PROCEDURE18
2.1.4 Mechanical specifications 3	6.4 PROGRAMMING PROCEDURES19
2.1.5 Reference measurement conditions 3	6.4.1 Alarms19
2.1.6 Resistance measurements 3	6.4.2 Resistance per kilometer19
2.1.7 IEEE-488 interface 3	6.4.3 Saving the measurement configuration20
2.1.8 RS 232-D interface 3	6.4.4 Resetting the protected memory20
2.2 GENERAL SPECIFICATIONS 3	6.4.5 Erasing the burst memory20
2.3 MEASUREMENT SPECIFICATIONS 4	6.4.6 Calibration date20
2.3.1 Conventions 4	6.4.7 Calibration20
2.3.2 Ranges 4	6.4.8 Printer20
2.3.3 Accuracy 4	6.4.9 Interface21
2.3.4 Additional specifications 4	6.4.10 Language22
2.3.5 Other specifications 5	6.4.11 Instrument identity22
3. MEASUREMENT ACCESSORIES 5	6.4.12 Analog output22
3.1 DELIVERED WITH THE UNIT 5	6.4.13 Alternate current mode23
3.2 OPTIONAL ACCESSORIES 5	6.4.14 External current measurement23
4. INSTRUCTIONS BEFORE USE 6	6.4.15 Relative measurements (ΔR , $\Delta R/R$)23
4.1 UNPACKING 6	6.4.16 Temperature programs24
4.2 RETURN 6	6.4.17 Measurement cycle24
4.3 INSTRUCTIONS BEFORE SWITCHING ON 6	6.4.18 Analog limit (clamping)25
4.4 CONTROLS 6	7. IEEE-488 AND RS 232 INTERFACES26
4.4.1 Front panel 6	7.1 INTRODUCTION26
4.4.2 Rear panel 6	7.2 SYNTAX26
4.4.3 Tilt handle position 7	7.2.1 Command messages26
4.5 PANEL OR RACK MOUNTING 7	7.2.2 Response messages26
4.5.1 Panel cut-out 7	7.2.3 Detecting remote control errors27
4.5.2 Panel mounting 7	7.2.4 Instrument registers, service request27
4.6 CONNECTIONS 7	7.2.5 Input buffer28
4.6.1 Internal current source 7	7.2.6 Output buffer28
4.6.2 OM 21/OM 23 external current source 8	7.2.7 Exception procedures29
4.6.3 Temperature probe 8	7.2.8 Sequential and overlapped commands - commands ignored in local29
4.6.4 Trigger command 8	7.3 UNIT REMOTE COMMANDS29
4.6.5 Safety terminal 8	7.3.1 Commands defined by IEEE-488.2 standard29
4.6.6 Analog output 8	7.3.2 Specific RS 232 mode commands30
4.6.7 Alarm outputs 8	7.3.3 Commands affecting unit specific registers30
4.6.8 RS 232 Plug 8	
4.6.9 3 V, 10 A external source for OM 21 8	
5. OPERATION 9	
5.1 SAFETY INSTRUCTIONS 9	
5.1.1 Safety standards compliance 9	
5.1.2 Following instructions supplied with the accompanying documents 9	
5.1.3 Making measurements 9	
5.1.4 Faults and abnormal forces 9	
5.1.5 Definitions 9	
5.1.6 Maintenance 9	
5.2 SWITCHING ON 10	
5.3 ERROR MESSAGES 10	
5.3.1 Display 10	
5.3.2 Audible warning (beep) 10	
5.4 USING THE SECONDARY FUNCTION KEY 10	

7.3.4 Commands affecting working characteristics	30
7.3.5 Commands affecting the measurement cycle	31
7.3.6 Commands affecting other functions.....	32
7.3.7 Commands affecting the burst memory	34
7.3.8 Error commands.....	36

8. MAINTENANCE 37

8.1 OPENING THE UPPER AND LOWER COVERS	37
8.2 CLOSING THE CASE	37
8.3 REPLACING FUSES.....	37
8.3.1 Power fuse	37
8.3.2 Current circuit fuse	37
8.4 POWER SUPPLY 230 V OR 115 V	37
8.5 SERVICING THE BATTERY PACK (OM 21).....	37
8.5.1 Normal usage.....	37
8.5.2 Storage.....	38
8.5.3 Replacing the battery pack.....	38
8.6 EXTERNAL POWER SUPPLY (OM 21)	38
8.7 PERFORMANCE VERIFICATION	38

9. WARRANTY 38

**10. APPENDIX I - SUMMARY OF THE SPECIFIC
COMMANDS 39**

DECLARATION OF CONFORMITY 43

1. Introduction

The OM 21 and OM 23 are versatile micro-ohmmeters, combining high resolution and accuracy with ease of use. They measure from 0,1 $\mu\Omega$ up to 26 k Ω (OM 21) and from 1 $\mu\Omega$ to 260 k Ω (OM 23) with an accuracy of 0.03 %.

Main applications:

- contact resistance measurement with or without voltage limits (20 mV or 50 mV);
- ground continuity and cable resistance measurements;
- inductive resistance measurements in transformers, alternators, etc.;
- quotient measurements using a current source and external resistance standard.

The design features two microprocessors, offering the following advantages:

- automatic calibration with no internal adjustments needed;
- automatic compensation for stray electro-magnetic fields;
- measurement control and processing via RS 232-D (standard) or IEEE-488 (optional) interfaces.

The OM 21 can operate from an optional built-in battery pack with charger.

Versions available:

- OM 21-1: Basic model (power supply and RS 232).
- OM 21-2: Basic model with battery and charger.
- OM 21-3: Basic model with IEEE-488 interface.
- OM 21-4: Basic model with battery, charger and IEEE-488 interface.
- OM 23-1: Basic model.
- OM 23-3: Basic model with IEEE-488 interface.

2. Characteristics

2.1 APPLICABLE STANDARDS

2.1.1 Safety class

In accordance with European Norm EN 61010-1.
Category III, pollution 2.
Isolating voltage: 50 V.

The unit should not be used at altitude above 2 500 m.

Note 1: applicable safety instructions can be found in paragraph 5.1

2.1.2 EMC conformity

The unit performances meet the standards following:
Conducted and radiated disturbances: EN 55022/1994, class B.
Immunity: EN 50082-1/1992.

Radiated: IEC 801-3/1984. Conducted: IEC 801-4/1988.
Electrostatic discharges: IEC 801-2/1991.

2.1.3 Environmental requirements

In accordance with IEC Publication 359 (national standards NF C 42-600, DIN 43745): operating category I.

Reference range:

23°C \pm 1°C, relative humidity: 45 % to 75 %.

Normal operating range:

0°C to + 50°C, relative humidity: 20 % to 80 % non-condensing.

Operating range limits:

- 10°C to + 50°C, relative humidity: 10 % to 80 % non-condensing.

Limits for storage and transport:

- 30°C to + 55°C (- 15°C to + 50°C for model with battery).

2.1.4 Mechanical specifications

Water resistant according to IEC Publication 529 (national standard NF C 20-010): IP 40.

Vibration: according to IEC 68-2-6.

Shock: according to European norm EN 61010-1.

2.1.5 Reference measurement conditions

In accordance with IEC Publications 359 and 485 (national standards NF C 42-630 and DIN 43751).

2.1.6 Resistance measurements

Electrical continuity and contact resistance: tests in accordance with IEC Publication 512-2, DIN 41640 ch. 4.

Ground continuity: in accordance with GAM-EG13, ch. 61.

2.1.7 IEEE-488 interface

In accordance with IEC 625-1 and 625-2 Publications (national standards NF C 42-910 and NF C 42-911, DIN IEC 625-1 and DIN IEC 625-2) and American standard IEEE-488.2.

2.1.8 RS 232-D interface

In accordance with ANSI EIA-232-D-1986 standard.

2.2 GENERAL SPECIFICATIONS

- Languages available: English, French, German, Spanish, Italian.
- 22-key pad covering all operating and programming functions.
- Audible warning (beep) of any incorrect operation when programming. Display of error messages in case of overload, overrange or incorrect connections.
- Measurement terminals duplicated on rear for rack mount operation.
- Alphanumeric liquid crystal display with built-in lighting.
- Direct reading of measurement and units: $\mu\Omega$, m Ω , Ω , k Ω , %, °C.
- 18 measurement ranges as described in paragraph 2.3.
- Selection of the measurement current:
 - OM 21: from 100 μ A to 10 A supplied by an internal self-recharging Ni-Cd battery (2.6 V, 1.8 Ah).
 - OM 23: from 10 μ A to 1 A.
- Automatic or manual range selection according to measurement voltage (fixed current).
- Three operating modes:
 - . direct current (except with 10 A range),
 - . pulsed current,
 - . alternate current (current flow inversion).
- Relative mode value read-out (ΔR or $\Delta R/R$).
- Programming directly by metal type or by temperature coefficient offers the following advantages:
 - . automatic heat measurement of the component under test;
 - . automatic compensation of its temperature, either by program or by measurement using a platinum probe.
- The RS 232-D or IEEE-488 interfaces allow programming, measurement processing and unit calibration from a computer as well as measurement output to a printer.
- Measurement storage on request (1 000 values max.) with min., max. and average values displayed or sent to the interfaces.
- Power requirements:
 - 230 V \pm 10 %, 50-400 Hz (240 V + 6 %, - 10 % permissible).
 - 115 V \pm 10 %, 50-400 Hz by internal switch.
 - Consumption: 20 VA max.
 - Optional battery pack and charger for OM 21.
- Dimensions: 225 mm x 88 mm x 310 mm (overall width: 275 mm with handle/support).
- Weight: 2 kg (3 kg max. with battery and optional IEEE-488).

2.3 MEASUREMENT SPECIFICATIONS

2.3.1 Conventions

Stated accuracies are expressed in $\pm (n \% \text{ rdg} + C)$ with rdg = reading and C = constant expressed, either as a practical unit, or a number of Representation Units (RU), i.e. the number of units of the last digit.

They apply to instruments in the reference conditions defined elsewhere after warming up for one hour.

2.3.2 Ranges

2.3.2.1 Internal current

OM 21

Range	Reso- lution	Rated voltage drop					
		Measurement current					
		10 A	1 A	100 mA	10 mA	1 mA	100 μ A
2,0 m Ω	0,1 $\mu\Omega$	20 mV					
20 m Ω	1 $\mu\Omega$	200 mV	20 mV				
200 m Ω	10 $\mu\Omega$	2 V	200 mV	20 mV			
2,0 Ω	100 $\mu\Omega$		2 V	200 mV	20 mV		
20 Ω	1 m Ω			2 V	200 mV	20 mV	
200 Ω	10 m Ω				2 V	200 mV	20 mV
2,0 k Ω	100 m Ω					2 V	200 mV
20 k Ω	1 Ω						2 V

OM 23

Range	Reso- lution	Rated voltage drop					
		Measurement current					
		1 A	100 mA	10 mA	1 mA	100 μ A	10 μ A
20 m Ω	1 $\mu\Omega$	20 mV					
200 m Ω	10 $\mu\Omega$	200 mV	20 mV				
2,0 Ω	100 $\mu\Omega$	2 V	200 mV	20 mV			
20 Ω	1 m Ω		2 V	200 mV	20 mV		
200 Ω	10 m Ω			2 V	200 mV	20 mV	
2,0 k Ω	100 m Ω				2 V	200 mV	20 mV
20 k Ω	1 Ω					2 V	200 mV
200 k Ω	10 Ω						2 V

Max. capacity: 26 000 counts.

For the OM 21, this value depends on the accumulator charge supplying the current source, the resistance of connection wires (especially for ranges using 1 A and 10 A current) and the rated voltage drop 2 V.

Max. open circuit voltage: 3 V (can be limited to 20 mV or 50 mV at the terminals of the resistor to be measured).

2.3.2.2 External current

Rated range	Rated voltage drop	
	I * Rref = 1.0 V \pm 20 %	I * Rref = 0.1 V \pm 20 %
0.02 Rref [☞]	20 mV	
0.2 Rref	200 mV	20 mV
2 Rref	2 V	200 mV
20 Rref		2 V

[☞] Rref = value of the reference resistor.

2.3.3 Accuracy

Rated voltage drop	External	Measurement current	
		10 and 1 A	from 0.01 to 100 mA
20 mV	0.05 % + 5	0.05 % + 3	0.03 % + 3
200 mV	0.05 % + 3	0.05 % + 2	0.03 % + 2
2.0 V	0.05 % + 1	0.05 % + 1	0.03 % + 1

Temperature coefficient: < 10 % of accuracy/ $^{\circ}$ C.

2.3.4 Additional specifications

- Protection: a fast electronic circuit protects against current break in an inductive resistor.

- Min. interval between measurement:
 . 500 ms in direct current mode,
 . 2 s in pulse current mode,
 . 3 s in alternate current mode.

- Manual or automatic measurement rate programmable from two measurements per second to one per 32 400 seconds (9 hours).

- Autoranging (fixed current):
 . by increasing values: > 21 000 RU,
 . by decreasing values: < 2 000 RU.

- Relative measurements
 The unit displays:
 . either $L = R - R0$ (ΔR key),
 . or $L = 100 (R - R0) / R0$ in % ($\Delta R/R$ key),

where:

L = value read,
 R = value measured in the range selected,
 R0 = reference value which is either a value stored by pressing ΔR or $\Delta R/R$ key, or a programmed fixed value.

- Automatic component temperature compensation:
 . from - 20 $^{\circ}$ C to + 130 $^{\circ}$ C, programmed by keypad or via the interfaces,
 . relative to a platinum probe (100 Ω at 0 $^{\circ}$ C) available as an option.
 Accuracy: \pm 0.5 $^{\circ}$ C.

- Analog output:
 . 0 to 2.55 V on load > 2.5 k Ω ,
 . resolution 10 mV (256 counts),
 . keypad or interface programming of values displayed for 0 V and 2.50 V,
 . accuracy: \pm 10 mV,
 . response time: according to measurement.

NOTE: values stored in the measurement memory can be converted into analog signals for plotter output.

- Double digital comparator providing two relay alarm outputs (one NO contact, 1 A, 125 V~, 30 W, 60 VA max.) programmed by limits, direction and hysteresis.

- Current source autonomy (OM 21):
 10 A pulse current, min. interval: 2 h.
 1 A direct current: 2 h

2.3.5 Other specifications

2.3.5.1 Trigger command

Triggering measurement burst remotely (§ 5.6.4) can be done by short-circuiting two terminals at back of the unit and using an external uncharged contact (dry contact or semiconductor: 5 V, 0.1 mA).

2.3.5.2 Battery operation (OM 21)

The instrument can work from the 12 V lead battery pack supplied with internal charger.

Autonomy: 2 h to 8 h depending on mode and current value selected.

Charging time: 14 hours for a fully discharged battery with unit switched off. Using the unit under charge increases this time.

When the remaining charge reaches approximately 20 %, the **BAT** message advises the user to recharge the battery.

To avoid any damage, an electronic device provides automatic disconnection of the battery in case of prolonged discharge. In this case, the unit stops operating and an immediate recharge is necessary.

2.3.5.3 RS 232-D INTERFACE

Available at rear of the unit on a 9-pin SUB-D female connector. A keypad command returns the unit to LOCAL mode.

Interface specifications

- Transmission rate: 300, 600, 1 200, 2 400, 4 800, 9 600, 19 200 bauds.
- Character format: 7 or 8 bits with 1 or 2 stop bits.
- Parity: even, odd, ignore or no parity.
- Protocol: no protocol, XON/XOFF, CTS/DTR or printer.
- In printer mode, selection of the column numbers for table display (11 characters per measurement, two spaces between successive measurements).

These parameters are programmed on the keypad and stored in battery backed memory.

Refer to chapter 7 for full details.

2.3.5.4 IEEE-488.2 interface

Available on a standard 24-pin plug.

The address of the unit is entered on the keypad and stored in battery backed memory.

A keypad command returns the unit to LOCAL mode.

Both IEEE and RS 232 circuits are set to the same potential as the trigger command.

Available functions:

AH1 SH1 T6 L4 SR1 RL1 PP0 DC1 DT0 C0 E2

Refer to chapter 7 for full details.

3. Measurement accessories

3.1 DELIVERED WITH THE UNIT

- A power supply cord.
- An instruction manual.

3.2 OPTIONAL ACCESSORIES

AN 5806-B	A pair of security measurement leads, each with a Kelvin clip, 1.20 m of wire and two 4 mm plugs.
AMT 004	One measurement lead, 3 m long, with a large Kelvin clip.
AMT 003	One measurement lead, 3 m long, with a dual Kelvin test probe.
AN 5825	Set of 10 spare fuses (5 x 20, T 160 mA/250 V).
AN 8009 (OM 21)	Set of 10 spare fuses (6.3 x 32, F 16 A/250 V).
AN 5826 (OM 23)	Set of 10 spare fuses (6.3 x 32, F 2 A/380 V).
ER 42062-001	Protection network for alarm relay contacts.
ER 48289-009	9-pin male SUB-D connector for the RS plug.
AN 5874	RS 232-D cable, 2 m long, for connection to a microcomputer (PC-XT, PC-AT or compatible) equipped with 25-pin male SUB-D connector.
AN 5875	RS 232-D cable, 2 m long, for connection to a microcomputer (PC-XT, PC-AT or compatible) equipped with 9-pin male SUB-D connector.
AN 5876	RS 232-D cable, 2 m long, for connection to a printer equipped with 25-pin female SUB-D connector.
AN 5893	RS 232-D cable, 5 m long, for connection to a printer equipped with 25-pin female SUB-D connector.
AN 5836	IEEE-488 cable, 2 m long.
LM 105	Software for programming and processing measurements on microcomputer (PC-XT, PC-AT or compatible) via the RS 232-D interface.
Platinum probes	Many models available depending on usage: please contact us.
AN 5883	Brackets for panel mounting.
AN 5884	3 U panel and brackets for rack mounting.
AMT 002-000	3 V, 10 A bench supply to replace the current source accumulators.
AN 6901	Carrying case.

4. Instructions before use

4.1 UNPACKING

The unit is mechanically and electrically checked before dispatch. Every precaution is taken to ensure that it reaches the user undamaged.

Nevertheless, it is advisable to carry out a quick check for any damage that may have occurred in transit. If any such damage is found it should be reported to the shipper.

4.2 RETURN

If the unit is to be returned, a return authorization number should be requested from AOIP factory. The original packaging should be used and a note explaining as clearly as possible the reasons for returning it should be included.

4.3 INSTRUCTIONS BEFORE SWITCHING ON

Before using the unit with all the necessary safety, the user must read **carefully** chapter 5 which deals with safety provisions.

4.4 CONTROLS

4.4.1 Front panel (OM 21)

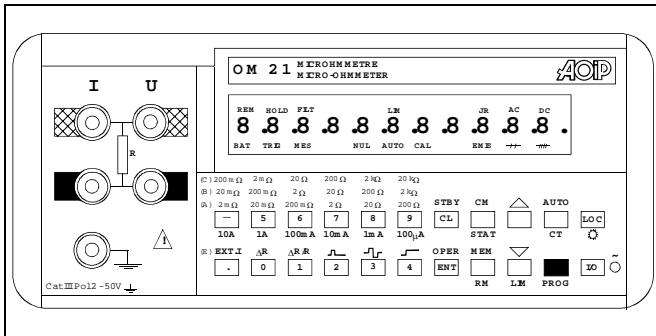

Liquid crystal display

- 11 characters, 11.5 mm high, indicating value, unit, range and operating mode.
- To the left, one function symbol **REM** (remote), one battery state **BAT**, and three measurement operating symbols **TRIG**, **MES**, **HOLD**.
- In the middle, the autorange symbol **AUTO**, the symbol **NUL** when measuring ΔR or $\Delta R/R$ and one **LIM** symbol indicating if 20 mV or 50 mV limit is in use.
- To the right, the **-//-** symbol indicating that temperature compensation is in use (measurement reduced to 20°C) and the **-///-** symbol when running the heating measurement cycle of a component.

Terminals

Five terminals for 4 mm plugs:

- 2 terminals **I** supplying the preselected measurement current.
- 2 terminals **U** to input the voltage from the resistor terminals.
- 1 ground terminal internally connected to the ground wire of the power cord.

Keypad

22-key keypad and one power indicator.

➡ Black Keys or those with a black legend

Keys selecting current

- Seven keys select measurement current:
- 6 for internal sources from 100 μA to 10 A (OM 21) and from 10 μA to 1 A (OM 23).
- 1 for external source (EXT.I).

Keys selecting operating mode

 Pulse current mode.

 Alternate current mode.

 Direct current mode.

- ΔR Relative measurement with $L = (R - R_0)$.
- $\Delta R/R$ Relative measurement with $L = (R - R_0)/R_0$.
- STBY** Standby.
- OPER** Operation. Starts a measurement cycle.
- MEM** Toggles measurement memory on/off.
- CM** Clears the last measurement in memory.
- AUTO** Toggles autoranging on/off.
- LOC** Returns to local mode.
- I/O** Switches the unit on or off.

Increment and decrement keys

These keys are marked with two triangles on the instrument and represented by two arrows (\downarrow and \uparrow) in this document. They allow manual ranging and moving through the different programming menus.

Numerical keys

- 0 to 9** Input a number.
- <->** and **<,>** Sign (sign + implied) and decimal point.
- ENT** Confirms a number, prompt or program.
- CL** Clears a number. Stops an automatic program.

➡ Blue keys or those with a blue legend

 The blue key provides access to all blue functions (including PROGramming).

- PROG** Programming access.
- LIM** Toggles the analog limit (clamping) on/off.
- RM** Displays contents of measurement bursts stored in memory.
- STAT** Displays statistics (min., max., average) on the last burst stored.
- CT** Toggles temperature compensation or heating measurement on/off.
- \star Switches display lighting ON or OFF.

4.4.2 Rear panel (OM 21)

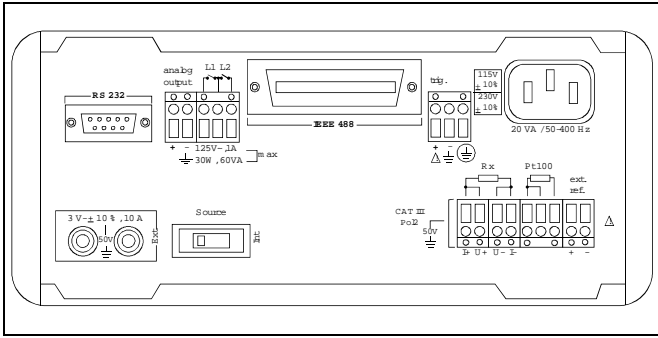

From left to right:

- 9-pin female RS 232 connector (see § 4.6.8),
- 4 mm sockets for the 3 V ± 10 % source input (OM 21 only, see § 4.6.9).
- the internal/external source switch (OM 21 only, see § 4.6.9).
- terminal board to connect the analog output and alarm outputs (see § 4.6.6 and 4.6.7),
- optional 24-pin IEEE-488 connector (see chapter 7),
- trigger command (see § 4.6.4),
-  terminal for connection to a safety conductor when the unit is battery operated (see § 4.6.5),
- plug for power cord,
- terminal block: 4 terminals are used to connect the resistor to be measured, 3 for the platinum probe (temperature compensation) and 2 for the reference voltage when using external I connection (see § 4.6.1 to 4.6.3).

4.4.3 Tilt handle position

To change the position of the handle:

- press the two yellow knobs and turn the handle,
- release the knobs and turn the handle until it locks into position. The angle between each position is 30°.

4.5 PANEL OR RACK MOUNTING

Panel or rack mounting is done with right-angle brackets in the AN 5883 optional kit. The accessory AN 5884 is used for the 3 U rack mounting and also includes these right-angle brackets.

4.5.1 Panel cut-out

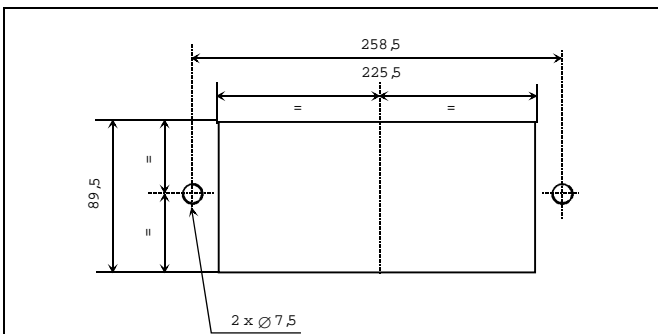

4.5.2 Panel mounting

- Remove the handle by unscrewing four screws.
- Use the four holes to fix two right-angle brackets with 4 countersunk-head screws.
- Insert unit through the panel cut-out and secure it by using two M6 screws.

4.6 CONNECTIONS

4.6.1 Internal current source

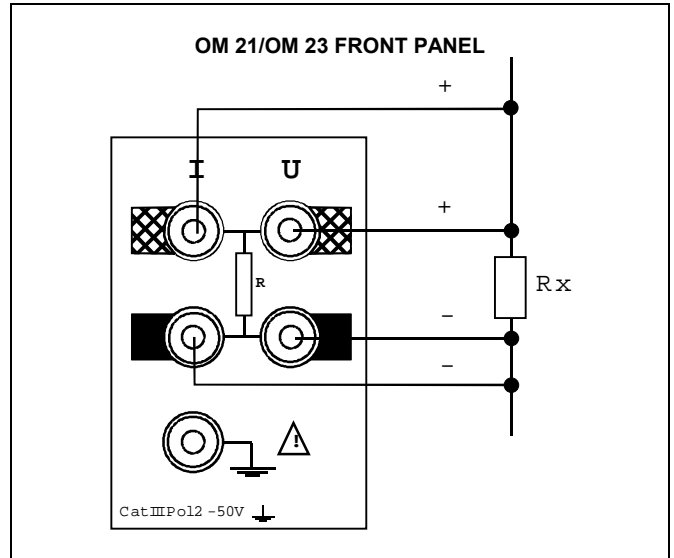

or

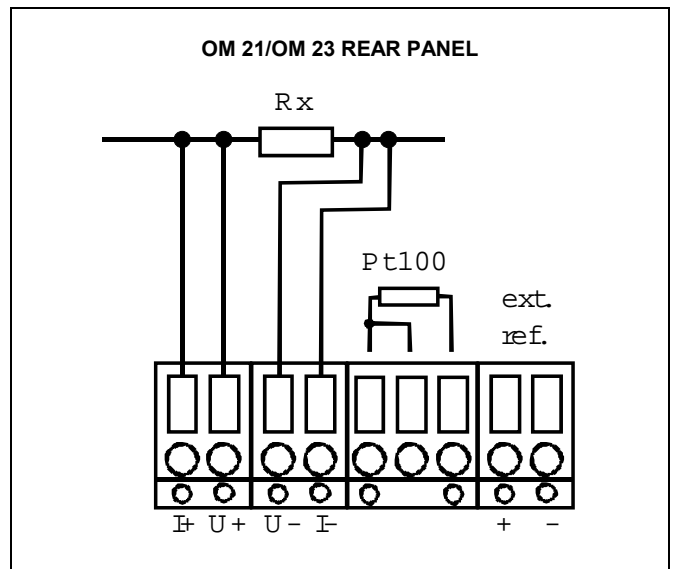

4.6.2 OM 21/OM 23 external current source

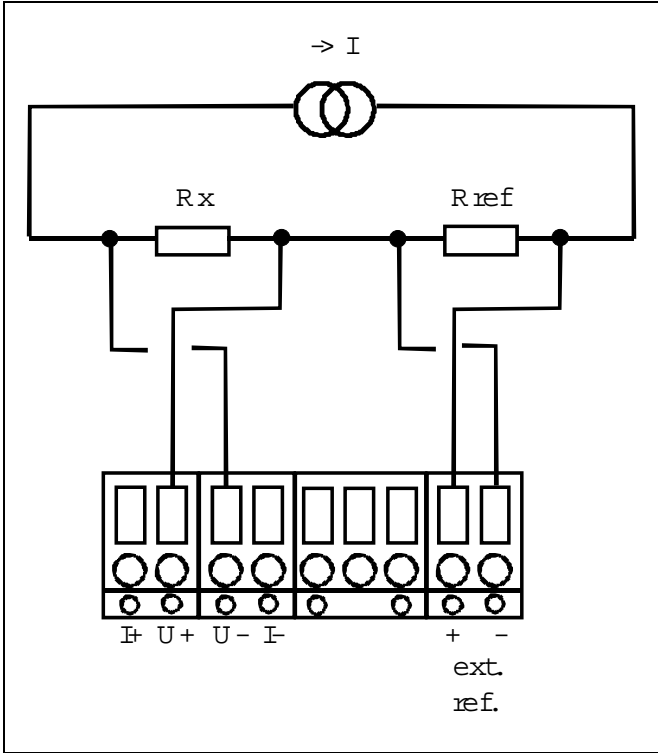

4.6.3 Temperature probe

Connect the probe to the **Pt100** terminals as indicated at back of the unit.

The "common" wire (left terminal) is set to potential of terminal **I -**.

Using 3 wires to connect the probe, make sure the resistance is balanced: 50 Ω max. permissible.

4.6.4 Trigger command

Connect the **trig.** terminals at rear to an external uncharged NO contact: dry contact or semiconductor.

If using a semiconductor, follow the polarities indicated (internal source 5 V, 47 kΩ).

The \perp negative terminal is connected to the protection earth.

4.6.5 Safety terminal

This \perp terminal near the trigger command is internally connected to the front ground terminal and to the ground wire of the power cord.

It can be used when the unit is panel-mounted and operates from the rear terminals and/or when the unit is battery-operated, without power cord, and needs to be connected to ground.

4.6.6 Analog output

Connect the **analog output + -** terminals at rear to an instrument, range ≥ 2.5 V (voltmeter, recorder, etc...).

The \perp negative terminal is connected to the protection earth.

4.6.7 Alarm outputs

Connect the **L1 L2** terminals at back as indicated. These terminals are free from any potential.

For inductive loads, it is advisable to set protection networks to their terminals by using the ER 42062-001 optional accessory (see § 3.2).

4.6.8 RS 232 Plug

Use a 9-pin male SUB-D connector (ER 48289-009 optional accessory) or one of the following optional cables:

AN 5874 for computer equipped with a 25-pin male SUB-D connector.

AN 5875 for computer equipped with a 9-pin male SUB-D connector.

AN 5876 for printer equipped with a 25-pin female SUB-D connector.

Connections are as follows:

OM side male connector 9 pins	Link	Computer side female connector		Printer male connector 25 pins
		25 pins AN 5874	9 pins AN 5875	
CD 1	→	8	1	
RD 2	→	3	2	3
TD 3	←	2	3	2
DTR 4	←	20	4	20
Com 5	—	7	5	7
DSR 6	→	6	6	
RTS 7	←	4	7	
CTS 8	→	5	8	5
RI 9	→	22	9	

NOTE:

- Remember that the RS 232 circuits are set to the potential of the trigger command, IEEE circuits and analog output.
- Upon receiving the unit, pin 5 (Common) is connected to the ground.
- Pins 1, 7 and 9 are free from any potential on OM side.
- Line DSR is permanently set to 1 (+ 9 V).
- **Always wire the wires at printer level as a minimum.**

4.6.9 3 V, 10 A external source for OM 21

On versions OM 21-1 and OM 21-3 with power supply and in case currents 1 A and 10 A are frequently used, it may be advisable, to avoid any autonomy problems dues to current source accumulators, to replace them by a 3 V \pm 10 %, 10 A external supply (AOIP part number: AMT 002-000).

For that, connect the supply outputs at the unit 3 V input using 4 mm leads and **follow polarities**, then toggle the unit to this operation mode (see maintenance, § 8.6).

5. OPERATION

5.1 SAFETY INSTRUCTIONS

5.1.1 Safety standards compliance

The unit is constructed and tested according to European Norm EN 61010-1: Safety Rules for Electronic Measurement instruments.

This instruction manual contains information and advice users must follow to protect against electrical shock and to ensure reliability, maintaining the instrument in a satisfactory state of safety.

The unit may occasionally be exposed to temperatures between - 10°C and + 50°C without safety features being compromised.

Use the power cord supplied with the unit and do connect it to a 3 pin plug including ground, meeting EEC 7 specifications.

5.1.2 Following instructions supplied with the accompanying documents

The unit is constructed to operate under safety conditions if the instructions supplied in the accompanying documents are followed. Any usage, except those described, may reduce the safety of the operator and then, becomes dangerous and prohibited.

5.1.3 Making measurements

Never connect the unit to a live circuit.

When measuring resistances with a high inductive component (transformers, motors, etc..) **do press the STBY key to cut off current.** The unit then discharges this inductance and displays the **WAIT** message.

Wires should be disconnected only when the message has disappeared and an audible warning (beep) has been heard.

5.1.4 Faults and abnormal forces

If there is any indication that instrument safety has been compromised, it should be taken out of service and steps taken to prevent it being used inadvertently.

Safety may be compromised in any of the following cases:

- the instrument is visibly damaged,
- the instrument is no longer capable of making accurate measurements,
- the instrument has been stored in unfavorable conditions,
- the instrument has been subject to severe stresses or shock during shipment.

5.1.5 Definitions

5.1.5.1 Definition of the installation category

This is also called overvoltage category.

It's the installation classification according to standardized limits for transient overvoltages (IEC Publication 664). Level of these limits depends on the nominal line voltage, regarding the earth, which is present in the unit environment.

The Publication has 4 levels of increasing overvoltage, from CAT I to CAT IV.

5.1.5.2 Table of the symbols used

Symbol	Description
~	Alternating current.
⋮	Direct current.
≈	Direct and alternating current.
⊥	Measurement earth terminal.
⊕	Protective conductor terminal.
I	Power ON.
O	Power OFF.
□	Double insulation.
⚠	Risk of electric shock.
⚠	Warning: see the accompanying documents.

5.1.6 Maintenance

The unit should be reassembled as explained in the instruction manual. Any incomplete or bad reassemble may be dangerous for the safety of the operator.

The responsible body must check at regular time interval that all the components ensuring safety are not subject to wear and undertake all the necessary steps for preventive operations.

Refer to chapter 8.

Before opening the case, make sure the instrument is disconnected from any dangerous voltage source and that no output signal is being generated.

Replacement fuses must be of the same type and rating (see § 8.3).

The instrument should not be opened for adjustment, maintenance or repair when live unless absolutely essential, in which case the work should be carried out **only by appropriately qualified personnel.**

5.2 SWITCHING ON

Make sure that the power voltage matches that indicated on the rear panel.

Connect the power cord. The indicator "~" comes on confirming power to the instrument.

NOTE: Models with optional battery pack only require connection to the power supply when the BAT symbol appears at the left of the display, indicating that the battery should be recharged. The unit can be used during charge, but charging time will be increased.

Press I/O: the unit is powered up, performs an initialization and self-check procedure for a few seconds, then switches to standby with the following configuration:

- saving configuration not in use:
 - . 100 μ A current,
 - . 200 Ω range,
 - . direct current mode,
 - . autorange.
- saving configuration in use: current range and modes preceding the last switching off.

 **The unit is ready to be used after switching on for 30 seconds.**

To check software version, press:

 **PROG PROG ENT**

(Throughout this manual,  signifies the blue function key)

The instrument serial number appears for a few seconds followed by the software version, which should correspond to that mentioned on page 1 of this document.

5.3 ERROR MESSAGES

During operation, most errors are displayed with an audible warning (beep).

5.3.1 Display

OVERLOAD	Abnormal voltage on input circuits.
OVERRANGE	Measurement exceeds max. value over range selected (manual range) or over highest range for a given current (autorange).
CURRENT < 1A	Select a measurement current below 1 A and wait for a sufficient recharging of the accumulators powering the current source (LO BAT symbol blinks during this recharge).
(U) OPEN	Signals one wire broken in voltage connections after pressing OPER key when the unit was previously in standby.
(I) OPEN	Signals either opening of or too high resistance in current circuit when the unit is operating in pulse or alternate current mode.
CONNECT. ERR	Indicates an incorrect connection, such as inversion of voltage wires compared to current wires.
CLAMPING	If one or both 20 mV or 50 mV analog limits are in use, indicates that voltage drop at terminals of the resistor to be measured is higher than this limit.
HIGH E.M.F	Indicates a too high offset voltage when measurement is made for automatic correction of external stray E.M.F.
PROBE ?	Indicates absence or incorrect connection of the temperature probe.

These messages are accompanied by a beep.

5.3.2 Audible warning (beep)

A beep is emitted each time:

- a procedure needs consecutive entries on several keys (input of a numerical value for example) if entry stops for more than four seconds,
- an operation cannot be taken into account.

In both cases, the unit returns to initial state.



5.4 USING THE SECONDARY FUNCTION KEY

The blue key  accesses the following functions:

- setting or removing voltage limits (§ 5.7.3),
- setting or removing temperature compensation (§ 5.7.5) or heating measurements (§ 5.7.6),
- displaying statistics (min., max., average) on the last burst stored (§ 5.8.2),
- displaying the bursts stored in memory (§ 5.8.3),
- programming functions: see chapter 6,
- lighting the display (see below).

On pressing  key, if no function is entered within four seconds, the unit returns to the previous state and emits an audible warning (§ 5.3.2).

USING KEY TO LIGHT THE DISPLAY

- Press  then  key to switch light on.
- Repeat to switch off.

5.5 SELECTING OPERATING MODES

5.5.1 4-wires principle

See diagram below.

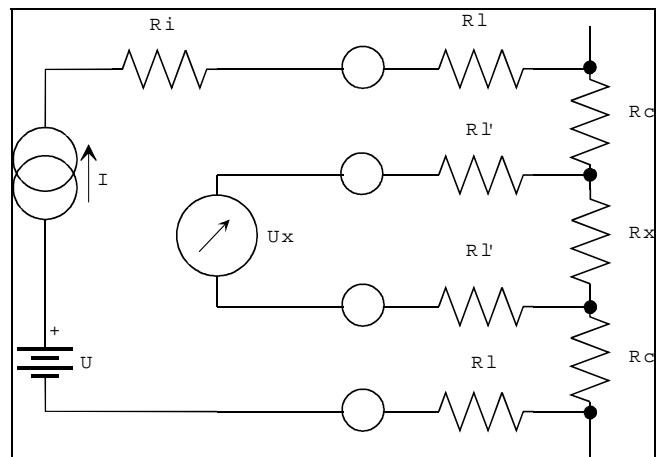

From a voltage source U, a generator supplies a current of value I and determined waveform (pulse, alternate or direct)

A voltmeter measures the voltage drop U_x at the terminals of the resistor to be measured R_x and displays $R_x = U_x / I$.

The result is not affected by other resistors encountered in the current loop (R_x , R_l , R_c), as long as the total voltage drop induced across R_x remains below the voltage supplied by the source U.

For Rx defined by the range set, Ux squares with the measurement rated voltage for the measurement range selected.

To measure a resistance whose approximate value is known, the range table in § 2.3.2 shows that the measurement can generally be performed with three different values of measurement current and rated voltage.

5.5.2 Selecting measurement current

To select (or change) current:

- Press **10 µA** (OM 23) **100 µA**, **1 mA**, **10 mA**, **100 mA**, **1 A**, **10 A**, (OM 21) or **EXT.I**

The unit then displays the new range which is function of the previous rated voltage and does not change.

In external current mode, the range also depends on the programmed values specific to this operating mode (§ 6.4.14).

NOTE: Changing current automatically returns the unit to standby.

5.5.3 Selecting rated voltage

For a previously set measurement current, the unit offers three measurement voltages A, B and C indicated at the extreme left of the display as well as on the keypad legend (between brackets in front of the ranges).

- **(A)**: 20 mV rated voltage.
- **(B)**: 200 mV rated voltage.
- **(C)**: 2 V rated voltage.

To change measurement voltage:

- either use autoranging by pressing **AUTO**: the same symbol lights on the display bottom line,
- or use manual ranging by pressing \uparrow and \downarrow keys: the **AUTO** symbol disappears.

NOTE: Changing ranges does not change measurement current, so they are limited to three.

5.5.4 Selecting current waveform

Three current waveforms are available by pressing the following keys:

 Pulse current.

 Alternate current.

 Direct current.

NOTE: Changing waveform automatically returns the unit to standby; current and range are not affected.

5.5.4.1 Pulse current

This is the current mode generally used to measure **low inductive** resistances accurately (time constant below 1 ms).

Each measurement is performed as follows:

- switch current off, measure residual voltage (U0) at resistor terminals: if more than the measurement rated voltage, **HIGH E.M.F** error is displayed;
- switch current on for 200 ms, compare to selected current: if wrong **(I) OPEN** error is displayed;

- measure voltage at resistor terminals (U1) and break current,
- display measurement ($L = (U1 - U0) / I$) or error: **OVERRANGE**, **CONNECT. ERR**, **CLAMPING** etc...

Measurement duration: between 0.5 and 0.8 s depending on measured resistance value.

5.5.4.2 Alternate current

This is the current mode recommended for measuring ground continuity or contact resistance and by storing, according to standards, the highest or average value in both current directions. As stated above, this mode only applies to low inductive resistors.

Each measurement is performed as follows:

- switch current off, measure residual voltage (U0) at resistor terminals: If more than the measurement rated voltage, display **HIGH E.M.F** error message,
- switch current on respecting terminal polarity for 200 ms, compare to selected current, if wrong, display **(I) OPEN** error message,
- measure voltage across resistor terminals (U1) and break current,
- switch current on inverting terminal polarity for 200 ms,
- measure voltage across resistor terminals (U2) and break current,
- compute both measurements: $L1 = (U1 - U0) / I$ and $L2 = (U0 - U2) / I$,
- if there is no operating error and depending on selected program (§ 6.4.13), display average value $L = (L1 + L2) / 2$, or max. value L1 or L2.

Measurement duration: between 0.8 and 1.4 s depending on measured resistance value.

5.5.4.3 Direct current

Because of the limited power of the internal current source, only currents below 10 A can be measured.

This mode is designed to measure resistances featuring a high inductive component: transformers, motors, etc...

Remember that the charge (or discharge) time constant of an inductor S (in Henrys) loaded by a current I (in Amperes) under a voltage U (in Volts) is t (in second) = $S I / U$.

With an OM and to simplify, take $U = 2$ V for charge and $U = 1$ V for discharge. This gives:

$$t_c = S I / 2.$$

$$t_d = S I.$$

In this case it is impossible to switch current on and off each time a measurement is performed.

From standby, a measurement cycle (§ 5.6) starts as follows:

- switch current off, measure residual voltage (U0) across resistor terminals. **This value is displayed for a moment (in mV) and stored in the burst memory if activated.** If more than the measurement rated voltage, there is display of **HIGH E.M.F**,

- **switch current on and maintain as long as the unit does not return to standby**, either by pressing **STBY** key or by selecting another measurement current or current mode,

- the user may program the time-delay authorizing the first measurement after the Time of Charge (TOC) has elapsed.

- at the end of the Time Of Charge (TOC) programmed, if the current is not completely switched on, the measurement, while incorrect, is displayed to follow evolution, **but an (*) symbol adds to the unit indicating that it is not stored nor taken into account by any other active functions.**

- measure voltage across resistor terminals (U1) and display $L = (U1 - U0) / I$,

- any following measurements display U1, U0 being stored in memory. So, in this current mode, it is advisable to work on a fixed range to perform the offset measurement with the same rated voltage as the main measurement, or from the lower range (letter A displayed) if autoranging is selected.

- **for safety reasons, returning to standby via one of the commands indicated above, implies waiting for complete discharge. During this period, the OM displays WAIT and all hands should be kept away from connecting wires.**

Measurement duration: between 0.2 and 0.4 s depending on measured resistance value.

5.5.4.4 External current (EXT.I)

Connection is as indicated in § 4.6.2.

Because the OM cannot "control" this current, it automatically switches to direct current mode when **EXT.I** key is pressed.

As the current cannot be switched off because the reference voltage would be lost, the following method is used to compensate for any offset voltage:

- connect as indicated in § 4.6.2,

- open the external current circuit,

- **perform a measurement using any internal current in direct current mode and, if possible, use the intended voltage range or the 20 mV range (letter A),**

- switch to external current mode,

- close external current circuit,

- start measurement cycle.

The value of external current I can be selected between 10 mA and a few hundred amperes, but the voltage drop ($V_{ref} = I * R_{ref}$) across terminals of the reference resistor must be chosen between 100 mV \pm 20 % and 1 V \pm 20 % (refer to § 6.4.14 to program the EXT.I mode).

Using manual or automatic ranging, three measurement ranges are available:

- for $V_{ref} = 1$ V: (A) 0.02 R_{ref} , (B) 0.2 R_{ref} , (C) 2 R_{ref} ,

- for $V_{ref} = 100$ mV: (A) 0.2 R_{ref} , (B) 2 R_{ref} , (C) 20 R_{ref} .

5.6 MEASUREMENT CYCLE

5.6.1 Standby position

The unit is set to standby:

- at switch on,

- by pressing **STBY**,

- by pressing one of the keys which change measurement current or waveform,

- after temperature corrected measurements with a probe,

- after heating measurements.

This position:

- switches off internal current source,

- short-circuits current terminals (I),

- waits for a change in operating characteristics, starting a measurement cycle either by pressing **OPER** key or the external trigger command, or the RS 232 link or IEEE bus.

5.6.2 OPER command

This command triggers a measurement cycle depending on the following parameters:

- number of measurements **Nb** programmable between 0 (permanent measurement) and 65 535,

- delay **DEL** between command and first measurement (measuring the offset voltage in all current waveforms) programmable between 0 s and 32 400 s (9 hours),

- in **direct current** mode, the Time Of Charge (**TOC**) between current switching on and the first measurement,

- interval **INT** between two consecutive measurements, programmable between 0.5 s and 32 400 s.

To program these parameters, refer to § 6.4.17.

In view of the typical duration of a measurement cycle in pulse or alternate mode (§ 5.5), an interval of 0.5 second is not realistic and the unit defaults to a rate compatible with each operating mode.

Programming 0 s for the **DEL**ay increases it by 0.5 s when starting cycle from the "standby" position, while from the "hold" position it remains to 0.

5.6.3 HOLD position

Once the last measurement has been completed, the unit remains in a hold position which is different from the standby position in direct current mode in that measurement current remains present at the output "I".

In **direct current mode**, a new **OPER** command triggers another measurement cycle **without offset**.

So, in direct current mode, to measure the offset voltage again (e.g. after changing range) it is first necessary to switch to standby position.

5.6.4 External trigger command

Same function as the **OPER** key.

This command operates each time the **trig.** terminals at back of the unit are short-circuited (see § 4.4.2 and 4.6.4).

5.6.5 Operating diagrams

Below, are the operating diagrams of the three current modes from standby position and **Nb** = 3 measurements.

pulse current

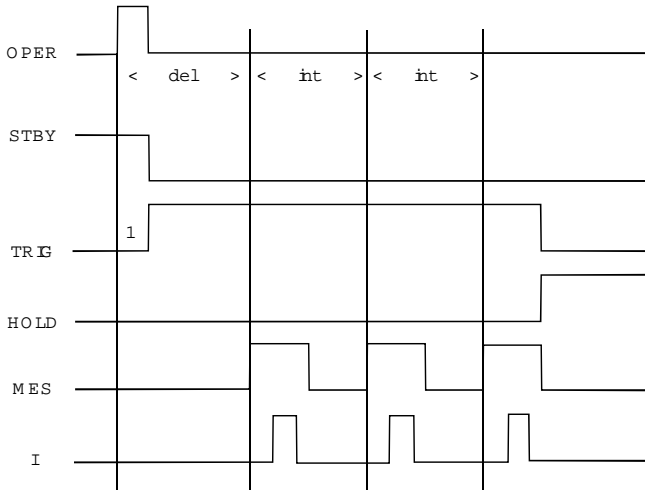

1: testing voltage wires (**U**) and first ambient temperature measurement if requested.

alternate current

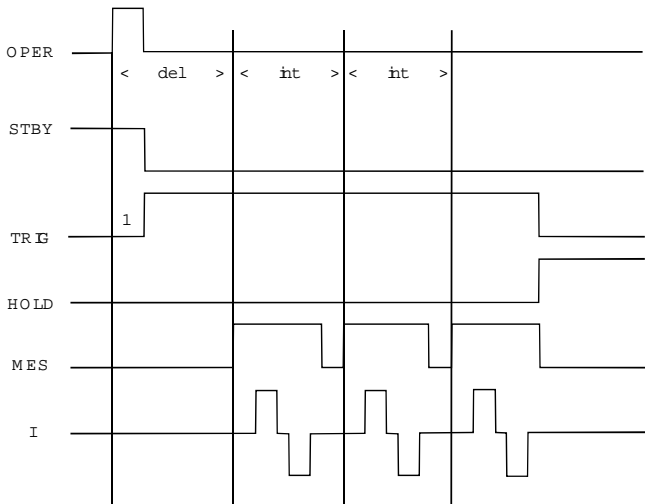

1: testing voltage wires (**U**) and first ambient temperature measurement if requested.

direct current

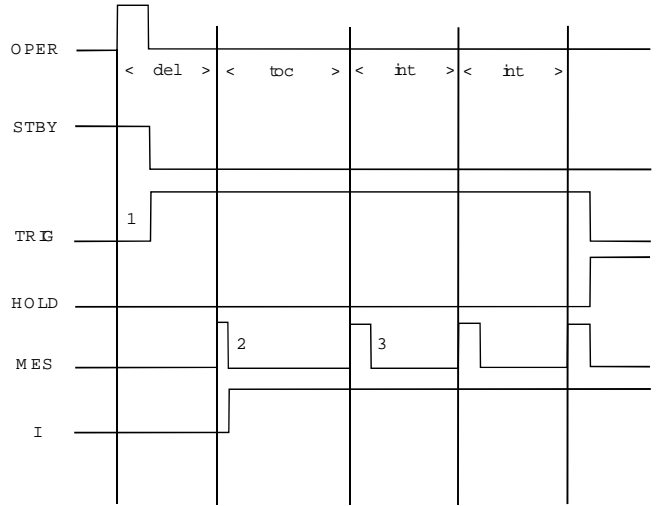

1: testing voltage wires (**U**) and first ambient temperature measurement if requested.

2: measuring offset voltage (stored).

3: first measurement.

5.7 OTHER FUNCTIONS

5.7.1 Relative measurement (ΔR)

By means of the ΔR key, with display of **NUL** symbol.

The displayed value (L) is then the algebraic difference between the real value (R) and an ohmic value stored in permanent memory (R0): $L = (R - R0)$.

R0 which depends on programmed function (§ 6.4.15) can be:

- either fixed by entering value on keypad,
- or equal to the last value measured by the unit.

In the latter case, this value can be kept and not modified by any subsequent entry of the ΔR key (or $\Delta R / R$), simply by reprogramming this function by selecting **FIXED R0 ?** and validating the proposed value.

5.7.2 Relative measurement ($\Delta R / R$)

This function is activated by pressing $\Delta R / R$ key, with display of **NUL** symbol.

The principle is the same as for the ΔR function and the R0 value is obtained in the same way, except that the display reads:

$$L = (R - R0) / R0.$$

WARNING.: to get directly from ΔR to $\Delta R / R$ from a **measured** value R0, do not forget to fix the value with the **FIXED R0 ?** function as described in the previous paragraph.

5.7.3 Analog limits (clamping)

To avoid damaging an insulation layer (by oxidation for example) between two contacts by applying voltages higher than a few hundred millivolts, contact resistance standards advise clamping to 20 mV or to 50 mV relative to the voltage at the terminals of the component under test.

Activating or deactivating this limit is done by pressing  and **LIM**, which is accompanied by the appearance or disappearance of the **LIM** symbol on the display.

The choice between the 20 mV and 50 mV ranges is done by programming **CLAMPING ?** (§ 6.4.18).

5.7.4 Alarms

The unit has two alarm outputs whose limits (L1 and L2) have their value, hysteresis and direction programmable (§ 6.4.1).

In case of malfunction, (see error message list § 5.3.1), an arbitrary measurement value (outside any possible measurement range) is attributed to each alarm level, according to the following table:

OM 21		OM 23	
OVERLOAD	90 kΩ	OVERLOAD	900 kΩ
PROBE ?	50 kΩ	PROBE ?	500 kΩ
CLAMPING	40 kΩ	CLAMPING	400 kΩ
OVERRRANGE	30 kΩ	OVERRRANGE	300 kΩ
HIGH E.M.F.	- 1 kΩ	HIGH E.M.F.	- 1 kΩ
(U) OPEN	- 2 kΩ	(U) OPEN	- 2 kΩ
(I) OPEN	- 3 kΩ	(I) OPEN	- 3 kΩ
CURRENT < 1A	- 4 kΩ	CURRENT < 1A	- 4 kΩ
CONNECT. ERR	- 5 kΩ	CONNECT. ERR	- 5 kΩ

By choosing appropriate values for L1 and L2, alarms for certain or for all these malfunctions can be activated or deactivated.

5.7.5 Temperature compensation

Metals used in the windings of certain components (for example the copper wire in transformers or motors) have high temperature coefficients, of the order of 0.4 % per degree C (copper and aluminum).

This means that the resistance measured is directly related to the temperature of the component.

Providing one knows the metal involved or its temperature coefficient, the "Temperature compensation" function displays the "Rt" value of the resistor reduced to a constant temperature of 20°C.

Activating this compensation

- Press  then **CT** keys.
- Message **TEMP. COMP. ?** appears for a few seconds.
- During this time and in case of error, pressing **CL** returns the unit to initial state.
- If not, activating this function displays **-/-** symbol.

If required and by using the "Temperature" program (§ 6.4.16) check determination mode of the ambient temperature (measured by means of a probe or entered on keypad) as well as the metal selection or its temperature coefficient.

Selecting temperature measurement, implies connection of the probe as indicated at rear of the unit and checking for a time interval between two successive temperature measurements.

Running a measurement cycle

Starts with measurement of the ambient temperature if programmed, then continues with resistance measurement compensated in temperature (Rt) and display.

When the measurement is correct (stable) changing for standby mode by pressing **STBY** key stores it into a special memory, as well as the Time of Charge needed to current switching on.

This memory can contain ten resistance values from Rt0 to Rt9 and ten time values from tc0 to tc9. The unit displays for a few seconds a memory register as **Rt x ?**:

- press **ENT** to validate this prompt (or wait end until of time-delay),
- press a number key to validate another memory register.

To quit the function

- Press  then **CT** keys.
- Message **HEATING ?** appears for a few seconds.
- During this time pressing **CL** returns the unit to uncompensated measurements.
- If not, function "Heating measurement" is activated and **-///-** symbol is displayed (see § 5.7.6).

5.7.6 Heating measurement



The objective of this measurement is to determine the amount by which the temperature of a winding (transformer, motor, etc...) has risen due, in particular, to the thermal dissipation of the resistor under stress.

The principle of this measurement is as follows:

Phase 1

With the winding cold (i.e. out of service for a sufficiently long time), the resistance "Rt" is measured and reduced to 20°C (§ 5.7.5), the time of charge is measured and both are stored in the "Rt memory". The unit can then be disconnected from the tested winding and switched off.

Phase 2

Once the winding has reached its working temperature, enter in the function by pressing  and **CT** if the "Temperature compensation" is in use, if not press  and **CT** again (the symbol **-///-** is displayed).

The unit then displays the last measurement stored in the memory register Rt.

If this one is not satisfactory, the user can step through all the memory registers with the **↑** and **↓** keys:

- if one value suits, press **ENT** key to validate it,
- if not, enter the desired Rt value by the keypad into one (or more) memory registers then press **ENT** to validate this choice.

Then, the unit indicates the current Time of Charge in the winding corresponding to the Rt value selected. If this one does not suit, enter the new value and validate by pressing **ENT** key.

The unit executes a new ambient temperature measurement (if the **TEMPERATUR.?** program is in **MEAS. TEMP.?** mode), or proposes the last recorded temperature (in **FIXED TEMP.?** mode) which can be validated or modified from the keypad.

The situation is now the following:

- the winding under test is still powered up,
- the unit is not connected to it,
- the display indicates **READY ?**.

From this moment, the user can stop the "Heating measurement" function by pressing **STBY** key.

If not, simultaneously power down the component under test and press OPER.

This starts an internal timer. The display shows **MEASURE ?**; the terminals of the unit should now be connected to the winding and press **OPER** once more to start a measurement cycle.

NOTE: This program automatically sets the measurement number Nb to 0 (permanent measurement) and the interval INT to 1 s (if INT was lower than this). However, before starting this type of measurement, check that the time delay DEL before the first measurement and the interval INT between two measurements are correctly programmed.

A value of a few seconds to some tens of seconds for DEL, allowing thermal stability to have been reached before measuring offset and an interval INT of 1 s between measurements are usually adequate.

As the first correct measurement is displayed after a time t_1 measured by the timer triggered by cutting power to the component under test (1st press on **OPER**), the unit continues measuring until time t_2 defined as: $t_2 = 5 * t_1$. This value t_1 is stored in the burst memory if the memory is activated.

Taking into account the cold state resistance of the component (R_t) and the exponential decrease of its temperature, the unit computes the resistance of the component at time $t = 0$ at power cut-off and deduces the degree of heating present at that time.

The level of heating Δt is displayed in °C and an audible warning (beep) indicates the end of the procedure and the return to "standby" position.

To carry out a similar heating measurement on another winding, reset the function as indicated above.

5.8 MEASUREMENT MEMORY

The instrument contains 1 000 memory registers, organized by burst into a maximum of 50 bursts numbered from 0 to 49.

The user can directly activate memory storage by pressing **MEM**, whereupon the last character of the display shows the letter **m**.

Pressing **MEM** a second time stops storage and removes the letter **m** from the display.

Each time the unit is set to standby, either directly by pressing **STBY**, or indirectly by changing mode (§ 5.6.1), **a new burst is created.**

At the 50th (burst n° 49), all burst numbers are decremented (the burst n° 0 disappears) and the last one created keeps the number 49.

In the same way, on the 1 000th measurement the older measurements disappear one by one.

A whole burst can be removed in this way once it no longer contains any measurements, which decrements the number of each following burst.

NOTE: changing range, manually or automatically, does not automatically create a new burst as each measurement is stored with its range.

Each burst is stored in memory with the following parameters:

- The number of measurements included.
- Time interval between measurements.
- Measuring current.
- Current waveform.
- In direct current mode:
 - . previous offset measurement (Vofs),
 - . Time of Charge (TOC).
- In external current mode, the reference resistor value (Rref),
- In relative measurement mode, the reference resistor value (R0),
- In temperature compensation or heating measurement mode, the ambient temperature and metal temperature coefficient.
- In heating measurement mode, the cold resistance value (R_t) and time t_1 between supply power down and first measurement performed.

NOTE: in all modes, except temperature compensation, raw data is stored in memory, even when displayed values are different, as in the case of ΔR , $\Delta R / R$.

However it is still possible to display processed values as all parameters are stored in the burst memory.

In "temperature compensation" mode, are stored the measurements reduced to 20°C (displayed measurements).

5.8.1 Immediate measurement clearing

When the memory is active, the last measurement, and only the last one, can be cleared immediately by pressing **CM**.

5.8.2 Statistics on the last burst

Press  then **STAT**.

- If the memory is empty, the message **MEMOR. EMPTY** is displayed for two seconds and the instrument terminates the procedure.

- If not, the maximum value of all measurements in the last burst (the current burst) is displayed.

Pressing \uparrow then \downarrow causes the display of minimum and average values followed by the question (**PRINTER ?** and **ANAL. OUT. ?**), and the maximum value once more.

To terminate this procedure, press **CL**.

If on the question **PRINTER ?**, the user presses **ENT**, the unit sends the burst contents to the printer via the RS 232 link previously configured thanks to the **INTERFACE** procedure in § 6.4.9 and validated by the **PRINTER** procedure in § 6.4.8.

The burst contents format is that of the response to the interface **OUT_BURST?** question (§ 7.3.7) but the measurements are printed in table of n columns where number n is stored in the interface procedure (§ 6.4.9).

If on the question **ANAL. OUT. ?**, the user presses **ENT**, the unit converts all burst measurements into voltages via the analog output, according to the following scaling:

- MINimum output value 0.0 V,
- MAXimum output value 2.5 V.

In both cases, press **ENT** to validate the existing value or enter a new value. For further details about programming the analog output, see § 6.4.12.

The instrument displays **READY ?** (indicating the recorder is connected and correctly set up) and on validation by pressing **ENT**, the message **IN PROGRESS** appears as the unit sends out all measurement values in the burst at the rate of one per second.

After sending the last value, a beep sounds and the instrument terminates the procedure.

5.8.3 Displaying bursts

Press  then **RM**.

- If the memory is empty, the message **MEMOR. EMPTY** is displayed for approx. two seconds and the instrument terminates the procedure.
- If not, the unit displays the measurements of the last burst stored in memory **BURST N ?**.

If this is not the burst required, skip through the other bursts from 0 to n by pressing \uparrow or \downarrow .

Once the correct burst number is displayed, the procedure offers three possibilities:

- clear the burst by pressing **CM** and validating with **ENT**,
- enter in the **STATISTICS** procedure (§ 5.8.2) of this burst, by pressing  then **STAT**.
- display by pressing **ENT** the contents of the burst: the number of measurements **Nb** together with measuring current. Pressing **ENT** again followed by \uparrow or \downarrow skips through the measurement values in the burst, starting at the oldest measurement **m 0** to the last one **m (Nb-1)**.

To clear any measurement value, press **CM** and confirm with **ENT**.

If the burst measurements have been made as relative measurements (ΔR or $\Delta R/R$), the result can be displayed by pressing ΔR or $\Delta R/R$.

NOTE: during this procedure, to go back one step or to terminate the procedure, press CL.

6. Programming

The programming function is designed to enter, store in permanent memory and read data and parameters concerning the 18 programmable procedures available in the unit.

6.1 KEYPAD PROGRAMMING FUNCTIONS

The keypad takes on the following functions during programming procedures:

0 to 9 (-) (.)	Enter numerical data.
CL	Clears a number or terminates without changing values.
ENT	Validates a numerical value. Confirms a displayed prompt.
↓ and ↑	Answers negatively to a displayed prompt and steps through to another menu prompt.

Other keys are not used, except for those giving direct access to a particular programmed procedure.

6.2 ACCESSING A FUNCTION - CHOOSING A PROCEDURE

The main menu of the 18 programmable procedures is accessed at all times in the following way:

- Press  (Blue function key)
- Press **PROG**. The message **PROGRAM ?** is displayed for a few seconds.



















Next the programmed procedure is selected and validated:

- either by stepping through all those available with the ↑ or ↓ keys according to the following table, and validating the choice by pressing **ENT**,
- or by one of the direct access keys followed by pressing **ENT**.

↑	Stepping through the menu by pressing ↑
	Direct access key
ALARMS ?	↑
RES/km	6
SAVE CONFIG	8
RESET ?	9
DEL.MEMORY?	CM
CAL. DATE ?	ENT
CALIBRATE?	2
PRINTER ?	-
INTERFACE ?	LOC
LANGUAGE ?	CL
IDENTITY ?	PROG
RETURN ?	ENT
ANAL.OUT. ?	MEM
MODE ~	3
EXTERN I ?	EXT.I
dR ? dR/R ?	ΔR or ΔR/R
TEMPERATUR?	CT
MEA.CYCLE ?	4
CLAMPING ?	LIM

↓ Stepping through the menu by pressing ↓

6.2.1 Summary of the different programming procedures

Program	Direct access and validation
Alarms Value, direction and hysteresis of Limit 1. Value, direction and hysteresis of Limit 2.	 PROG ↑ ENT
RES/km Measures the resistance per kilometer and per wire (multiwire cable).	 PROG 6 ENT
Save configuration Saves the measurement configuration.	 PROG 8 ENT
RESET Resets the memory to the default values. Erases the burst memories.	 PROG 9 ENT
Erase memory Erases burst memory.	 PROG CM ENT
Calibration date Recalls the last calibration date.	 PROG ENT ENT
Calibration See the chapter concerning maintenance (§ 8.7).	 PROG 2 ENT
Printer Activating or deactivating the printer.	 PROG - ENT
Interface Validating RS 232 or IEEE 488. Link parameters.	 PROG LOC ENT
Language Choice between French, English, German, Spanish, Italian.	 PROG CL ENT
Instrument identity Serial Number. Software version.	 PROG PROG ENT
RETURN ? is not a program key: Validating it by pressing ENT steps back to the preceding state in the programming menu.	
Analog output Value corresponding to the minimum output (MIN) 0.00 V. Value corresponding to the maximum output (MAX) 2.50 V.	 PROG MEM ENT
Alternate current mode Selects the maximum or average measurement value in both current directions.	 PROG 3 ENT
External current measurements Voltage drop at the terminals of the reference resistance. Value of this resistance.	 PROG EXT.I ENT
Relative measurements Choice between measured or fixed reference value (R0). R0 value if fixed value.	 PROG ΔR or ΔR/R ENT
Temperature programs Choice between measured and fixed temperature. Choice of metal or of its temperature coefficient.	 PROG CT ENT
Measurement cycle Number of measurements Nb. Delay before the first offset measurement DEL. Time of charge (TOC). Interval between two measurements INT.	 PROG 4 ENT
Analog limit (clamping) Either 20 mV or 50 mV.	 PROG LIM ENT

6.3 GENERAL PROGRAMMING PROCEDURE

In general, each programmed procedure works by step-through menus selected using the ↑ or ↓ keys just like the main menu (see above).

Numerical data entry may also be necessary.

The diagram of each programmed procedure described below is made up of the symbol of each key to be pressed using the following typographic conventions:

Initial state State of the instrument before entering in programming function.

prompt ? Displays a prompt to be validated or not.

dn = xxxx u Displays a numerical data stored into memory to be changed or not (u = unit).

↑

prompt 1 ?
prompt 2 ?

↓

Step-through menu in which the first prompt displayed is always the same. Stepping to another prompt is done by the ↑ or ↓ keys.

↑

prompt x ?
prompt y ?
prompt z ?

↓

Step-through menu in which the first prompt displayed is the one in memory. Stepping to another prompt is done by the ↑ or ↓ keys.

ENT Press **ENT** to confirm a prompt or validate a numerical data (whether modified or not).

Return Usually means the initial state or the state found at power-on or after calibration procedure.

NOTE: a double lined box is used to represent the value of the programmed function currently in memory.

6.4 PROGRAMMING PROCEDURES

For a key to the symbols used, see § 6.3.

6.4.1 Alarms

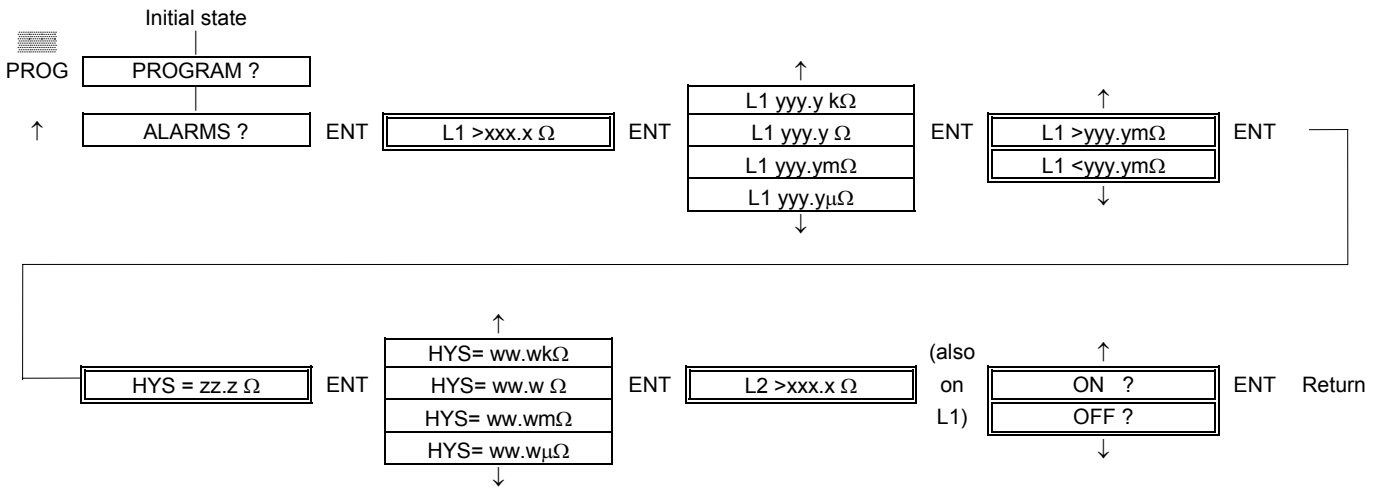

Display abbreviations

L1 >xxx.x Ω Old value to be changed if necessary using the numerical keys (see § 6.1).

L1 yyy.y kΩ
L1 yyy.y Ω
L1 yyy.ymΩ
L1 yyy.yμΩ

Once the old value is changed, choose the new unit.

As the old value has been changed, select the relay flip direction:

L1 >yyy.ymΩ > = close relay contact if values increase,
L1 <yyy.ymΩ < = close relay contact if values decrease.

ON ?
OFF ?

Activation or deactivation of **both** alarms.

6.4.2 Resistance per kilometer

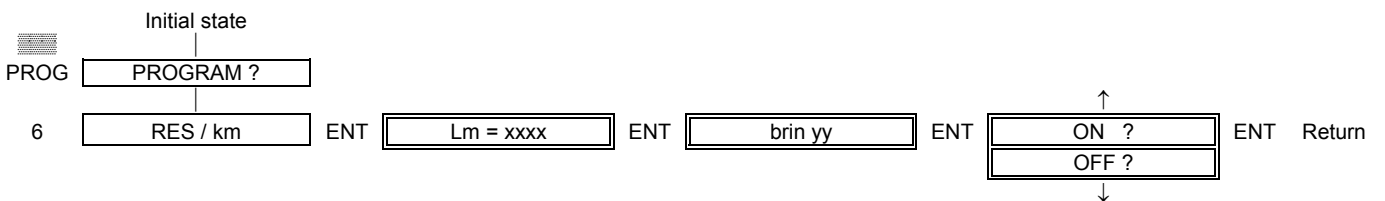

Display abbreviations

Lm = xxxx Cable length in meters. **Programming limits:** $100 \leq Lm \leq 9999$.

brin yy Number of wires in the cable. **Programming limits:** $1 \leq \text{wire} \leq 100$.

ON ?
OFF ?

Switches the function ON or OFF.

6.4.3 Saving the measurement configuration

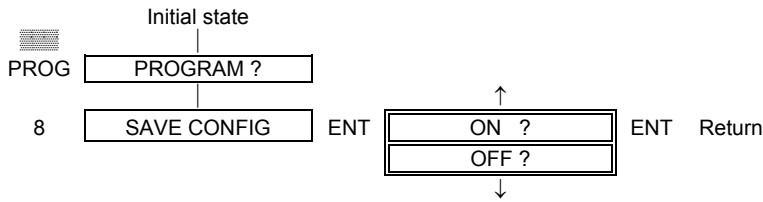

Display abbreviations

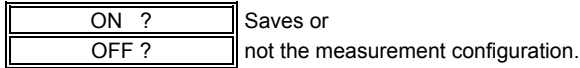

6.4.4 Resetting the protected memory

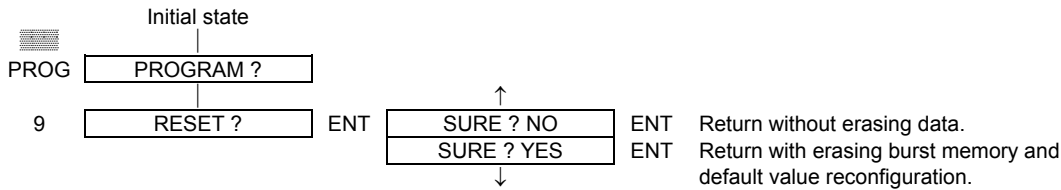

6.4.5 Erasing the burst memory

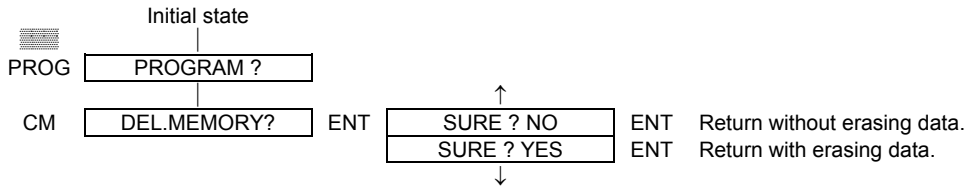

6.4.6 Calibration date

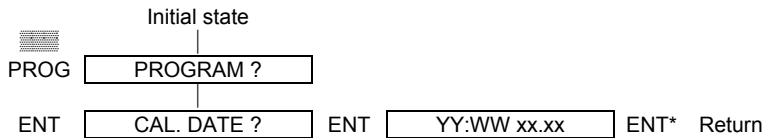

* If **ENT** is not pressed, after displaying the date for a few seconds, the unit returns to initial state.

Display abbreviation

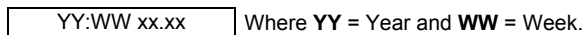

6.4.7 Calibration

See the chapter on maintenance § 8.7.

6.4.8 Printer

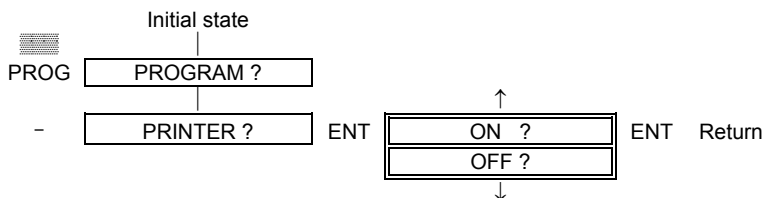

Display abbreviations



6.4.9 Interface

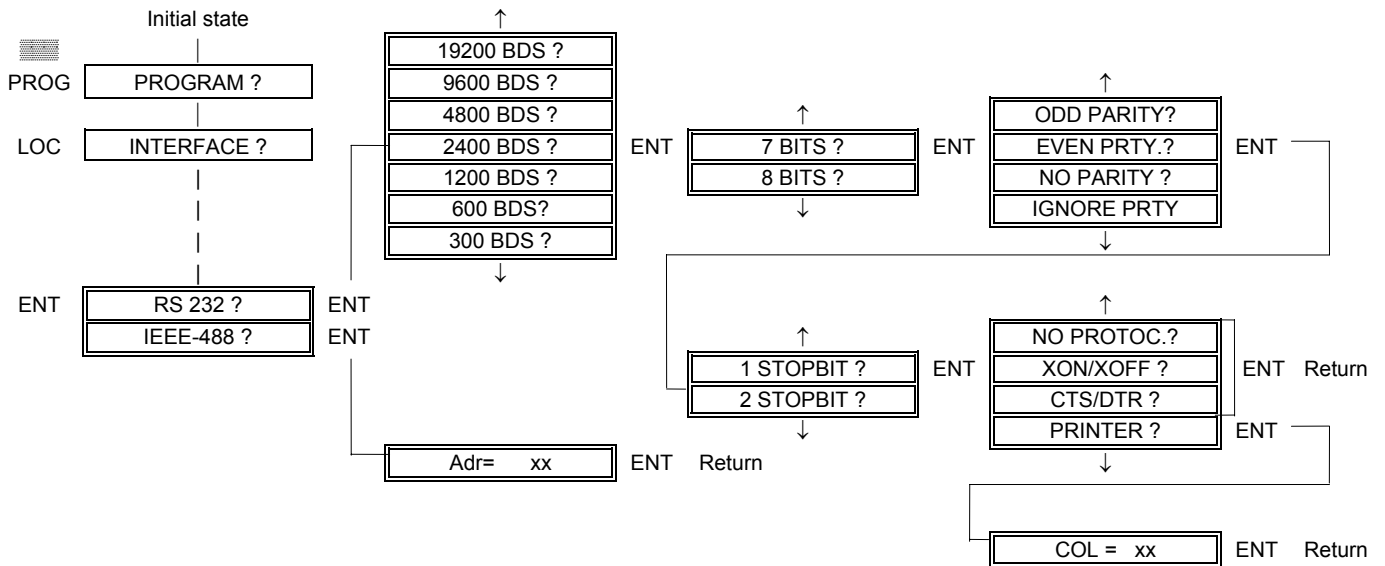

Display abbreviations

RS 232 ?
IEEE-488 ?

 Indicates the active interface which can be changed.

19200 BDS ?
9600 BDS ?
4800 BDS ?
2400 BDS ?
1200 BDS ?
600 BDS?
300 BDS ?

 Selects transmission data rate from 7 possible speeds. The first one to be displayed is the one which is active in memory. The data rate must be the same as that configured on the computer.

7 BITS ?
8 BITS ?

 Selects the number of bits which make up the "word" transmitted.

ODD PARITY?
EVEN PRTY.?
NO PARITY ?
IGNORE PRTY

 Selects the parity check option used to verify data transmission.

1 STOPBIT ?
2 STOPBIT ?

 Selects the number of stop bits.

NO PROTOC.?
XON/XOFF ?
CTS/DTR ?
PRINTER ?

 No protocol.
 XON/XOFF ? : Stops transmission when the buffer is full and restarts transmission when it is empty.
 CTS/DTR ? : Identical function to XON/XOFF except that control comes from the RS 232 data link lines.
 Selects printer mode.

Adr= xx

 Unit address on the IEEE-488 bus. Can be changed if necessary by the numerical keys (see § 6.1).
Programming limits: $00 \leq \text{Adr} \leq 30$.

COL = xx

 Number of columns used by the printer. Can be changed if necessary by the numerical keys (see § 6.1).
Programming limits: $1 \leq \text{COL} \leq 10$.

6.4.10 Language

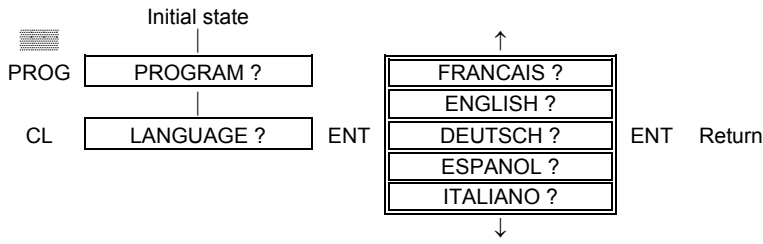

When an entry in the **LANGUAGE ?** procedure is validated by **ENT**, the display indicates the active language.

6.4.11 Instrument identity

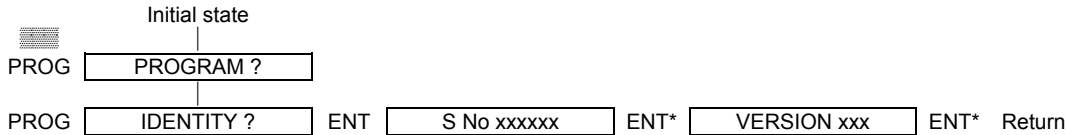

* If **ENT** is not pressed, the instrument displays its serial number for 4 seconds, the software version then returns to the initial state.

6.4.12 Analog output

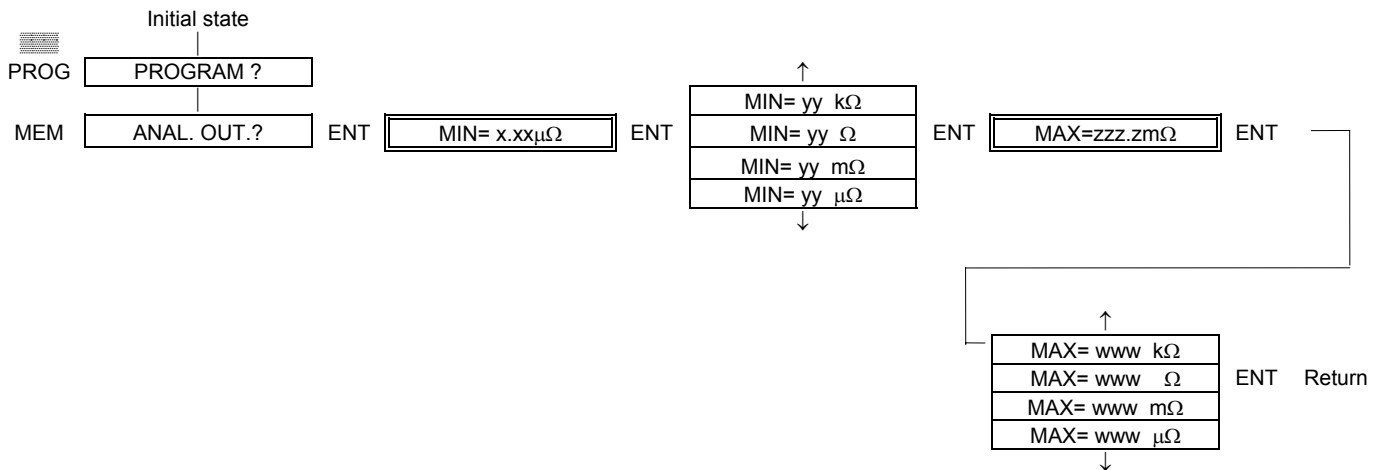

Display abbreviations

MIN= x.xxμΩ Resistance value corresponding to the minimum output voltage (0.00 V).

MAX=zzz.zmΩ Resistance value corresponding to the maximum output voltage (2.50 V).

Mxx=	kΩ	Selects the unit after changing minimum or maximum values.
Mxx=	Ω	
Mxx=	mΩ	
Mxx=	μΩ	

6.4.13 Alternate current mode

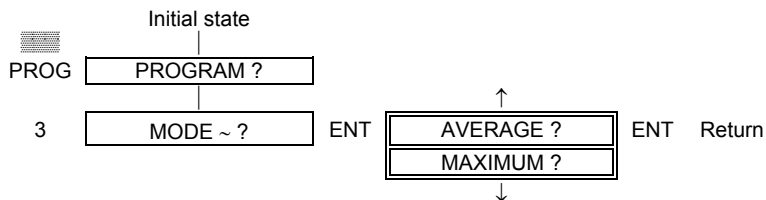

Display abbreviations

AVERAGE ?	Selects average or maximum values in both current directions.
MAXIMUM ?	

6.4.14 External current measurement

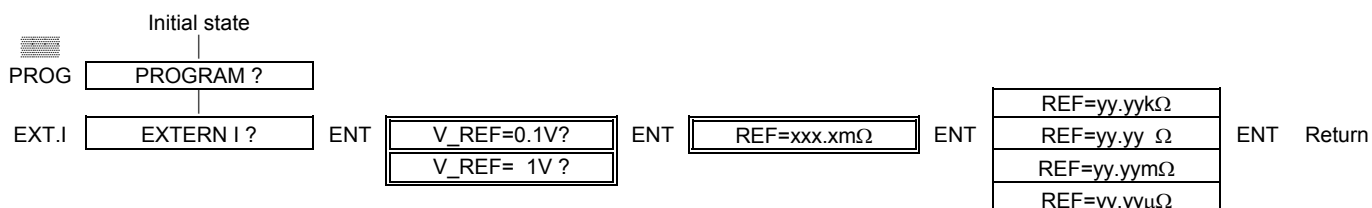

Display abbreviations

V_REF=0.1V?	Selects the rated voltage drop in the reference resistance: V_Ref = 0.1 V ± 20 %.
V_REF= 1V ?	
REF=xxx.xmΩ	Old value of the reference resistance, can be modified by numerical keys (see § 6.1).
REF=yy.yykΩ	Selects the unit after changing the reference resistance value.
REF=yy.yy Ω	
REF=yy.yymΩ	
REF=yy.yyμΩ	

6.4.15 Relative measurements (ΔR , $\Delta R/R$)

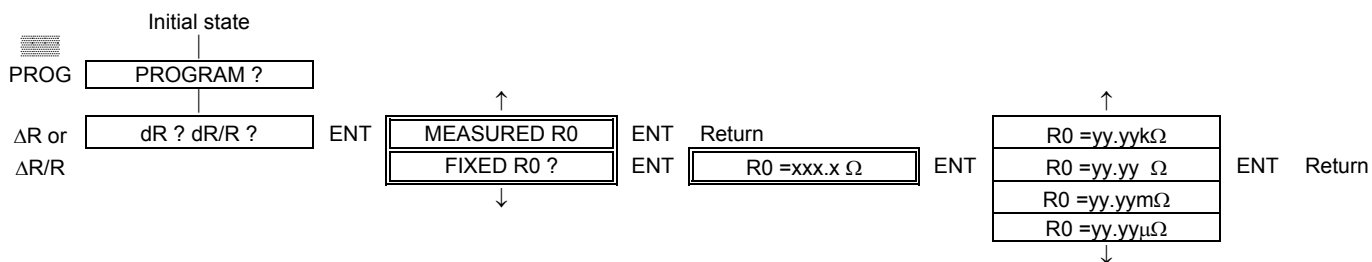

Display abbreviations

MEASURED R0	Indicates the old mode (measured or fixed reference resistance) which can be changed. If FIXED R0 ? is selected, the program proposes the old value.
FIXED R0 ?	
R0 =xxx.x Ω	Old value of the reference resistance, can be modified by numerical keys if necessary (see § 6.1).
R0 =yy.yykΩ	Selects the unit after changing the reference resistance R0.
R0 =yy.yy Ω	
R0 =yy.yymΩ	
R0 =yy.yyμΩ	

6.4.16 Temperature programs

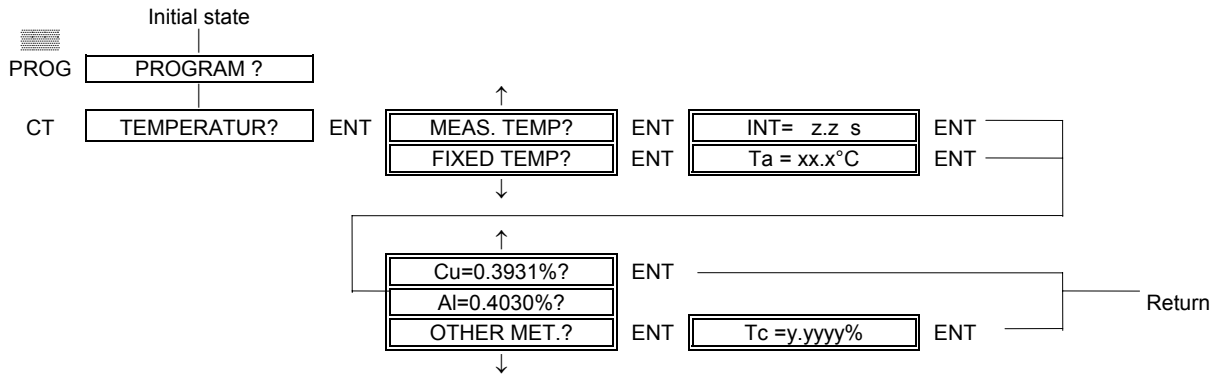

Display abbreviations

MEAS. TEMP? FIXED TEMP?	Indicates the old mode (measured or fixed temperature) which can be changed. If FIXED TEMP? is selected, the program proposes the value already in memory.
INT= z.z s	Old interval between two successive temperature measurements, which can be changed by numerical keys (see § 6.1). Programming limits: $60 \leq \text{INT} \leq 32\,400$.
Ta = xx.x°C	Old temperature value, which can be changed by numerical keys (see § 6.1).
Cu=0.3931%? Al=0.4030%? OTHER MET.?	Selects type of metal: copper, aluminum. If OTHER MET.? is chosen, the program proposes the old temperature coefficient.
Tc =y.yyyy%	Old temperature coefficient value, which can be changed by numerical keys (see § 6.1).

6.4.17 Measurement cycle

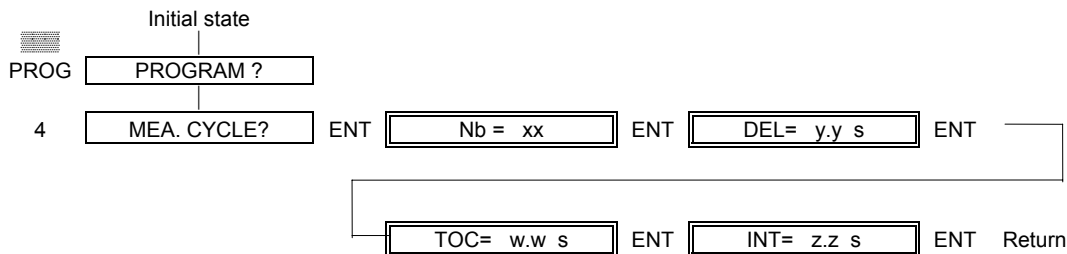

Display abbreviations

Nb = xx	Old number of measurements, which can be changed if necessary by numerical keys (see § 6.1). Programming limits: $0 \leq \text{Nb} \leq 65\,535$. Choosing "0" means that the number of measurements is infinite (the unit measures permanently).
DEL= y.y s	Old delay before first measurement, which can be changed if necessary by numerical keys (see § 6.1). Programming limits: $0 \leq \text{DEL} \leq 32\,400$.
TOC= w.w s	Old time of charge, which can be changed if necessary by the numerical keys (see § 6.1). Programming limits: $0.5 \leq \text{TOC} \leq 32\,400$.
INT= z.z s	Old interval between two measurements, which can be changed if necessary by numerical keys (see § 6.1). Programming limits: $0.5 \leq \text{INT} \leq 32\,400$.

6.4.18 Analog limit (clamping)

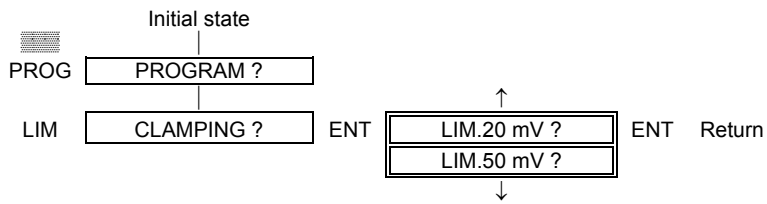

Display abbreviations

LIM.20 mV ?	Choose one of the two voltage limit values.
LIM.50 mV ?	

7. IEEE-488 and RS 232 interfaces

7.1 INTRODUCTION

The unit can be remotely controlled by an IEEE488 controller, a computer or a terminal, either via the asynchronous serial interface included as standard equipment on all instruments (RS 232), or by an optional IEEE-488 bus if installed.

For convenience, any unit or system capable of handling this remote control function will be referred to in this document as a controller.

The unit's IEEE-488 interface has been implemented with the following functions:

AH1 SH1 T6 L4 SR1 RL1 PP0 DC1 DT0 C0 E2

The remote control mode and parameters must be set from the instrument's keypad (see § 6.4.9).

Most remote commands and parameters are the same for both modes, with the exception of the following differences:

- the IEEE-488 option will only work when the unit is powered by the power supply.
- in RS 232 mode:
 - . remote control is possible during battery-powered operation,
 - . the REM, LLO and LOC commands replace the corresponding messages of the IEEE-488 mode,
 - . there is no service request facility (SRQ),
 - . the IEEE-488 bus handshake is replaced by a protocol.
 - . the unit can directly drive a printer if this option is selected.

7.2 SYNTAX

The unit's remote control commands meet the IEEE-488.2 standard.

7.2.1 Command messages

The controller talks to the unit by means of **command messages**. These messages can contain several elementary commands separated by <;> (hexadecimal code 3B or decimal code 59).

The message command must end with a **terminator**, as follows:

- either the character <LF> (hexadecimal code 0A or decimal code 10).
- or the message **EOI** on an IEEE-488 bus (line EOI active during the last character),
- or (<LF> + **EOI**).

In RS 232 mode, the terminator must always be an <LF>.

Characters in a message command can be either Upper or Lower Case.

Command message structure:

COMMAND1;COMMAND2;...;COMMANDn (EOI) or <LF> or (<LF> + EOI)

An elementary command which will be referred to as a **command**, is composed of a **header** followed by one or more **arguments** defining the command.

The header must be separated from arguments by at least one **space** <> (hexadecimal code 20 or decimal code 32) and arguments must be separated by <,> (hexadecimal code 2C or decimal code 44).

Extra spaces before or after header or arguments are ignored.

Command headers conforming to IEEE-488.2 standard all start with a <*> character.

Command structure:

HEADER ARGUMENT1,ARGUMENT2,...,ARGUMENTn

The unit recognizes two types of argument: **decimals** and **mnemonics**.

Decimals:

Decimal arguments are used to specify a whole or fractional numerical value. They are composed of a mantissa and an optional exponent and may optionally be followed by a **suffix** if necessary.

The mantissa is a whole or fractional number (the whole and fractional parts are separated by <.>), with or without a sign, including a maximum of 255 characters (non-significant head zeros <0> excluded).

The exponent is a signed or unsigned whole number, up to four figures long, between - 3 200 and + 3 200.

Mantissa and exponent are separated by the character <e> or <E>. Spaces before or after the "e" or "E" are ignored.

The suffix associates a unit (or a multiple or a submultiple) to the numerical value.

The units recognizes the following suffixes:

- UOHM ($\mu\Omega$), MOHM ($m\Omega$), OHM, KOHM ($k\Omega$).
- PCT (%).
- S (second).
- CEL ($^{\circ}C$).

Resistance values are expressed in Ohms by default.

Mnemonics:

Mnemonic arguments are used to specify optional parameters complementing a command. They are composed of a group of from one to twelve characters (alphanumeric or <_>) with a first alphabetic character.

The minimum and maximum number of arguments and the type of each one are specific to each command.

An optional argument can only be specified if it's predecessor has been.

In the body of a command, arguments and optional suffixes are specified within brackets [].

7.2.2 Response messages

Certain commands imply a response from the unit. The headers of these commands end with <?> and are referred to as **queries**.

When a command message contains queries, the unit prepares a response message which normally should have been acknowledged by the controller before any command message is sent.

As a message command may contain several queries, the responses are placed in the response message according to the query order and are separated by <;>.

A response message ends with:

- (<LF> + EO), IEEE bus,
- (<CR> + LF), RS 232.

A response can contain several **response elements** separated by <,>.

The IEEE-488.2 standard defines eleven types of response elements; the unit supports the following ones:

- Mnemonic.
- Signed or unsigned decimal whole numbers (NR1).
- Decimal fractional numbers with **fixed decimal point** (NR2).
- Character strings starting and finishing with <">.
- Eight-bit byte arbitrary block of indefinite length which always starts with #0.
- Eight-bit byte arbitrary block of definite length which always starts with #NX.X where:
N: non-zero numerical character,
X.X: N numerical characters representing in decimal notation the number of eight-bit bytes in the response element (not including #NX.X).
- Arbitrary block of 7 bit ASCII characters (except <LF>), always at the end of the message.

7.2.3 Detecting remote control errors

The IEEE-488.2 standard defines four types of error according to their cause and report in the Event Status Register ESR.

Command error:

Illegal command code (unknown header, illegal argument code, type or number of arguments different to those defined by the command). The command and all following message commands are not executed. The CDE bit of ESR is set to 1.

Execution error:

The command code is correct but cannot be executed as one or more arguments are out of the limits specified in the command or are mutually inconsistent. All following message commands are executed. The EXE bit of ESR is set to 1.

Instrument Error:

The command cannot be executed for reasons to do with the current state of the instrument. All following message commands are executed. The DDE bit of ESR is set to 1.

Query error: see exception procedures, § 7.2.7.

When an error occurs, an error message is stored in a fault queue which can contain up to 16 entries. Above 16, the first ones are discarded.

7.2.4 Instrument registers, service request

The unit contains several 8 or 16 bit registers able to generate a service request through the report and enable actions:

One condition register:

ISR (Instrument Status Register).

Two event registers:

ESR (standard Event Status Register).
ISCR (Instrument Status Change Register).

One status register:

STB (Status Byte) which stores the status word of the IEEE-488 interface each time a change occurs.

Three enable registers:

ESE (standard Event Status Enable).
SRE (Service Request Enable).
ISCE (Instrument Status Change Enable register).

Definition of register bits:

Bits:

7	6	5	4	3	2	1	0
---	---	---	---	---	---	---	---

16 bit registers only:

15	14	13	12	11	10	9	8
----	----	----	----	----	----	---	---

ISR, ISCR, ISCE:

PROB E	OVL	MEAS	ALAR M	HOLD	STBY	LOCK	REM
M_TA	LEAD	ACCU	OPEN I	OPEN U	HIEM F	OVR	CLAM P

ISCR register bits "REM", "LOCK" and "ALARM" are set to 1 when the corresponding ISR bit **changes state**; other bits are set to 1 only when their respective ISR bit **goes from 0 to 1**.

When an ISCR bit is set to 1, if the corresponding ISCE bit is at 1, the ISB bit of STB goes to 1.

REM:

Remote: only the LOC key is active.

LOCK:

Remote locked: only the controller can reset the instrument to **Local**.

STBY:

Returns the instrument to standby as defined in § 5.6.1.

HOLD:

At the end of a measurement cycle, the instrument goes to hold position as defined in § 5.6.3.

ALARM:

Goes from 0 to 1 at the beginning of an alarm and from 1 to 0 at the end of an alarm when the function is active.

MEAS:

Goes from 0 to 1 when a new measurement result is available.

OVL:

Overload: indicates the presence of an abnormal voltage on the instrument's inputs.

PROBE:

During ambient temperature measurements, indicates incorrect connections, an error value or the absence of a temperature sensor.

CLAMP:

Indicates an active voltage limit during a measurement when this function is active.

OVR:

Overrange: indicates an overrange of the active range when set to manual ranging, or an overrange of the highest range when set to autoranging.

HIEMF:

High E.M.F.: indicates an abnormally high value during offset voltage measurements (no current).

OPENU:

Indicates that the voltage circuit is open (terminals U).

OPENI:

Indicates an opening of or too high resistance across the current circuit (terminals I).

ACCU:

Indicates that the batteries which power the current source are discharged (OM 21), hence it is not possible to work with the 10 A and 1 A current ranges.

LEAD:

Indicates an incorrect connection of the component under test, in particular the inversion of the voltage circuit compared to the current circuit.

M_TA:

Goes from 0 to 1 when a new ambient temperature measurement is available.

Note: ISR and ISCR bits are set by both keypad and remote control commands.

ESR, ESE:

PON		CDE	EXE	DDE	QYE		OPC
-----	--	-----	-----	-----	-----	--	-----

When an ESR bit is set to 1, if the corresponding ESE bit is at 1, the ESB bit of STB goes to 1.

PON:

Set to 1 at each power on cycle of the instrument or each time the IEEE-488 interface is initialized, and each time the interface mode changes, (i.e.: each time the interface becomes active).

CDE:

Command error: unknown header or incorrect arguments. Subsequent message commands are not executed.

EXE:

Execution error: usually arguments out of limits. Subsequent message commands are executed.

DDE:

Instrument dependent error: usually arguments out of limits or inconsistent with the current state of the instrument. Subsequent message commands are executed.

QYE:

Query error: error acquiring a response message.

OPC

Operation complete: set to 1 after the command *OPC as soon as all pending commands are complete.

STB, SRE, status word:

	MSS		ESB	MAV	EAV	ISB	
	RQS						

When one of the status word bits (other than RQS) goes to 1 and the corresponding SRE bit is set to 1, the RQS bit in the status word and the MSS bit in STB are set to 1 and the SRQ bus line becomes active.

When the controller receives the IEEE-488 interface status word by initiating a **Serial Poll**, the interface unasserts the SRQ line and the RQS bit goes to 0, whereas the MSS bit in STB only goes to 0 when the service request has disappeared.

ESB:

Reports the status of the Event Status Register.

MAV:

Message available: at least one eight-bit byte available in the output buffer.

EAV:

Error message available: at least one error message available in the fault queue.

ISB:

Reports the status of the Instrument Status Change Register.

7.2.5 Input buffer

IEEE-488 mode:

Each eight-bit byte received by the unit is stored in a memory zone called an **input buffer**. This holds up to 128 eight-bit bytes and operates as a **first in first out** fashion (FIFO).

Each eight-bit byte of the input buffer is linked to an attribute which stores the state of the EOI line of the IEEE-488 interface and memorizes the GET message as a specific eight-bit byte.

The input buffer is transparent for the user, allowing the unit to receive data faster than it can decode them.

Once it is full, the unit inhibits the protocol "handshake" by pulling down the NRD (Not Ready For Data) line which is freed as soon as an eight-bit byte has been decoded, authorizing the controller to send a new eight-bit byte.

The input buffer is cleared during each power on cycle and each time a DCL (Device Clear) or SDC (Selected Device Clear) message is received on the IEEE-488 bus.

RS 232 mode:

The input buffer works in the same way, except for the following details:

- When in XON/XOFF protocol, if the input buffer contains more than 96 eight-bit bytes (75 %), the unit sends a Control/S (XOFF, hexadecimal 13 or decimal 19).

When the input buffer only contains 32 eight-bit bytes (25 %), it sends a Control/Q (XON, hexadecimal 11 or decimal 17).

When in CTS/DTR protocol, the CTS line of the serial interface is forced high or low as in XON/XOFF protocol (XON = +; XOFF = -).

If the controller ignores the protocol and the input buffer capacity is exceeded, the unit stores no further characters and sends an error code.

- Control/D (hexadecimal 04 or decimal 4) and Control/T (hexadecimal 14 or decimal 20) have the same function as DCL and SDC messages on the IEEE-488 bus.

7.2.6 Output buffer

IEEE-488 mode

Responses to queries are stored in a memory zone called an **output buffer** waiting till they are read by the controller. The output buffer holds up to 128 eight-bit bytes.

As soon as the unit is set to talk mode by the controller, the contents of the output buffer are sent over the bus, then once the whole of the response message has been received by the controller, the response terminator (<LF> + EOI) is sent over the bus.

RS 232 mode:

The output buffer works in the same way, except for the following details:

- In either protocol mode, the DTR line must be forced high before the serial interface can send characters.
- The interface only starts sending responses once the output buffer is full or a command message terminator has been decoded.
- In XON/XOFF protocol, the interface stops transmitting as soon as a Control/S (XOFF) has been received, and restarts transmitting as soon as a Control/Q (XON) has been received.

7.2.7 Exception procedures

If the controller does not follow IEEE-488.2 standard, exception procedures avoid total system hang ups.

INTERRUPTED:

The controller must read the response message before it attempts to send another command message. Otherwise, the QYE bit of ESR is set to 1, the output buffer is cleared and an INTERRUPTED error message is placed in the fault queue.

UNTERMINATED:

The controller must send a command message containing queries before it attempts to read a response message. Otherwise, the QYE bit of ESR is set to 1, the output buffer is cleared and an UNTERMINATED error message is placed in the fault queue.

DEADLOCKED:

A command message containing queries should not create a situation where the unit output buffer is full and there are still additional characters to be stored before the end of the message can be read. In this case the QYE bit of ESR is set to 1, the output buffer is cleared, a DEADLOCKED error message is placed in the fault queue and the rest of the command message is executed.

TRUNCATED RESPONSE:

When the response to a query should be placed as an arbitrary block of characters at the end of a message, it should not be followed by another query in the same command message. Otherwise, the QYE bit of ESR is set to 1, a TRUNCATED RESPONSE error message is placed in the fault queue and the responses to following queries are cleared from the response message.

7.2.8 Sequential and overlapped commands - commands ignored in local

Commands executed immediately as they are encountered are called sequential commands.

Commands that begin execution, but are completed some time later are called overlapped commands.

Most unit commands are sequential.

All commands which change unit configuration or the parameters stored in protected memory are ignored if the unit is in local mode. The DDE bit of ESR is set to 1 and a LOCAL error message is placed in the fault queue.

7.3 UNIT REMOTE COMMANDS

7.3.1 Commands defined by IEEE-488.2 standard (and usable in RS 232).

*CLS (sequential command)

Clears the ESR and ISCR.
Argument: none.

*ESE (sequential command)

Programs the Event Status Enable register.
Argument: decimal number between 0 and 255.

*ESE? (sequential command)

Returns the value from the Event Status Enable register.
Argument: none.
Response: decimal whole number between 0 and 255.

*ESR? (sequential command)

Returns the value from the Event Status Register and clears it.
Argument: none.
Response: decimal whole number between 0 and 255.

*SRE (sequential command)

Programs the Service Request Enable register.
Argument: decimal number between 0 and 255.

*SRE? (sequential command)

Returns the value from the Service Request Enable register.
Argument: none.
Response: decimal whole number between 0 and 255.

*STB? (sequential command)

Returns the value from the SStatus Byte register. Does not reset to 0 the MSS bit and asserts the SRQ line of IEEE-488 bus.
Argument: none.
Response: decimal whole number between 0 and 255.

*IDN? (sequential command)

Returns the instrument identification.
Argument: none.
Response: arbitrary block of characters with four fields separated by <, >.

AOIP_MESURES, OM21, Sxxxxxxx, X.xx

Sxxxxxxx (Serial number)
X.xx (Software version)

*OPC (sequential command)

Sets the OPC bit of ESR register to 1 when all pending operations are complete.
Argument: none.

*OPC? (sequential command)

Returns a 1 when all pending operations are complete.
Argument: none.
Response: decimal whole number "1".

***WAI** (sequential command)

Forces the unit to wait until all pending operations are complete.
Argument: none.

***TRG** (overlapped command)

Acts like the **OPER** command (same as the GET bus message).
Argument: none.

***RST** (sequential command)

Forces all pending commands to complete in the shortest possible time and resets the unit to its power on state (see § 5.2).
Argument: none.

***TST?** (sequential command)

Checks the integrity of the link between the analog and logic boards of the unit and controls the validity of the calibration coefficients.
Argument: none.
Response: decimal whole number according to the table:

0	No error.
1 to 0	Incorrect calibration coefficient: defective sequence number.
11	Defective link.

***PSC** (sequential command)

Checks the automatic reset of ESE and SRE registers to their power on state.
Argument: decimal number between - 32 767 and + 32 767.

If the argument = 0, ESE and SRE keep the value they had before the previous instrument reset, which allows a service request as soon as the instrument is powered up.

If not, ESE and SRE are reset to 0 on power up and no service request is allowed before ESE and SRE have been reprogrammed.

Example: *PSC 0; *ESE 128; *SRE 32
will provoke a service request at each power up cycle.

***PSC?** (sequential command)

Returns the status of the automatic reset flag of ESE and SRE.
Argument: none.
Response: decimal whole number 0 = no reset to 0.
1 = reset to 0.

7.3.2 Specific RS 232 mode commands

REM (sequential command)

Sets the instrument to remote control status; acts in the same way as the REN message of IEEE-488 bus.
Argument: none.

LOC (sequential command)

Resets the instrument to local status; acts in the same way as the GTL message of IEEE-488 bus.
Argument: none.

LLO (sequential command)

Inhibits a return to local mode using the LOC key; acts in the same way as the LLO message of IEEE-488 bus.
Argument: none.

7.3.3 Commands affecting unit specific registers

ISCE (sequential command)

Programs the Instrument Status Change Enable register.
Argument: decimal number between 0 and 65 535.

ISCE? (sequential command)

Returns the value from the ISCE register.
Argument: none.
Response: decimal whole number between 0 and 65 535.

ISR? (sequential command)

Returns but does not clear the value from the Instrument Status Register.
Argument: none.
Response: decimal whole number between 0 and 65 535.

ISCR? (sequential command)

Returns and clears the value from the Instrument Status Change Register.
Argument: none.
Response: decimal whole number between 0 and 65 535.

7.3.4 Commands affecting working characteristics

CURRENT (sequential command ignored in local)

Programs the measurement current and, if it is external, the reference voltage and resistance.

Arguments: I, [V_REF], [R_REF[UNIT]]

I, measurement current mnemonic (**EXT**, **A10** (OM 21), **A1**, **MA100**, **MA10**, **MA1**, **UA100**, **UA10** (OM 23)).
V_REF, optional mnemonic for external I reference voltage (**MV100**, **V1**).
R_REF, optional decimal number indicating the external I reference resistance value.
UNIT optional unit (**UOHM**, **MOHM**, **OHM**, **KOHM**, **OHM** by default).

CURRENT? (sequential command)

Returns the active measurement current and, if it is external, the reference voltage and resistance.

Argument: none.

Response:
- I internal: (mnemonic).
- I external: (mnemonic, mnemonic, decimal number, mnemonic).

Examples:
MA10
A1
EXT, MV100, 10.013, MOHM

RANGE (sequential command ignored in local)

Programs the specified range if it is compatible with the active current, **or** the range change mode (manual or automatic).

Argument: **RAN**

RAN, range mnemonic (**UOHM200** (OM 21), **MOHM2**, **MOHM20**, **MOHM200**, **OHM2**, **OHM20**, **OHM200**, **KOHM2**, **KOHM20**, **KOHM200** (OM 23), **MANUAL**, **AUTO**).

RANGE? (sequential command)

Returns the active range **and** the range change mode (manual or automatic).

Argument: none.

Response: (mnemonic, mnemonic).

Examples: `OHM200, AUTO`
`MOHM20, MANUAL`

MODE (sequential command ignored in local)

Programs the current mode (pulse, alternate or direct).

Argument: **MODE**, [**MAX/AVR**]

MODE, current mode mnemonic (**PULSE**, **ALTERNATE**, **DIRECT**)

MAX/AVR, optional mnemonic indicating the choice between maximum measurement (**MAX**) or average measurement (**AVR**) in alternate mode.

MODE? (sequential command)

Returns the active current mode and, in alternate mode, indicates the choice between maximum measurement and average measurement.

Argument: none.

Response: (mnemonic), [mnemonic].

7.3.5 Commands affecting the measurement cycle

CYCLE (sequential command ignored in local)

Defines for the OPER command the number of measurements, the delay before the first measurement and the interval between two measurements (§ 5.6.2).

The two last arguments (DEL and INT) are optional.

Arguments: **NB**, [**DEL[UNIT]**], [**INT[UNIT]**]

NB, whole number between 0 and 65 535.

DEL, decimal number between 0 and 32 400.

INT, decimal number between 0.5 and 32 400.

UNIT, unit <S> optional

CYCLE? (sequential command)

Returns the measurement cycle parameters and burst memory state.

Argument: none.

Response: (whole number, decimal number, decimal number, mnemonic (MEM_OFF, MEM_ON)).

Example: `20, 00003.0, 00000.5, MEM_ON`
(20 measurements, delay 3 s, interval 0.5 s, memory on).

TOC (sequential command ignored in local)

In direct current mode and for the OPER command, defines the switch current on time before the first measurement.

Argument: **TIME[UNIT]**

TIME, decimal number between 0.5 and 32 400.

UNIT, unit <S> optional.

TOC? (sequential command)

Returns the switch current on time in direct current mode.

Argument: none.

Response: (decimal number).

Example: `00003.0`

OPER (overlapped command ignored in local)

Triggers a measurement cycle (refer to the manual command OPER § 5.6.2).

Argument: none.

MEAS? (sequential command)

Returns the value of the last measurement recorded (absolute value, no compensation) or, in case of malfunction, a predefined value (§ 5.7.4).

Argument: none.

Response: (decimal number, mnemonic).

Examples: `125.09, MOHM`
`203.47, OHM`
`30.000, KOHM` (out of range, bit OVR of ISR to 1)

DSP? (sequential command)

Returns the value of the last measurement displayed (absolute or relative value, temperature compensated value) or, in case of malfunction, a predefined value (§ 5.7.4).

Argument: none.

Response: (decimal number, mnemonic).

Examples: `-01.35, MOHM`
`002.19, PCT`

HEAT? (sequential command)

Returns the value of the last heating measurement.

Argument: none.

Response: (decimal number, mnemonic).

Example: `36.5, CEL`

TEMP? (sequential command)

Returns the value of the last ambient temperature measurement.

Argument: none.

Response: (decimal number, mnemonic).

Example: `25.3, CEL`

STBY (overlapped command ignored in local)

Returns the instrument to standby position (§ 5.6.1).

Argument: none.

7.3.6 Commands affecting other functions

CLAMP (sequential command ignored in local)

Activates or deactivates the analog limits.

Argument: mnemonic

OFF, deactivates the stored limit.
ON, activates the stored limit.
MV20, activates the 20 mV limit.
MV50, activates the 50 mV limit.

CLAMP? (sequential command)

Returns the stored limit and its state.

Argument: none.

Response: (mnemonic, mnemonic).

Example: `MV20,OFF`

ALARMS (sequential command ignored in local)

Activates or deactivates alarm function.

Argument: **ON** or **OFF**.

ALARMS? (sequential command)

Returns the alarm function status.

Argument: none.

Response: (mnemonic), ON or OFF.

LIM_1 (sequential command ignored in local)

Programs the alarm limit 1.

Argument: **DIR**, [**VAL**[UNIT]], [**HYST**[UNIT]]

DIR, mnemonic indicating the direction of overrun of the limit which triggers the alarm:
- **HI** for values higher than limit,
- **LO** for values lower than the limit.
VAL, decimal number indicating the value of the limit 1.
HYST, decimal number indicating the hysteresis value of the limit 1.
UNIT, optional unit (**UOHM**, **MOHM**, **OHM**, **KOHM**, **OHM** by default).

Example: `LIM_1 HI,12.5KOHM,100`

LIM_2 (sequential command ignored in local)

Programs the alarm limit 2.

Argument: **DIR**, [**VAL**[UNIT]], [**HYST**[UNIT]]

DIR, mnemonic indicating the direction of overrun of the limit which triggers the alarm:
- **HI** for values higher than the limit,
- **LO** for values lower than the limit.
VAL, decimal number indicating the value of limit 2.
HYST, decimal number indicating the hysteresis value of limit 2.
UNIT, optional unit (**UOHM**, **MOHM**, **OHM**, **KOHM**, **OHM** by default).

Example: `LIM_2 LO,11.5KOHM,100OHM`

LIM_1? (sequential command)

Returns the current programming of limit 1.

Argument: none.

Response: (mnemonic, decimal number, mnemonic, decimal number, mnemonic).
Value of limit and hysteresis have the same unit.

Example: `HI,12.500,KOHM,00.100,KOHM`

LIM_2? (sequential command)

Returns the current programming of limit 2.

Argument: none.

Response: (mnemonic, decimal number, mnemonic, decimal number, mnemonic).
Value of limit and hysteresis have the same unit.

Example: `LO,11.500,KOHM,00.100,KOHM`

MEAS_REL (sequential command ignored in local)

Activates or deactivates measurements of DR and dR/R.

Argument: mnemonic

OFF, deactivates the two functions.
DR, activates the function DR.
DR_R, activates the function DR/R.

REF_DR (sequential command ignored in local)

Programs the choice between measured or fixed reference value (R0) and, in the latter case, stores the new value.

Arguments: **MODE**, [**VAL**[UNIT]]

MODE, mnemonic indicating R0 measured (MEAS) or R0 fixed (FIXED).
VAL, decimal number indicating the value of R0.
UNIT, optional unit (**UOHM**, **MOHM**, **OHM**, **KOHM**, **OHM** by default).

Examples: `REF_DR FIXED,100MOHM`
`REF_DR MEAS`
`REF_DR FIXED` (stores the value of R0 in memory)

MEAS_REL? (sequential command)

Returns the status of relative measurement functions, the entry mode of reference value R0 and its value.

Argument: none.

Response: (mnemonic, mnemonic, decimal number, mnemonic)

Examples: `DR_R,MEAS,101.05,MOHM`
`OFF,FIXED,15.728,OHM`

MEAS_RT (sequential command ignored in local)

Activates or deactivates temperature compensated measurements (resistance at 20°C).

Argument: **ACT**, [**NO**]

ACT, mnemonic **ON** or **OFF**.
NO, optional whole number (if **ON**), between 0 and 9, indicating the "Rt" memory number where the measurement should be stored.

MEAS_DT (sequential command ignored in local)

Activates or deactivates heating measurement.

Argument: **ACT**, [**NO**]

ACT, mnemonic **ON** or **OFF**.

NO, optional whole number (if **ON**), between 0 and 9, indicating the "Rt" memory number containing the cold state measurement.

STORE_RT (sequential command ignored in local)

Enters a resistance value in the "Rt" memory.

Arguments: **NO**, **VAL**[**UNIT**]

NO, whole number between 0 and 9 indicating the "Rt" memory number.

VAL, decimal number indicating the resistance value to be stored.

UNIT, optional unit (**OHM** by default).

Examples: STORE_RT 7, 125.34MOHM

TEMP (sequential command ignored in local)

Choice of entry mode of the ambient temperature between measured value and numerical entry and, in the latter case, the optional new temperature value.

Arguments: **MODE**, [**VAL**[**UNIT**]]

MODE, mnemonic indicating measured temperature (**MEAS**) or fixed temperature (**FIXED**).

VAL, decimal number indicating:

- in measured temperature, the time interval between two successive temperature measurements with its optional unit (**S**),

- in fixed temperature, the value of the ambient temperature with its optional unit (**CEL**).

Examples: TEMP MEAS,60 s
TEMP FIXED,28.5

METAL (sequential command ignored in local)

Choice of the metal type and of its temperature coefficient.

Arguments: **TYPE**, [**VAL**[**UNIT**]]

TYPE, mnemonic indicating metal type:

- **CU**, copper, Tc = 0.3931 %/°C.

- **AL**, aluminum, Tc = 0.4030 %/°C.

- **OTHER**, another metal or temperature coefficients different from those set for copper and aluminum.

VAL, decimal number indicating the temperature coefficient of metals other than those of copper or aluminum proposed.

UNIT, optional unit (PCT = %/°C).

Examples: METAL OTHER,0.00391
METAL OTHER,0.391PCT
METAL CU
METAL OTHER (remainder of coefficient
0.391 %/°C previously stored).

KEYB (sequential command ignored in local)

Argument: mnemonic **OFF** or **ON**.

OFF inhibits the keyboard keys, except **OPER**, **STBY** and **CM**.

ON validates the keyboard keys.

LIGHT (sequential command ignored in local)

Argument: mnemonic **OFF** or **ON**.

Switches the display lighting ON or OFF.

MEAS_CT? (sequential command)

Returns the status of functions linked to the temperature of component under test, the temperature entry mode, the metal type and its temperature coefficient.

Argument: none.

Response: (mnemonic, mnemonic, decimal number, mnemonic, decimal number, mnemonic).

Examples:

OFF,MEAS,00060.0,S,CU,0.3931,PCT
RT,FIXED,028.5,CEL,OTHER,0.3910,PCT

MEM_RT? (sequential command)

Returns the contents of the memory with 10 resistance values reduced to 20°C (Rt0 to Rt9).

Argument: none.

Response: eight-bit byte block of definite length.

Example:

```
#40131
10.014 MOHM (memory n° 0)
198.05 MOHM (memory n° 1)
04.832 OHM (memory n° 2)
.....
08.547 KOHM (memory n° 9)
```

MEMRT? (sequential command)

Returns the contents of the memory with 10 resistance values reduced to 20°C (Rt0 to Rt9) and corresponding time of charge.

Argument: none.

Response: eight-bit byte block of definite length.

Example:

```
#40232
10.014 MOHM,00000.5 S (memory n° 0)
198.05 MOHM,00002.5 S (memory n° 1)
04.832 OHM,00004.0 S (memory n° 2)
.....
08.547 KOHM,00008.5 S (memory n° 9)
```

OUT_ANA (sequential command ignored in local)

Programs the analog output setup parameters.

Argument: **MIN** [**UNIT**],[**MAX**[**UNIT**]]

MIN, decimal number corresponding to the output 0 V.

MAX, decimal number corresponding to the output 2.50 V.

UNIT, optional unit (**UOHM**, **MOHM**, **OHM**, **KOHM**, **OHM** by default)

Examples: OUT_ANA 0,15MOHM
OUT_ANA 5MOHM (modification of MIN
exclusively)

OUT_ANA? (sequential command)

Returns the analog output setup parameters.

Argument: none.

Response: (decimal number, mnemonic, decimal number, mnemonic).

Example: 05.000,MOHM,15.000,MOHM

RPUL (sequential command ignored in local)

Activates or deactivates the cable resistance measurements and programs the parameters.

Arguments : **ACT** [,LENG[,BRINS]]

ACT, mnemonic ON or OFF.
LENG, decimal number indicating the cable length in meters (100 ≤ LENG ≤ 9 999).
BRINS, decimal number indicating the number of wires (1 ≤ BRINS ≤ 100).

RPUL? (sequential command)

Returns status and parameters from the cable resistance measurements.

Arguments : none.

Response: mnemonic, decimal number, decimal number.

Example : ON,1200.0,10 (ON, 1 200 m, 10 wires).

7.3.7 Commands affecting the burst memory

MEMORY (sequential command ignored in local)

Activates or deactivates the measurement memory.

Argument: **OFF** or **ON**.

MEMORY? (sequential command)

Returns the summary contents of the measurement memory, i.e. the number of bursts and, for each burst (numbered from B_00 to B_49 max.), the number of measurements and the measurement current (in external I, remainder of the reference resistance value).

Argument: none.
Response: eight-bit byte block of indefinite length.

Example 1 (memory empty):

```
#0
00 BURST
```

Example 2:

```
#0
04 BURST
B_00,0021 MEAS,MA100
B_01,0063 MEAS,A1
B_02,0178 MEAS,MA10
B_03,0045 MEAS,EXT,10.014,MOHM
```

BURST? (sequential command)

Returns the number of bursts recorded.

Argument: none.
Response: (decimal number).

Example: 15

OUT_BURST? (sequential command)

Returns, without argument, the contents of the last burst recorded, or the contents of the burst with the number contained in the argument. If this number is higher than number of bursts recorded, returns the number of bursts.

Arguments (optional): **[NO]**, **[TYPE]**

NO, whole number between 0 and 49.
TYPE, mnemonic indicating the value of measurement returned:
- **DR**, relative measurement (R - R0)
- **DR_R**, relative measurement (R - R0 / R0)
- by default, absolute value or value reduced to 20°C.

Response: eight-bit byte block of indefinite length.

Line 1:
#0

Line 2:
00 BURST (memory empty)
xx BURST (argument too large)
B_xx (output burst n° xx)

Line 3:
xxxx MEAS,ABS,(VAL) (UNIT)
(absolute measurement, R0 value = 0)
or
xxxx MEAS,REL,(VAL) (UNIT)
(relative measurement, R0 value)
or
xxxx MEAS,RT,(VAL) (UNIT)
(measurement reduced to 20°C, R0 value)
or
xxxx MEAS,DT,(VAL) (UNIT)
(heating measurement, Rt value)

Line 4:
CURRENT [I],(VAL) (UNIT)
(current mnemonic, internal Rref)
or
CURRENT EXT,(VAL) (UNIT)
(external Rref)

Line 5:
(current mode mnemonic) MODE

Line 6:
INT : xxxxx.x S (Interval between measurements)

Lines 7, 8, 9:
MAX : (VAL) (UNIT) (maximum value)
MIN : (VAL) (UNIT) (minimum value)
AVR : (VAL) (UNIT) (average value)

Line 10:
TA : (VAL) CEL, TC : (VAL) PCT
(if Rt or Dt measurement)
TA : 020.0 CEL, TC : 0.0000 PCT
(if measurement independent of T)

Line 11:
DT : (VAL) CEL (if Dt measurement)
DT : 000.0 CEL (other measurements)

Following lines, measurements values with option TYPE:
(VAL) (UNIT) (measurement 0 of the burst)
(VAL) (UNIT) (measurement 1 of the burst)
.....
(VAL) (UNIT) (last measurement of the burst)

Example 1: OUT_BURST? 45
(output of contents of burst n° 45 when the memory only contains 10 bursts).

```
#0
10 BURST
```

Example 2: OUT_BURST? 5
(output of contents of burst n° 5 containing 4 absolute measurements).

```
#0
B_05
0004 MEAS,ABS,000.00 UOHM
CURRENT MA100,1.0000 OHM
PULSE MODE
INT : 00001.5 S
MAX : 115.24 MOHM
MIN : 115.20 MOHM
AVR : 115.22 MOHM
TA : 020.0 CEL, TC : 0.0000 PCT
DT : 000.0 CEL
115.20 MOHM
115.23 MOHM
115.21 MOHM
115.24 MOHM
```

Example 3: OUT_BURST? 7,RT
(output of contents of burst n° 7 containing 3 measurements with temperature compensation).

```
#0
B_07
0003 MEAS,RT,000.00 UOHM
CURRENT EXT,10.115 MOHM
DIRECT MODE
INT : 00001.0 S
MAX : 17.543 MOHM
MIN : 17.539 MOHM
AVR : 17.540 MOHM
TA : 025.4 CEL, TC : 0.3931 PCT
DT : 000.0 CEL
17.543 MOHM
17.539 MOHM
17.539 MOHM
```

OUTBURST? (sequential command)

Without argument, returns the contents of the last recorded burst or the contents of the burst having the number specified as argument. If this number is higher than the number of recorded bursts, returns the number of bursts.

Argument (optional) : **[NO]** , whole number between 0 and 49.
Response : eight-bit byte of indefinite length.

Line 1 :
#0

Line 2 :
00 BURST (empty memory)
xx BURST (argument too large)
B_xx (output burst n° xx)

Line 3 :
xxxx MEAS,ABS (absolute measurement)
or
xxxx MEAS,RT (measurement reduced to 20°C)
or
xxxx MEAS,DT (heating measurement)

Line 4 :
(current mode mnemonic) MODE

Line 5 :
CURRENT [I],REF (VAL) (UNIT)
(current mnemonic, reference resistance)

Line 6 :
R0 (VAL) (UNIT),RT (VAL) (UNIT)
(R0 value, relative measurements),
(RT value, heating measurements)

Line 7 :
INT xxxxxx.x S,TOC xxxxxx.x S,T1 xxxxxx.x S
(Interval between measurements, time of charge, time of the first measurement in heating measurement).

Line 8 :
TA (VAL) CEL,TC (VAL) PCT,DT (VAL) CEL
(ambient temperature, temperature coefficient, heating).

Line 9 :
VOFS (VAL) MV
(measurement of the stray emf in direct current mode).

Line 10 :
^ (record separator, decimal code 30).

Lines following, measurement values:
(VAL) (UNIT) (burst measurement 0)
(VAL) (UNIT) (burst measurement 1)
.....
(VAL) (UNIT) (burst last measurement)

Last lines:
^ (record separator, decimal code 30).
MAX (VAL UNIT),MIN (VAL UNIT),AVR (VAL UNIT)
(maximum, minimum and average value).
→ (RS232 only: file end, decimal code 26).

Example 1 : OUTBURST? 45
(output of burst n° 45 contents while the memory only contains 10 bursts).

```
#0
10 BURST
→
```

Example 2 : OUTBURST? 3
(output of burst n° 3 contents which contains 24 measurements in heating measurement).

```
#0
B_03
24 MEAS,DT
DIRECT MODE
CURRENT A1,REF 100.00 MOHM
R0 000.00 UOHM,RT 2.0461 OHM
INT 00001.0 S,TOC 00002.5 S,T1 00006.0 S
TA 023.7 CEL,TC 0.3931 PCT,DT 21.4 CEL
VOFS -000.2 MV
^
2.0704 OHM
2.0698 OHM
2.0692 OHM
.....
2.0572 OHM
^
MAX 2.0704 OHM,MIN 2.0572 OHM,AVR 2.0651 OHM
→
```

OUT_MEMORY? (sequential command)

Returns the contents (absolute measurements) of all the bursts into memory.

Argument: none.

Response: eight-bit byte block of indefinite length.

- if the memory is empty:
#0
00 BURST

- if the memory contains "n" bursts:
 #0
 (identical to OUT_BURST? 0)
 (identical to OUT_BURST? 1)

 (identical to OUT_BURST? n-1)

OUTMEMORY? (sequential command)

Returns the contents (absolute measurements) of all the bursts into memory.

Argument : none.

Response: eight-bit byte block of indefinite length.

- if the memory is empty:
 #0
 00 BURST

- if the memory contains "n" bursts:
 #0
 (same as OUTBURST? 0)
 (same as OUTBURST? 1)

 (same as OUTBURST? n-1)
 → (RS232 only, file end, decimal code 26)

DEL_BURST (sequential command ignored in local)

Deletes the burst whose number is indicated in the argument.

Argument: whole number between 0 and 49.

DEL_MEMORY (sequential command ignored in local)

WARNING: this command deletes all the measurement memory.

Argument: none.

7.3.8 Error commands

The 16 last errors detected during decoding or execution of commands are stored in a fault queue.

The EAV bit of STB is set to 1 as long as there is at least an error message in the queue.

CL_ERR (sequential command)

Clears all error messages and resets EAV bit to 0.

Argument: none.

ERR_NO? (sequential command)

Returns the most recent error number and clears the corresponding message in the queue. If there are no more error messages waiting, the EAV bit is reset to 0.

Argument: none.

Response: decimal whole number, 0 if no error.

ERR? (sequential command)

Returns the message corresponding to the most recent error or the error number contained in the argument.

Argument: optional decimal number between 0 and 27.

Response: character string between <">.

- No argument, the command ERR? acts just like ERR_NO? towards the fault queue.
 - With argument, the fault queue is not modified.

Table of errors	
Error n°	Message
0	"NONE ERROR"
1	"UNTERMINATED"
2	"INTERRUPTED"
3	"DEADLOCKED"
4	"TRUNCATED RESPONSE"
5	"UNKNOWN HEADER"
6	"GET ENCOUNTERED"
7	"WRONG ARG. TYPE"
8	"WRONG ARG. NO."
9	"OVERLIMIT ARG."
10	"UNKNOWN MNEMONIC"
11	"WRONG SUFFIX"
12	"ARG. TOO LONG"
13	"WRONG ARG."
14	"LOCAL"
15	DEVICE ERROR"
16	"TRIG. IN PROGRESS"
17	"WAIT DISCHARGE"
18	"OVERLOAD"
19	"OVERRANGE"
20	"CURRENT TOO HIGH"
21	"OPEN U"
22	"OPEN I"
23	"CLAMPING"
24	"HIGH EMF"
25	"CONNECTION ERROR"
26	"CALIBRATION ERROR"
27	"PROBE ERROR"
28	"INPUT BUFFER FULL"
29	"WRONG ERROR NO."

8. MAINTENANCE

In view of the precautions required and the risks involved, all maintenance procedures must be undertaken by qualified personnel, adequately trained and documented. AOIP offers a full maintenance and calibration service in its factory and assumes no risk for repair or calibration activities undertaken by other personnel.

All maintenance operations must be performed on a totally disconnected unit, except for those relating to the battery charger.

8.1 OPENING THE UPPER AND LOWER COVERS

- Disconnect the instrument from the power supply and from all electrical cabling wired to both front and rear panel terminal blocks.

- Using a screwdriver, unscrew the 4 cover screws on the side to be opened, each cover is fixed by 2 short screws at the rear and 2 long screws at the sides.
- Lift the cover and pull towards the rear of the instrument.

The upper cover provides access to:

- . the logic board which holds the 12 V battery and the charger board,
- . optionally the IEEE-488 board, according to model.

The lower cover provides access to:

- . the analog board.

8.2 CLOSING THE CASE

- Align the two tabs on the cover into the slots in the case, pushing the cover into position.
- Insert the 4 screws into the cover to complete replacement onto case.

WARNING: The 2 short screws go in the holes at the rear of the instrument and the 2 long screws go in the sides.

8.3 REPLACING FUSES

8.3.1 Power fuse

The instrument's power supply is protected by a time-lag 5 x 20 fuse rated 160 mA/250 V, according to standard NF C 60-430 (sheet III).

If the "~" indicator does not light up when the instrument is connected to power supply, replace the fuse as follows:

- Switch off the instrument, disconnect the power cord as well as all wires connected to the front or back of the instrument.
- Open the upper cover as described in § 8.1. The fuse is located on the logic board as shown in the following diagram:

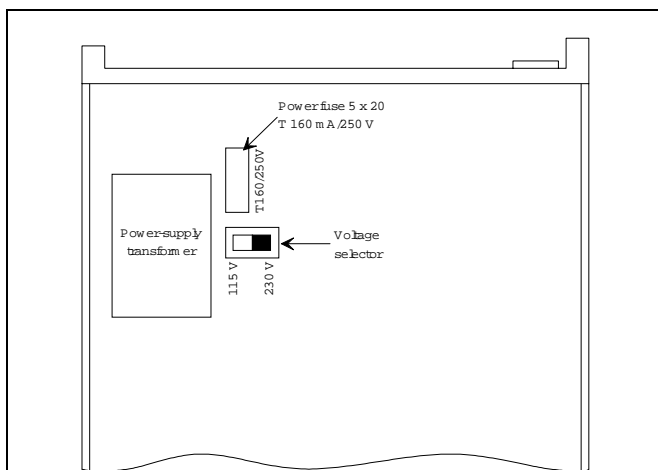

- Remove the fuse cover.
- Insert the blade of a small screwdriver between the fuse and its support, exerting light pressure to push it up and out of its clips.

- Check that the fuse is blown, and identify the malfunction which caused it to blow.
- Replace the fuse with an identical part: AOIP part number ER 48124-161.
- Put back the fuse cover.
- Close up the instrument as described in § 8.2.

8.3.2 Current circuit fuse

The analog board current circuit is protected by:

- a 6.3 x 32 instantaneous fuse rated 16 A/250 V, specially made to ensure low voltage drop (standard NF C 93-435, model HA 39) for the OM 21 (AOIP part number: AN 8009).
- a 6.3 x 32 fast-acting fuse rated 2 A/380 V for the OM 23 (AOIP part number: AN 5826).

If, as a result of a manipulation error, the unit outputs no current to the "I" terminals, check if this fuse is blown, that no other component nearby is damaged or destroyed, and only then **replace it with an identical component**.

To replace it:

- Switch off the instrument, disconnect the power cord as well as all wires connected to the front or back of the instrument.
- Open the lower cover as described in § 8.1. The fuse is located on the analog board, near the rear terminal block.
- Replace the fuse and close the instrument as described in § 8.2.

8.4 POWER SUPPLY 230 V OR 115 V

To change power supply:

- Switch off the instrument, disconnect the power cord as well as all wires connected to the front or back of the instrument.
- Open the upper cover as described in § 8.1.
- Move the "voltage selector" to the desired position as indicated on the diagram in § 8.3.1.
- Add a label indicating the new voltage under the plug fixed to the rear panel.

8.5 SERVICING THE BATTERY PACK (OM 21)

Models OM 21-2 and OM 21-4 are equipped with a 12 V battery pack. This is contained in a molded tight pack allowing operation in any position. This battery normally needs no servicing other than making sure it is adequately charged.

8.5.1 Normal usage

As soon as the instrument is connected to power supply, the red indicator (~), to the right of the keypad lights up indicating power presence; the internal charger recharges the battery according to its discharge level, independently whether the instrument is working or not.

When working independently, the user is warned the battery should be recharged by the appearance of a symbol **BAT** on the display.

At that point there remains approx. 20 % of a full charge, i.e. after a certain period varying from 30 to 90 minutes, according to usage, the instrument will switch off automatically and it will no longer be possible to switch it back on. **The battery must be immediately recharged if irreversible damage is to be avoided.**

To do this, plug the instrument back into power supply, the red indicator lights up. The battery recharges itself. A full charge takes from 12 to 14 hours if the instrument is not being used. Beyond this time, the charger limits the current feed and the instrument can stay plugged in for an unlimited time.

8.5.2 Storage

Unit battery life is improved if the following advice is followed:

- Never store an instrument whose battery is completely discharged.
- Recharge it after each period of usage, do not just wait for the **BAT** symbol to appear before recharging.
- After a complete discharge and an automatic cut-out, anything more than a few days in this state can reduce the nominal charge capacity of the battery and the unit will lose some of its autonomy.

If long-term storage is envisaged, remember that a lead battery always has a certain current leakage, depending on ambient temperature. Periodic top-up recharging is advisable in order to compensate this natural tendency to self-discharge:

- with a totally charged battery, storage at temperatures below 25°C requires top-up recharging every 12 months,
- storage at temperatures from 30°C to 40°C requires top-up recharging approximately every 6 months.

8.5.3 Replacing the battery pack

In case of battery abnormal operation or if the life is highly reduced regarding that indicated in the technical specifications, the user may replace the battery with an identical part (tight lead battery pack, 12 V, 1.8 to 2.0 Ah), AOIP part number : ER 41206-003.

8.6 EXTERNAL POWER SUPPLY (OM 21)

To install the current source external power supply:

- connect the 3 V external power supply and **follow the polarity**,
- using a screwdriver, set the "source" switch to external position (slot via the "3 V" input terminals).

8.7 PERFORMANCE VERIFICATION

The instrument's performance to specification is checked exhaustively at the factory before shipment.

However the user may need to verify exact performance characteristics as part of the company's metrology and quality policy.

This check should take into account normal metrological procedure and usage and in particular the following advice should be followed:

- All operations should be performed in the following reference conditions: temperature: 23°C ± 1°C, relative humidity: 45 % to 75 %.
- The calibration standards used for performance verification or calibration should be chosen to ensure that the accuracy across the verification or calibration terminals is known and, for the unit, is equal or better than ± 0.01 %, taking into account the influence factors present.

After this verification, if one or more performance characteristics of the unit are outside specified tolerances, the instrument can be recalibrated by the user.

The unit calibration is explained in a maintenance document, AOIP part number: NT 45942-190A.

9. Warranty

The unit is covered by a one year factory warranty, including parts and labor, against any defect encountered during normal usage, excluding any faults caused by abnormal usage or repairs by personnel other than those qualified by AOIP.

In case of malfunction, send the instrument back to the address indicated below or to a repair laboratory approved by AOIP to ensure the repair quality and the calibration accuracy as specified in paragraph 4.2.

AOIP INSTRUMENTATION
Service Après-Vente
Zone industrielle de Saint-Guénault
Rue Maryse Bastié
B.P 182 - 91006 EVRY CEDEX - FRANCE

Tel : +33 1 69 36 50 50

10. Appendix I - Summary of the specific commands

KEY:

CURRENT : mnemonic.
 resistance : numerical value.
OHM : default unit.

 HEADER

 COMPULSORY ARGUMENT.

 OPTIONAL ARGUMENT.

Table of unit specific interrogations

Command	Response						
CURRENT?	Measurement current.						
RANGE?	Measurement range and mode.						
MODE?	Measurement current mode.						
CYCLE?	Measurement cycle.						
TOC?	Current time of charge in direct current mode.						
MEAS?	Last measurement ("absolute value").						
DSP?	Last measurement ("displayed" value).						
HEAT?	Last heating measurement.						
TEMP?	Last ambient temperature measurement.						
CLAMP?	Analog limit status.						
ALARMS?	Alarm status.						
LIM_1?	Alarm 1 setpoint.						
LIM_2?	Alarm 2 setpoint.						
MEAS_REL?	Relative measurement status.						
MEAS_CT?	Status of measurements dependent of the temperature.						
MEM_RT?	Contents of the 10 RT memories.						
MEMRT?	Contents of the 10 RT memories and corresponding time of charge.						
OUT_ANA?	Analog output setpoints.						
RPUL?	Status and parameters of the cable resistance measurement.						
MEMORY?	Contents of burst memory.						
BURST?	Number of bursts saved.						
OUT_BURST?	<table border="0" style="display: inline-table; vertical-align: middle;"> <tr> <td style="border: 1px solid black; padding: 2px; text-align: center;">Burst number</td> <td style="padding: 0 10px;">,</td> <td style="border: 1px solid black; padding: 2px; text-align: center;">DR</td> </tr> <tr> <td></td> <td></td> <td style="border: 1px solid black; padding: 2px; text-align: center;">DR_R</td> </tr> </table> Contents of the last burst or contents of the numbered burst.	Burst number	,	DR			DR_R
Burst number	,	DR					
		DR_R					

Command**Response**

<input type="text" value="OUTBURST?"/>	<input type="text" value="Burst number"/>	Contents of the last burst or contents of the numbered burst.
<input type="text" value="OUT_MEMORY?"/>		Contents of all bursts saved.
<input type="text" value="OUTMEMORY?"/>		Contents of all bursts saved.
<input type="text" value="ERR_NO?"/>		
<input type="text" value="ERR?"/>	<input type="text" value="Number"/>	

Table of unit specific commands

CURRENT	EXT A10 (OM21) A1 MA100 MA10 MA1 UA100 UA10 (OM23)	,	V1 mV100	,	Reference resistance	KOHM OHM MOHM UOHM	Programs the measurement current.
RANGE	UOHM200 MOHM2 MOHM20 MOHM200 OHM2 OHM20 OHM200 KOHM2 KOHM20 KOHM200						Programs the specified range.
RANGE	MANUAL AUTO						Programs the autoranging.
MODE	PULSE ALTERNATE DIRECT		MAX AVR				Programs the current mode.
CYCLE	Number of meas.	,	Delay before 1st meas.	S	,	Interval between meas.	S Defines the measurement cycle (to be completed if required by TOC command).
TOC	Time of charge			S			Defines, for the OPER command, in direct current mode, the current time of charge before the first measurement.
OPER							Triggers a measurement cycle.
STBY							Standby.
CLAMP	OFF ON MV20 MV50						
ALARMS	OFF ON						
MEAS_REL	OFF DR DR R						
MEAS_RT	OFF ON	,	Memory register (0-9)				
MEAS_DT	OFF ON	,	Memory register (0-9)				

Table of unit specific commands (cont'd)

KEYB	OFF ON	Inhibits the keyboard keys, except OPER, STBY and CM.
LIGHT	OFF ON	Display lighting.
RPUL	ON OFF	Measuring cable resistance. <input type="text"/> , <input type="text"/> Length in meters <input type="text"/> , <input type="text"/> Number of wires

Preselection commands

LIM_1	HI LO	<input type="text"/> , <input type="text"/>	Limit of alarm 1	KOHM OHM MOHM UOHM	<input type="text"/> , <input type="text"/>	Hysteresis of alarm 1	KOHM OHM MOHM UOHM
LIM_2	HI LO	<input type="text"/> , <input type="text"/>	Limit of alarm 2	KOHM OHM MOHM UOHM	<input type="text"/> , <input type="text"/>	Hysteresis of alarm 2	KOHM OHM MOHM UOHM
REF_DR	FIXED MEAS	<input type="text"/> , <input type="text"/>	Resistance R0	KOHM OHM MOHM UOHM			
STORE RT	Memory register (0-9)	<input type="text"/> , <input type="text"/>	Resistance at 20°	KOHM OHM MOHM UOHM			
TEMP	FIXED MEAS	<input type="text"/> , <input type="text"/>	Ambient temperature Measurement interval	CEL S			
METAL	CU AL OTHER	<input type="text"/> , <input type="text"/>	Temperature coefficient	PCT			
OUT_ANA	Limit of 0 V output	<input type="text"/> , <input type="text"/>		KOHM OHM MOHM UOHM	<input type="text"/> , <input type="text"/>	Limit of 2.50 V output	KOHM OHM MOHM UOHM

Other commands

MEMORY	OFF ON
DEL_BURST	Burst number
DEL_MEMORY	
CL_ERR	