

# Thermowells and Fittings

- Threaded Regular
- Lagging Extensions
- Weld-in
- Flanged
- Protection Tubes
- Projectile
- Sanitary
- Test
- Vanstone
- Union Connection Fittings



**PALMER Wahl**

INSTRUMENTATION GROUP

*Continued Innovation since 1836*

*ISO9001:2008 CERTIFIED*

# Thermowell Selection and Ordering

# Thermowell Selection and Ordering

Palmer has manufactured thermowells since the 1940's, and has gained an expertise unsurpassed in the industry. Our machined wells are built in our factory for complete control of the production process. Our attention to detail allows us to

produce precision wells, allowing us to build to meet your needs and specifications. Thank you from all of us at Palmer Wahl for considering our products. We appreciate your business.



## How to Order Threaded and Regular Thermowells

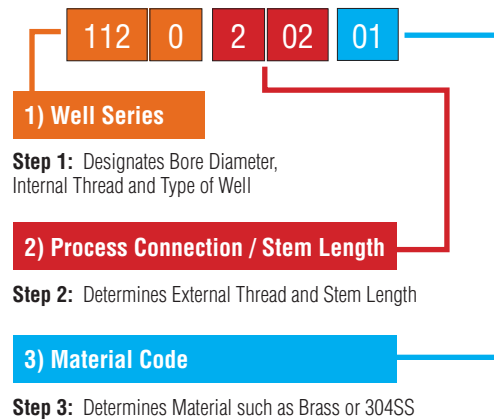

## How to Order Flanged Thermowells

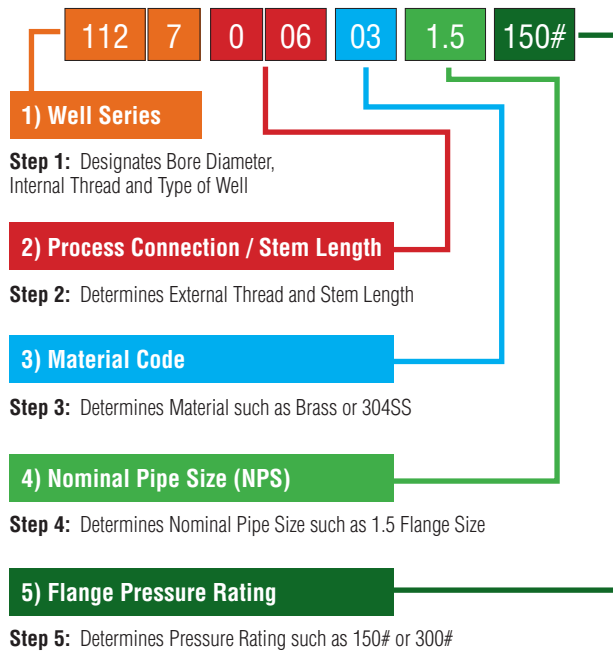

Material Codes			
Material	Code	Material	Code
Brass*+	01	Monel R-405	07
Carbon Steel C-108*	02	Hastelloy C	08
304SS*	03	Hastelloy B	09
304LSS*	04	Titanium	10
316SS*	05	Tantalum Sheath**	11
316LSS*	06		

\* Standard materials in stock. All other materials available upon request.  
 \*\* All wells with sheaths are continuous outside diameters, regardless of any steps shown on illustrations.  
 + Not available in Built-up wells.

## Page Selection

<b>Thermowell Material Selection Guide</b> .....	<b>3</b>
<b>112 Series Thermowells:</b> .260" Diameter Bore, 1/2"-14 NPS Internal Thread .....	<b>4</b>
<b>113 Series Thermowells:</b> .385" Diameter Bore, 1/2"-14 NPS Internal Thread, and 1/4"-18 NPT Internal Thread .....	<b>5</b>
<b>114 Series Thermowells:</b> .437" Diameter Tapered Bore, 1-1/4"-18 NEF Internal Thread.....	<b>6</b>
<b>115 Series Thermowells:</b> .501" Diameter Bore, 7/8"-22 NS Internal Thread.....	<b>7</b>
<b>116 Series Thermowells:</b> .437" Diameter Bore, 7/8"-22 NS Internal Thread.....	<b>8</b>
<b>Projectile Thermowells:</b> .437" Diameter Tapered Bore, 1-1/4"-18 NEF2 Internal Thread .....	<b>8</b>
<b>Sanitary Thermowells:</b> .260" Diameter Bore, 1/2"-14 NPT Internal Thread .....	<b>8</b>
<b>117 Series Test Thermowells:</b> .437" Diameter Bore, 1/2"-14 NPS Internal Thread, Protection Tubes: 1" Diameter Bore.....	<b>9</b>
<b>118 Series Vanstone &amp; Test Thermowells:</b> .260" Diameter Bore, .385" Diameter Bore, .437" Diameter Bore, 1/2"-14 NPS Internal Thread.....	<b>10</b>
<b>Union Connection Fittings: 112, 114 &amp; 115 Series:</b> Union, Flanged, Lagging and Flanged Lagging Connections .....	<b>11</b>



For information on Pressure-Temperature Ratings please see our website or call Customer Service

## Material Selection Guide

Corrodent	Temp. °F	Conc. %	Recommended Material
Acetic Acid	212	ALL	Monel
Acetic Anhydride	300		Nickel
Acetone	212	ALL	304SS
Acetylene	400		304SS
Alcohols	212	ALL	304SS
Alum (Potassium or Sodium)	300	ALL	Hast. C
Aluminum Chloride	212	ALL	Hast. B
Aluminum Sulfate	212	ALL	316SS
Ammonia, Dry	212	ALL	304, 316SS
Ammonium Hydroxide (Ammonia, Aqua)	212	ALL	304, 316SS
Ammonium Chloride	300	50%	Monel
Ammonium Nitrate	300	ALL	304SS
Ammonium Sulfate	212	ALL	316SS
Amyl Acetate	300	ALL	304SS
Aniline	25		Monel
Asphalt	250		304SS
Atmosphere (Industrial & Marine)			304SS
Barium Compounds	See Calcium		
Beer	70		304SS
Benzene (Benzol)	212		Steel
Benzoic Acid	212	ALL	316SS
Bleaching Powder	70	15%	Monel
Borax	212	ALL	Brass
Bordeaux Mixture	200		304SS
Boric Acid	400	ALL	316SS
Bromine	125	DRY	Monel
Butane	400	ALL	Steel
Butyl Alcohol	See Alcohols		
Butyric Acid	212		Hast. C
Calcium Bisulphite	75	ALL	Hast. C
Calcium Chloride	212	ALL	Hast. C
Calcium Hydroxide	300	20%	Hast. C
Calcium Hypochlorite	See Bleaching Powder		
Carbolic Acid	See Phenol		
Carbon Dioxide, Dry	800	ALL	Brass
Carbonated Water	212	ALL	304SS
Carbonated Beverages	212		304SS
Carbon Disulfide	200		304SS
Carbon Tetrachloride	125	ALL	Monel
Chlorine, Dry	100		Monel
Chlorine, Moist	100	ALL	Monel
Chloroacetic Acid	212	ALL	Monel
Chloroform, Dry	212		Monel
Chromic Acid	300	ALL	Hast. C
Cider	300	ALL	304SS
Citric Acid	212	ALL	Hast. C
Copper (10) Chloride	212	ALL	Hast. C
Copper (10) Nitrate	300	ALL	316SS
Copper (10) Sulfate	300	ALL	316SS
Copper Plating Solution (Cyanide)	180		304SS
Copper Plating Solution (Acid)	75		304SS
Corn Oil	200		304SS
Creosote	200	ALL	304SS
Crude Oil	300		Monel
Ethyl Acetate	See Lacquer Thinner		
Ethyl Chloride, Dry	500		Steel
Ethanol	See Alcohols		
Ethylene Glycol (Uninhibited)	212	ALL	304SS
Ethylene Oxide	75		Steel
Fatty Acids	500	ALL	316SS
Ferric Chloride	75	ALL	Hast. C
Ferric Sulfate	300	ALL	304SS
Formaldehyde	212	40%	316SS
Formic Acid	300	ALL	316SS
Freon	300		Steel
Fluorine, Anhydrous	100		304SS
Furfural	450		316SS
Gasoline	300		Steel
Glucose	300		304SS
Glue, ph 6-8	300	ALL	304SS
Glycerine	212	ALL	Brass
Hydrobromic Acid	212	ALL	Hast. C
Hydrochloric Acid (37-38%)	225	ALL	Hast. B
Hydrogen Chloride, Dry	500		304SS

Corrodent	Temp. °F	Conc. %	Recommended Material
Hydrocyanic Acid	212	ALL	304SS
Hydrofluoric Acid	212	60%	Monel
Hydrogen Fluoride, Dry	175		Steel
Hydrofluosilicic Acid	212	40%	Monel
Hydrogen Peroxide	125	10-100%	304SS
Kerosene	300	ALL	Steel
Lacquers & Thinners	300	ALL	304SS
Lactic Acid	300	ALL	316SS
Lime	212	ALL	316SS
Linseed Oil	75		Steel
Magnesium Chloride	212	50%	Nickel
Magnesium Hydroxide (or Oxide)	75	ALL	304SS
Magnesium Sulfate	212	40%	304SS
Mercuric Chloride	75	10%	Hast. C
Mercury	700	100%	Steel
Methylene Chloride	212	ALL	304SS
Methyl Chloride, Dry	75		Steel
Milk, fresh or sour	180		304SS
Molasses	See Glucose		
Natural Gas	70		304SS
Nitric Acid	75	ALL	304SS
Nitric Acid	300	ALL	316SS
Oxygen	75	ALL	Steel
Oleic Acid	See Fatty Acids		
Oxalic Acid	212	ALL	Monel
Photographic Bleaching	100	ALL	304SS
Palmitic Acid	See Fatty Acids		
Phosphoric Acid	212	ALL	316SS
Phenol	212	ALL	316SS
Potassium Compounds	See Sodium Compound		
Propane	300		Steel
Rosin	700	100%	316SS
Sea Water	75		Monel
Soap & Detergents	212	ALL	304SS
Sodium Bicarbonate	212	20%	316SS
Sodium Bisulfite	212	20%	304SS
Sodium Bisulfate	212	20%	304SS
Sodium Carbonate	212	40%	316SS
Sodium Chloride	300	30%	Monel
Sodium Chromate	212	ALL	316SS
Salt or Brine	See Sodium Chloride		
Sodium Cyanide	212	ALL	304SS
Sodium Hydroxide	212	30%	316SS
Sodium Hypochlorite	75	10%	Hast. C
Sodium Nitrate	212	40%	304SS
Sodium Nitrite	75	20%	316SS
Sodium Phosphate	212	10%	Steel
Sodium Silicate	212	10%	Steel
Sodium Sulfide	212	30%	316SS
Sodium Sulfite	212	10%	316SS
Sodium Sulfate	212	30%	304SS
Sodium Thiosulfate	212	ALL	304SS
Steam			304SS
Stearic Acid	See Fatty Acids		
Sugar Solution	See Glucose		
Sulfur	500		304SS
Sulfur Chloride	75	DRY	316SS
Sulfur Dioxide	500	DRY	316SS
Sulfur Trioxide	500	DRY	316SS
Sulfuric Acid	212	10%	316SS
Sulfuric Acid	212	10-90%	Hast. B
Sulfuric Acid	212	90-100%	Hast. B
Sulfuric Acid, Fuming	175		Hast. C
Sulfurous Acid	75	20%	316SS
Titanium Tetrachloride	75	ALL	316SS
Tannic Acid	75	40%	Hast. B
Toluene	75		Steel
Trichloroacetic Acid	75	ALL	Hast. B
Trichloroethylene	300	DRY	Monel
Turpentine	75		316SS
Varnish	150		Steel
Zinc Chloride	212	ALL	Hast. B
Zinc Sulfate	212	ALL	316SS

# 112 Series Thermowells

# 112 Series Thermowells

.260" Diameter Bore, 1/2"-14 NPS Internal Thread.

For use with Bimetals, 1035 & 1050 Dials, 81 Series Bulbs, #20 Gauge T/C Elements, and Digi-Stem 1/4" diameter with 1/2" NPT Probes.

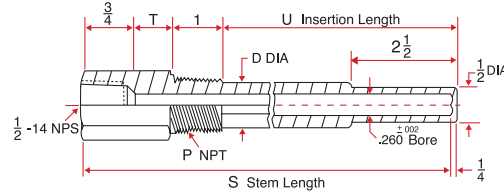
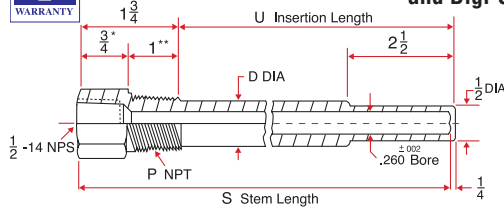

Threaded Regular: Series 1120				
"S" Stem Length	"U" Insertion Length	"P" NPT External Thread Size		
		1/2" - 14	3/4" - 14	1" - 11-1/2
2-1/2"	1-5/8"	1120-102 <sup>1</sup>	1120-202 <sup>1</sup>	1120-302 <sup>1</sup>
4"	2-1/2"	1120-104	1120-204	1120-304
6"	4-1/2"	1120-106	1120-206	1120-306
9"	7-1/2"	1120-109	1120-209	1120-309
12"	10-1/2"	1120-112	1120-212	1120-312
15"	13-1/2"	1120-115	1120-215	1120-315
18"	16-1/2"	1120-118	1120-218	1120-318
<b>"D" Diameter</b>		5/8"	3/4"	3/4"

Threaded Regular - Lagging Extension: Series 1121					
"S" Stem Length	"U" Insertion Length	"T" Lagging Extension	"P" NPT External Thread Size		
			1/2" - 14	3/4" - 14	1" - 11-1/2
6"	2-1/2"	2"	1121-106	1121-206	1121-306
9"	4-1/2"	3"	1121-109	1121-209	1121-309
12"	7-1/2"	3"	1121-112	1121-212	1121-312
15"	10-1/2"	3"	1121-115	1121-215	1121-315
18"	13-1/2"	3"	1121-118	1121-218	1121-318
<b>"D" Diameter</b>			5/8"	3/4"	3/4"

<sup>1</sup> \* 1" on the 1/2"-14 NPT External Thread      \*\* 3/4" on the 1/2"-14 NPT External Thread  
<sup>1</sup> Contact factory for prints on these series

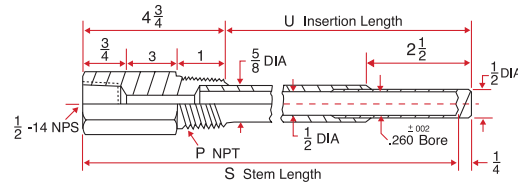
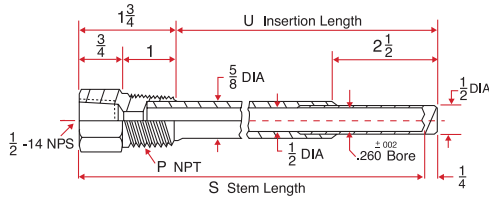

Built-Up Threaded Regular: Series 1124			
"S" Stem Length	"U" Insertion Length	"P" NPT External Thread Size	
		3/4" - 14	1" - 11-1/2
24"	22-1/2"	1124-224	1124-324
30"	28-1/2"	1124-230	1124-330
36"	34-1/2"	1124-236	1124-336
42"	40-1/2"	1124-242	1124-342
48"	46-1/2"	1124-248	1124-348

Built-Up Threaded Regular - Lagging Extension: Series 1125			
"S" Stem Length	"U" Insertion Length	"P" NPT External Thread Size	
		3/4" - 14	1" - 11-1/2
24"	19-1/2"	1125-224	1125-324
30"	25-1/2"	1125-230	1125-330
36"	31-1/2"	1125-236	1125-336
42"	37-1/2"	1125-242	1125-342
48"	43-1/2"	1125-248	1125-348

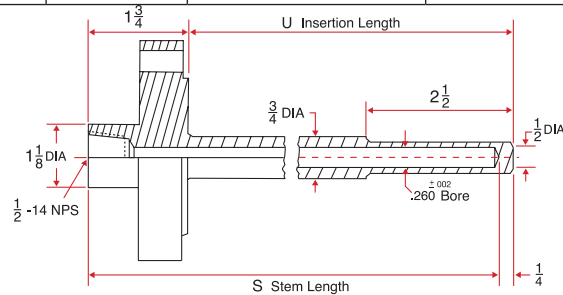
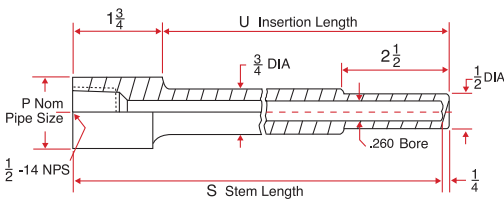

Flange thickness over 1", "U" - 1/2; over 1-1/2", "U" - 1"

Weld-In: Series 1126			
"S" Stem Length	"U" Insertion Length	"P" Nominal Pipe Size	
		3/4" - 1.050	1" - 1.315
4"	2-1/2"	1126-204	1126-304
6"	4-1/2"	1126-206	1126-306
9"	7-1/2"	1126-209	1126-309
12"	10-1/2"	1126-212	1126-312
15"	13-1/2"	1126-215	1126-315
18"	16-1/2"	1126-218	1126-318
24"	22-1/2"	1126-224	1126-324

Flanged: Series 1127		
"S" Stem Length	"U" Insertion Length	Type Number
4"	2-1/2"	1127-004
6"	4-1/2"	1127-006
9"	7-1/2"	1127-009
12"	10-1/2"	1127-012
15"	13-1/2"	1127-015
18"	16-1/2"	1127-018
24"	22-1/2"	1127-024



Specifications subject to change without notice. For Pressure Ratings see [www.palmerwahl.com/thermowells.php](http://www.palmerwahl.com/thermowells.php)

# 113 Series Thermowells

## 113 Series Thermowells

.385" Diameter Bore, 1/2"-14 NPS and 1/4"-18 NPT Internal Thread.

For use with #20 Gauge T/C Elements, and Digi-Stem 3/8" diameter with 1/2" NPT Probes.

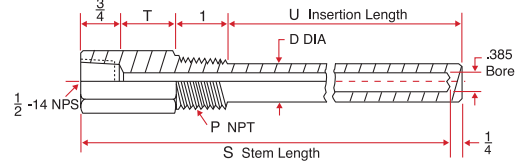
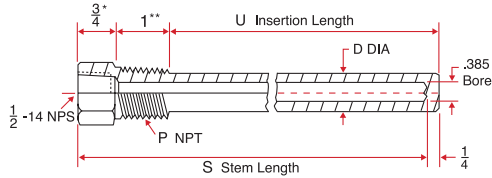

Threaded Regular: Series 1130				
"S" Stem Length	"U" Insertion Length	"P" NPT External Thread Size		
		1/2" - 14	3/4" - 14	1" - 11-1/2
2-1/2"	1-5/8"	1130-102 <sup>1</sup>	1130-202 <sup>1</sup>	1130-302 <sup>1</sup>
4"	2-1/2"	1130-104	1130-204	1130-304
6"	4-1/2"	1130-106	1130-206	1130-306
9"	7-1/2"	1130-109	1130-209	1130-309
12"	10-1/2"	1130-112	1130-212	1130-312
15"	13-1/2"	1130-115	1130-215	1130-315
18"	16-1/2"	1130-118	1130-218	1130-318
"D" Diameter		5/8"	3/4"	3/4"

Threaded Regular - Lagging Extension: Series 1131					
"S" Stem Length	"U" Insertion Length	"T" Lagging Extension	"P" NPT External Thread Size		
			1/2" - 14	3/4" - 14	1" - 11-1/2
6"	2-1/2"	2"	1131-106	1131-206	1131-306
9"	4-1/2"	3"	1131-109	1131-209	1131-309
12"	7-1/2"	3"	1131-112	1131-212	1131-312
15"	10-1/2"	3"	1131-115	1131-215	1131-315
18"	13-1/2"	3"	1131-118	1131-218	1131-318
"D" Diameter			5/8"	3/4"	3/4"

<sup>1</sup> 1" on the 1/2"-14 NPT External Thread      \*\* 3/4" on the 1/2"-14 NPT External Thread  
<sup>1</sup> Contact factory for prints on these series

Note: For Built-up Wells please contact factory

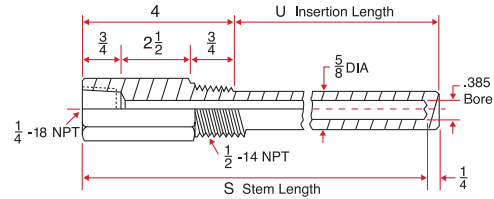
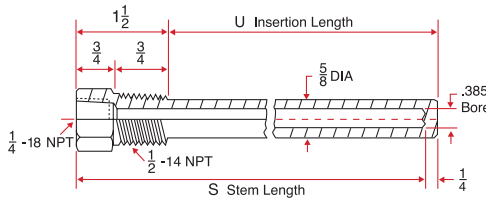

Threaded Regular 1/4"-18 Internal NPT: Series 1138		
"S" Stem Length	"U" Insertion Length	Type Number
3-1/4"	2"	1138-103
5-1/4"	4"	1138-105
7-1/4"	6"	1138-107
9-1/4"	8"	1138-109
11-1/4"	10"	1138-111
13-1/4"	12"	1138-113

Threaded Regular - Lagging Extension 1/4"-18 Internal NPT: Series 1139		
"S" Stem Length	"U" Insertion Length	Type Number
5-1/4"	1-1/2"	1139-105
7-1/4"	3-1/2"	1139-107
9-1/4"	5-1/2"	1139-109
11-1/4"	7-1/2"	1139-111
13-1/4"	9-1/2"	1139-113

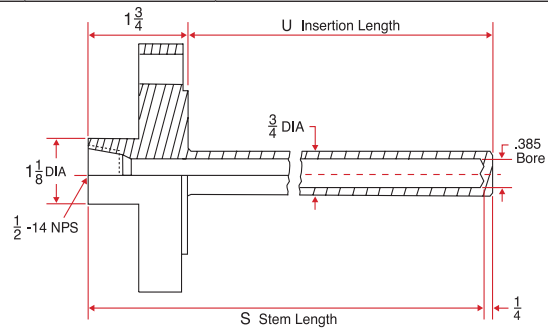
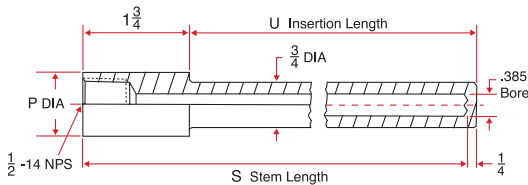

Flange thickness over 1", "U" - 1/2; 1-1/2", "U" - 1"

Weld-In: Series 1136			
"S" Stem Length	"U" Insertion Length	"P" Nominal Pipe Size	
		3/4" - 1.050	1" - 1.315
4"	2-1/2"	1136-204	1136-304
6"	4-1/2"	1136-206	1136-306
9"	7-1/2"	1136-209	1136-309
12"	10-1/2"	1136-212	1136-312
15"	13-1/2"	1136-215	1136-315
18"	16-1/2"	1136-218	1136-318
24"	22-1/2"	1136-224	1136-324

Flanged: Series 1137		
"S" Stem Length	"U" Insertion Length	Type Number
4"	2-1/2"	1137-004
6"	4-1/2"	1137-006
9"	7-1/2"	1137-009
12"	10-1/2"	1137-012
15"	13-1/2"	1137-015
18"	16-1/2"	1137-018
24"	22-1/2"	1137-024

Specifications subject to change without notice. For Pressure Ratings see [www.palmerwahl.com/thermowells.php](http://www.palmerwahl.com/thermowells.php)



# 114 Series Thermowells

# 114 Series Thermowells

.437" Diameter Tapered Bore, .180" Taper per foot, 1-1/4"-18 NEF Internal Thread.  
For use with Industrials, 35A/AL & 50A/AL Dials, & 51-13 Series Bulbs,  
and Digi-Stem 5/8" diameter with 1-1/4"-18 NEF. Wells for 3/4" diameter stems available.

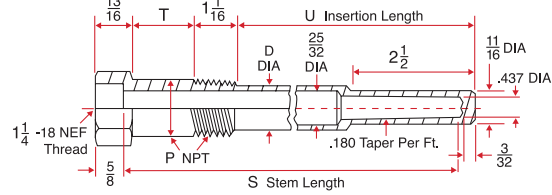
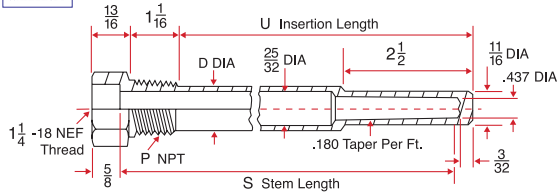

Threaded Regular with Tapered Bore: Series 1140			
"S" Stem Length	"U" Insertion Length	"P" NPT External Thread Size	
		3/4" - 14	1" - 11-1/2
3-1/2"	2-1/2"	<b>1140-203</b>	<b>1140-303</b>
6"	5"	<b>1140-206</b>	<b>1140-306</b>
8"	7"	<b>1140-208</b>	<b>1140-308</b>
9"	8"	<b>1140-209</b>	<b>1140-309</b>
12"	11"	<b>1140-212</b>	<b>1140-312</b>
18"	17"	<b>1140-218</b>	<b>1140-318</b>
<b>"D" Diameter</b>		7/8"	1-1/16"

Threaded Regular with Tapered Bore - Lagging Extension: Series 1141				
"S" Stem Length	"U" Insertion Length	"T" Lagging Extension	"P" NPT External Thread Size	
			3/4" - 14	1" - 11-1/2
6"	2-1/2"	2-1/2"	<b>1141-206</b>	<b>1141-306</b>
8"	4"	3"	<b>1141-208</b>	<b>1141-308</b>
9"	5"	3"	<b>1141-209</b>	<b>1141-309</b>
12"	8"	3"	<b>1141-212</b>	<b>1141-312</b>
18"	14"	3"	<b>1141-218</b>	<b>1141-318</b>
<b>"D" Diameter</b>			7/8"	1-1/16"
<b>"P" Diameter</b>			1.05	1.315

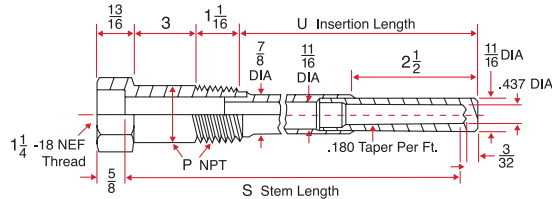
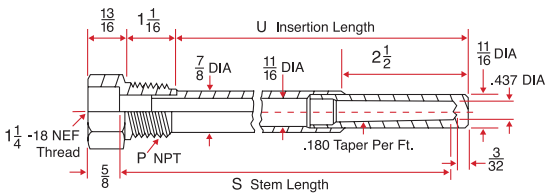

Built-Up Threaded Regular with Tapered Bore: Series 1144			
"S" Stem Length	"U" Insertion Length	"P" NPT External Thread Size	
		3/4" - 14	1" - 11-1/2
24"	23"	<b>1144-224</b>	<b>1144-324</b>
30"	29"	<b>1144-230</b>	<b>1144-330</b>
36"	35"	<b>1144-236</b>	<b>1144-336</b>
42"	41"	<b>1144-242</b>	<b>1144-342</b>
48"	47"	<b>1144-248</b>	<b>1144-348</b>
<b>"P" Diameter</b>		1.05	1.315

Built-Up Threaded Regular with Tapered Bore - Lagging Extension: Series 1145			
"S" Stem Length	"U" Insertion Length	"P" NPT External Thread Size	
		3/4" - 14	1" - 11-1/2
24"	20"	<b>1145-224</b>	<b>1145-324</b>
30"	26"	<b>1145-230</b>	<b>1145-330</b>
36"	32"	<b>1145-236</b>	<b>1145-336</b>
42"	38"	<b>1145-242</b>	<b>1145-342</b>
48"	44"	<b>1145-248</b>	<b>1145-348</b>
<b>"P" Diameter</b>		1.05	1.315

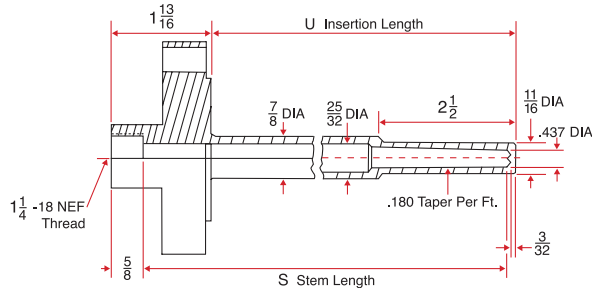
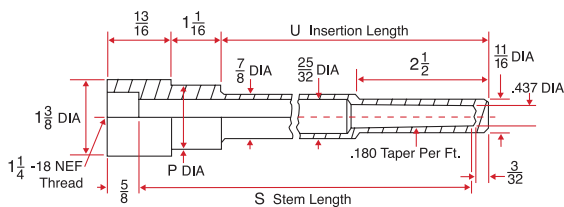

Weld-In with Tapered Bore: Series 1146			
"S" Stem Length	"U" Insertion Length	"P" Nominal Pipe Size	
		3/4" - 1.050	1" - 1.315
3-1/2"	2-1/2"	<b>1146-203</b>	<b>1146-303</b>
6"	5"	<b>1146-206</b>	<b>1146-306</b>
8"	7"	<b>1146-208</b>	<b>1146-308</b>
9"	8"	<b>1146-209</b>	<b>1146-309</b>
12"	11"	<b>1146-212</b>	<b>1146-312</b>
18"	17"	<b>1146-218</b>	<b>1146-318</b>
24"	23"	<b>1146-224</b>	<b>1146-324</b>

Flanged with Tapered Bore: Series 1147		
"S" Stem Length	"U" Insertion Length	Type Number
3-1/2"	2-1/2"	<b>1147-003</b>
6"	5"	<b>1147-006</b>
8"	7"	<b>1147-008</b>
9"	8"	<b>1147-009</b>
12"	11"	<b>1147-012</b>
18"	17"	<b>1147-018</b>
24"	23"	<b>1147-024</b>

Flange thickness over 1", "U" - 1/2; over 1-1/2", "U" - 1"



Specifications subject to change without notice. For Pressure Ratings see [www.palmerwahl.com/thermowells.php](http://www.palmerwahl.com/thermowells.php)

# 115 Series Thermowells

## 115 Series Thermowells

.501" Diameter Bore, 7/8"-22 NS Internal Thread.  
For use with #20 Gauge T/C Elements.

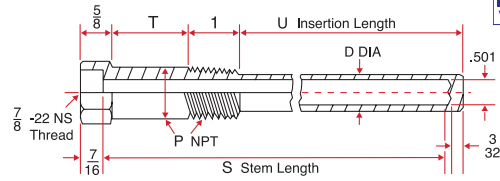
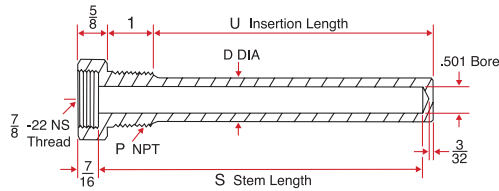

Threaded Regular: Series 1150				
"S" Stem Length	"U" Insertion Length	"P" NPT External Thread Size		
		1/2" - 14	3/4" - 14	1" - 11-1/2
4"	3-1/16"	<b>1150-104</b>	<b>1150-204</b>	<b>1150-304</b>
6"	5-1/16"	<b>1150-106</b>	<b>1150-206</b>	<b>1150-306</b>
8"	7-1/16"	<b>1150-108</b>	<b>1150-208</b>	<b>1150-308</b>
12"	11-1/16"	<b>1150-112</b>	<b>1150-212</b>	<b>1150-312</b>
18"	17-1/16"	<b>1150-118</b>	<b>1150-218</b>	<b>1150-318</b>
<b>"D" Diameter</b>		11/16"	3/4"	3/4"

Threaded Regular - Lagging Extension: Series 1151					
"S" Stem Length	"U" Insertion Length	"T" Lagging Extension	"P" NPT External Thread Size		
			1/2" - 14	3/4" - 14	1" - 11-1/2
6"	3-1/16"	2"	<b>1151-106</b>	<b>1151-206</b>	<b>1151-306</b>
8"	4-1/16"	3"	<b>1151-108</b>	<b>1151-208</b>	<b>1151-308</b>
12"	8-1/16"	3"	<b>1151-112</b>	<b>1151-212</b>	<b>1151-312</b>
18"	14-1/16"	3"	<b>1151-118</b>	<b>1151-218</b>	<b>1151-318</b>
<b>"D" Diameter</b>			11/16"	3/4"	3/4"
<b>"P" Diameter</b>			.840	1.05	1.315

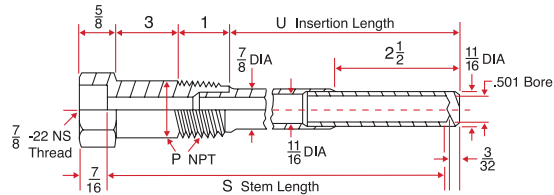
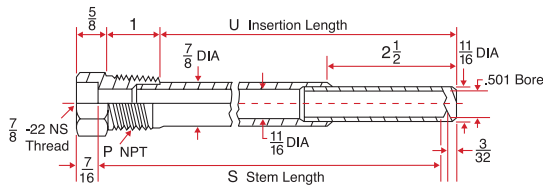

Built-Up Threaded Regular: Series 1154			
"S" Stem Length	"U" Insertion Length	"P" NPT External Thread Size	
		3/4" - 14	1" - 11-1/2
24"	23-1/16"	<b>1154-224</b>	<b>1154-324</b>
30"	29-1/16"	<b>1154-230</b>	<b>1154-330</b>
36"	35-1/16"	<b>1154-236</b>	<b>1154-336</b>
42"	41-1/16"	<b>1154-242</b>	<b>1154-342</b>
48"	47-1/16"	<b>1154-248</b>	<b>1154-348</b>

Built-Up Threaded Regular - Lagging Extension: Series 1155			
"S" Stem Length	"U" Insertion Length	"P" NPT External Thread Size	
		3/4" - 14	1" - 11-1/2
24"	20-1/2"	<b>1155-224</b>	<b>1155-324</b>
30"	26-1/2"	<b>1155-230</b>	<b>1155-330</b>
36"	32-1/2"	<b>1155-236</b>	<b>1155-336</b>
42"	38-1/2"	<b>1155-242</b>	<b>1155-342</b>
48"	44-1/2"	<b>1155-248</b>	<b>1155-348</b>
<b>"P" Diameter</b>		1.05	1.315

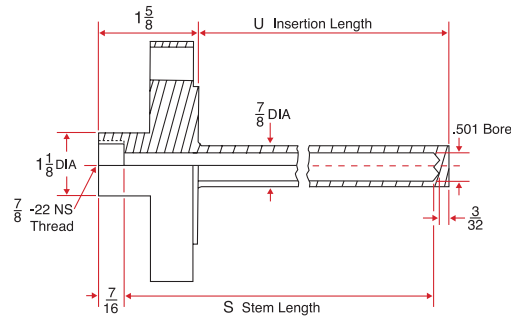
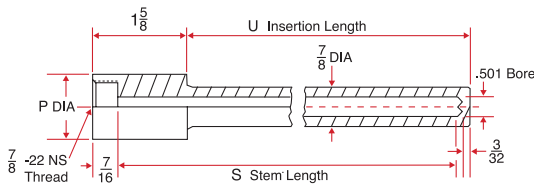

Flange thickness over 1", "U" - 1/2; over 1-1/2", "U" - 1"

Weld-In: Series 1156			
"S" Stem Length	"U" Insertion Length	"P" Nominal Pipe Size	
		3/4" - 1.050	1" - 1.315
4"	3-1/16"	<b>1156-204</b>	<b>1156-304</b>
6"	5-1/16"	<b>1156-206</b>	<b>1156-306</b>
8"	7-1/16"	<b>1156-208</b>	<b>1156-308</b>
12"	11-1/16"	<b>1156-212</b>	<b>1156-312</b>
18"	17-1/16"	<b>1156-218</b>	<b>1156-318</b>
24"	23-1/16"	<b>1156-224</b>	<b>1156-324</b>

Flanged: Series 1157		
"S" Stem Length	"U" Insertion Length	Type Number
4"	3-1/16"	<b>1157-004</b>
6"	5-1/16"	<b>1157-006</b>
8"	7-1/16"	<b>1157-008</b>
12"	11-1/16"	<b>1157-012</b>
18"	17-1/16"	<b>1157-018</b>
24"	23-1/16"	<b>1157-024</b>

Specifications subject to change without notice. For Pressure Ratings see [www.palmerwahl.com/thermowells.php](http://www.palmerwahl.com/thermowells.php)



# 116 Series Projectile & Sanitary Thermowells



## 116 Series Thermowells

.437" Diameter Bore, 7/8"-22 NS Internal Thread. For use with Palmer 7AA Industrials.

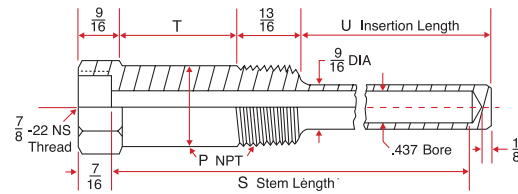
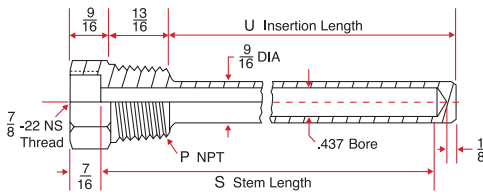

Threaded Regular: Series 1160			
"S" Stem Length	"U" Insertion Length	"P" NPT External Thread Size	
		1/2" - 14	3/4" - 14
2-1/4"	1-1/2"	<b>1160-102</b>	<b>1160-202</b>
3-3/4"	3"	<b>1160-103</b>	<b>1160-203</b>
4-3/4"	4"	<b>1160-104</b>	<b>1160-204</b>
6"	5-1/4"	<b>1160-106</b>	<b>1160-206</b>

Threaded Regular - Lagging Extension: Series 1161				
"S" Stem Length	"U" Insertion Length	"T" Lagging Extension	"P" NPT External Thread Size	
			1/2" - 14	3/4" - 14
3-3/4"	2"	1"	<b>1161-103</b>	<b>1161-203</b>
4-3/4"	2-1/2"	1-1/2"	<b>1161-104</b>	<b>1161-204</b>
6"	3-1/4"	2"	<b>1161-106</b>	<b>1161-206</b>
"P" Diameter			.840	1.05

## Projectile Thermowells

.437" Diameter Tapered Bore, .180" Taper per foot, 1-1/4"-18 NEF2 Internal Thread. For use with Industrials and Cleanliner Thermometers, and Digi-Stem 5/8" diameter with 1-1/4"-18 NEF.

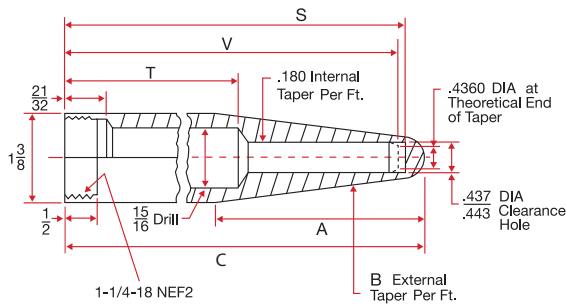

Projectile Wells: Series 26P							
Model Number	Stem Length	"A" External Taper Length	"B" Taper Per Foot	"C" Overall Length	"S" Stem Length	"T" Clearance Hole	"V" Theoretical End of Taper
26P397	9-1/8"	3-1/4"	3.062"	10-1/8"	9-49/64"	7-3/16"	9-21/32"
26P398	12-1/8"	3-3/4"	2.625"	13-1/8"	12-49/64"	10-3/16"	12-21/32"

## Sanitary Thermowells

.260" Diameter Bore, 1/2"-14 NPT Internal Thread. For use with All Sanitary Thermometers.

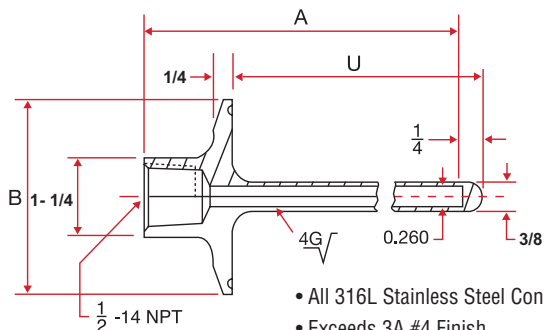

- All 316L Stainless Steel Construction
- Exceeds 3A #4 Finish
- Fast Installation & Removal from Process
- Food Processing
- Beverage Industry
- Pharmaceutical Processing



Sanitary Wells: Series 1128				
Tri-Clamp Size	"A" Stem Length	Part Number	"U" Insertion Length	"B" Flange Diameter
1-1/2"	2-1/2"	<b>1128-152-05</b>	1-5/8"	1.984"
	4"	<b>1128-154-05</b>	2-1/2"	
	6"	<b>1128-156-05</b>	4-1/2"	
	9"	<b>1128-159-05</b>	7-1/2"	
2.0"	2-1/2"	<b>1128-202-05</b>	1-5/8"	2.516"
	4"	<b>1128-204-05</b>	2-1/2"	
	6"	<b>1128-206-05</b>	4-1/2"	
	9"	<b>1128-209-05</b>	7-1/2"	
2-1/2"	2-1/2"	<b>1128-252-05</b>	1-5/8"	3.047"
	4"	<b>1128-254-05</b>	2-1/2"	
	6"	<b>1128-256-05</b>	4-1/2"	
	9"	<b>1128-259-05</b>	7-1/2"	
3.0"	2-1/2"	<b>1128-302-05</b>	1-5/8"	3.579"
	4"	<b>1128-304-05</b>	2-1/2"	
	6"	<b>1128-306-05</b>	4-1/2"	
	9"	<b>1128-309-05</b>	7-1/2"	



Specifications subject to change without notice. For Pressure Ratings see [www.palmerwahl.com/thermowells.php](http://www.palmerwahl.com/thermowells.php)



# 117 Series Test Thermowells & Protection Tubes

## 117 Series Test Thermowells

.437" Diameter Bore, 1/2"-14 NPS Internal Thread.  
For use with #20 Gauge T/C Elements.

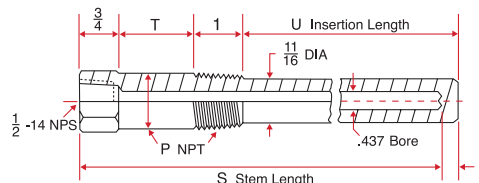
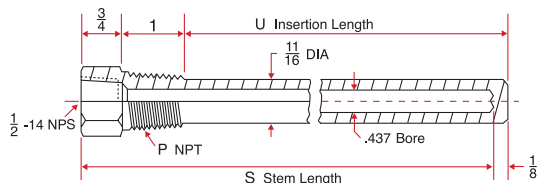

Threaded Regular: Series 1170				
"S" Stem Length	"U" Insertion Length	"P" NPT External Thread Size		
		1/2" - 14	3/4" - 14	1" - 11-1/2
4"	2-1/2"	1170-104	1170-204	1170-304
6"	4-1/2"	1170-106	1170-206	1170-306
9"	7-1/2"	1170-109	1170-209	1170-309
12"	10-1/2"	1170-112	1170-212	1170-312
15"	13-1/2"	1170-115	1170-215	1170-315
18"	16-1/2"	1170-118	1170-218	1170-318
24"	22-1/2"	1170-124	1170-224	1170-324

Threaded Regular - Lagging Extension: Series 1171					
"S" Stem Length	"U" Insertion Length	"T" Lagging Extension	"P" NPT External Thread Size		
			1/2" - 14	3/4" - 14	1" - 11-1/2
6"	2-1/2"	2"	1171-106	1171-206	1171-306
9"	4-1/2"	3"	1171-109	1171-209	1171-309
12"	7-1/2"	3"	1171-112	1171-212	1171-312
15"	10-1/2"	3"	1171-115	1171-215	1171-315
18"	13-1/2"	3"	1171-118	1171-218	1171-318
24"	19-1/2"	3"	1171-124	1171-224	1171-324

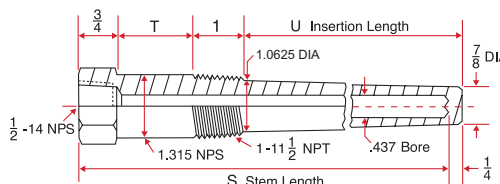
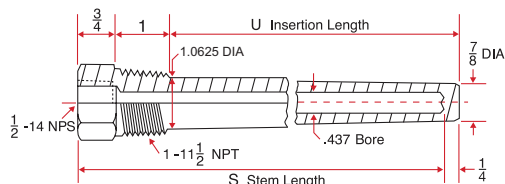

Heavy Wall Regular: Series 1172		
"S" Stem Length	"U" Insertion Length	Type Number
4"	2-1/2"	1172-304
6"	4-1/2"	1172-306
9"	7-1/2"	1172-309
12"	10-1/2"	1172-312
15"	13-1/2"	1172-315
18"	16-1/2"	1172-318
24"	22-1/2"	1172-324

Heavy Wall - Lagging Extension: Series 1173			
"S" Stem Length	"U" Insertion Length	"T" Lagging Extension	Type Number
6"	2-1/2"	2"	1173-306
9"	4-1/2"	3"	1173-309
12"	7-1/2"	3"	1173-312
15"	10-1/2"	3"	1173-315
18"	13-1/2"	3"	1173-318
24"	19-1/2"	3"	1173-324

## 117 Series Protection Tubes

Protection Tubes: 1" Diameter Bore  
For use with Palmer Bimetals, 1035 & 1050 Dials,  
81 Series Bulbs, #20 Gauge T/C Elements.

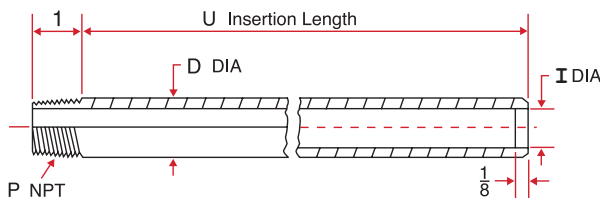

Protection Tubes: Series 1178				
"U" Insertion Length	Schedule Wall Thickness	"P" NPT External Thread Size		
		1/2"-14	3/4" - 14	1" - 11-1/2
4"	40	1178-104	1178-204	1178-304
6"	40	1178-106	1178-206	1178-306
8"	40	1178-108	1178-208	1178-308
10"	40	1178-110	1178-210	1178-310
12"	40	1178-112	1178-212	1178-312
"D" Dia		.840	1.050	1.315
"I" Dia		.622	.824	1.049

Protection Tubes: Series 1179				
"U" Insertion Length	Schedule Wall Thickness	"P" NPT External Thread Size		
		1/2"-14	3/4" - 14	1" - 11-1/2
4"	80	1179-104	1179-204	1179-304
6"	80	1179-106	1179-206	1179-306
8"	80	1179-108	1179-208	1179-308
10"	80	1179-110	1179-210	1179-310
12"	80	1179-112	1179-212	1179-312
"D" Dia		.840	1.050	1.315
"I" Dia		.546	.742	.957

Specifications subject to change without notice. For Pressure Ratings see [www.palmerwahl.com/thermowells.php](http://www.palmerwahl.com/thermowells.php)



# 118 Series Vanstone & Test Thermowells



## 118 Vanstone & Test Thermowells

.260", .385", .437" Diameter Bore, 1/2"-14 NPS Internal Thread.

For use with: Digi-Stem 1/4" diameter with 1/2" NPT, (1181 Series) and 3/8" diameter with 1/2" NPT Probes (1182 Series).

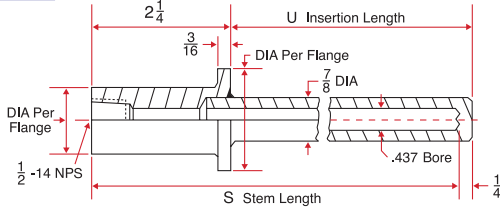

Vanstone: Series 1180		
"S" Stem Length	"U" Insertion Length	Type Number
4"	2"	1180-004
6"	4"	1180-006
9"	7"	1180-009
12"	10"	1180-012
15"	13"	1180-015
18"	16"	1180-018
24"	22"	1180-024

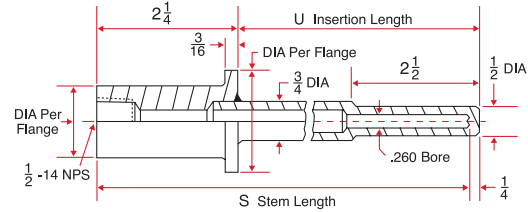

Vanstone: Series 1181		
"S" Stem Length	"U" Insertion Length	Type Number
4"	2"	1181-004
6"	4"	1181-006
9"	7"	1181-009
12"	10"	1181-012
15"	13"	1181-015
18"	16"	1181-018
24"	22"	1181-024

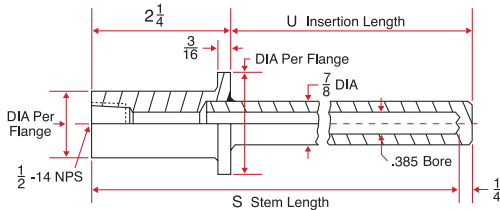

Vanstone: Series 1182		
"S" Stem Length	"U" Insertion Length	Type Number
4"	2"	1182-004
6"	4"	1182-006
9"	7"	1182-009
12"	10"	1182-012
15"	13"	1182-015
18"	16"	1182-018
24"	22"	1182-024

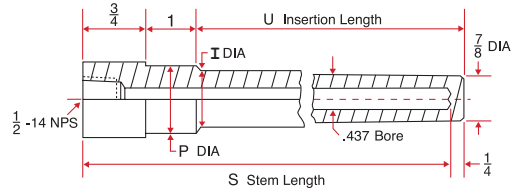

Heavy Wall Weld-In: Series 1183			
"S" Stem Length	"U" Insertion Length	"P" Diameter Nominal Pipe Size	
		3/4" - 1.050	1" - 1.315
6"	4-1/2"	1183-206	1183-306
9"	7-1/2"	1183-209	1183-309
12"	10-1/2"	1183-212	1183-312
15"	13-1/2"	1183-215	1183-315
18"	16-1/2"	1183-218	1183-318
24"	22-1/2"	1183-224	1183-324
"I" Dia		1"	1.065"

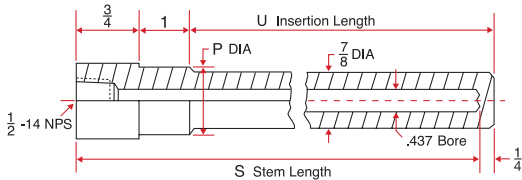

Weld-In: Series 1186			
"S" Stem Length	"U" Insertion Length	"P" Nominal Pipe Size	
		3/4" - 1.050	1" - 1.315
4"	2-1/2"	1186-204	1186-304
6"	4-1/2"	1186-206	1186-306
9"	7-1/2"	1186-209	1186-309
12"	10-1/2"	1186-212	1186-312
15"	13-1/2"	1186-215	1186-315
18"	16-1/2"	1186-218	1186-318
24"	22-1/2"	1186-224	1186-324

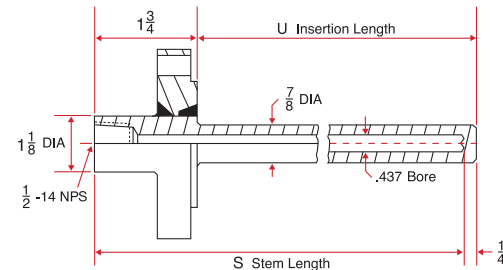

Flanged: Series 1187		
"S" Stem Length	"U" Insertion Length	Type Number
4"	2-1/2"	1187-004
6"	4-1/2"	1187-006
9"	7-1/2"	1187-009
12"	10-1/2"	1187-012
15"	13-1/2"	1187-015
18"	16-1/2"	1187-018
24"	22-1/2"	1187-024

Flange thickness over 1", "U" - 1/2; over 1-1/2", "U" - 1"



Specifications subject to change without notice. For Pressure Ratings see [www.palmerwahl.com/thermowells.php](http://www.palmerwahl.com/thermowells.php)

# Union Connection Fittings Series 112, 114 & 115

## Union Connections

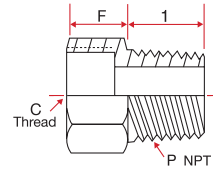
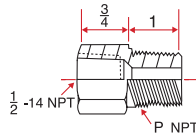

Union Connections	
"P" NPT	Type Number
3/4" - 14	1120-7
1" - 11-1/2	1120-8

Union Connections		
"P" NPT	"C" Thread	
	7/8-22NS	1-1/4" - 18 NEF
3/4"-14 1"-11-1/2	1150-7 1150-8	1140-7 1140-8
"F" DIM	9/16"	13/16"

## Flanged Union Connections

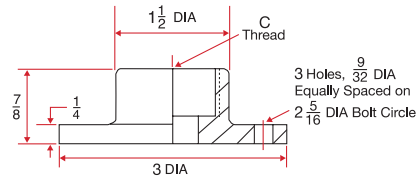
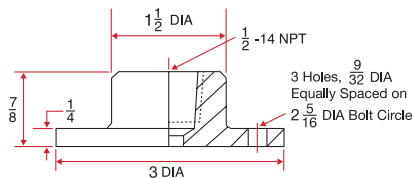

Flanged Unions	
"P" NPT	Type Number
1/2" - 14	1120-9

Flanged Unions	
"C" Thread	
7/8-22NS	1-1/4" - 18 NEF
1150-9	1140-9

## Lagging Union Connections

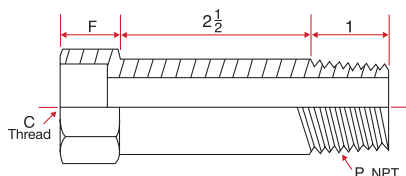

## Flanged Lagging Union Connections

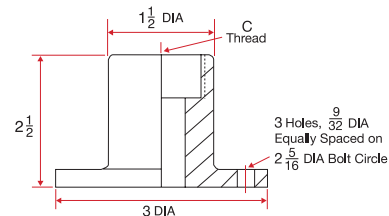

Lagging Union Connections			
"P" NPT	"C" Thread		
	7/8-22NS	1-1/4" - 18 NEF	1/2"-14 NPS
3/4"-14 1"-11-1/2	1151-7 1151-8	1141-7 1141-8	1121-7 1121-8
"F" DIM	9/16"	13/16"	3/4"

Flanged Lagging Union Connections	
"C" Thread	
7/8-22NS	1-1/4" - 18 NEF
1151-9	1141-9

1121-9 - has been discontinued

### Testing Services for Thermowells

- Certified Drawings
- Full Penetration Flanged Wells
- Teflon Coated Wells (limit to 12")
- X-ray of Well
- Dye Penetrant Test
- Mill Test Report (Material Certificate) (at time of order)
- Hydrostatic Internal Test (including Certificate)

Specifications subject to change without notice. For Pressure Ratings see [www.palmerwahl.com/thermowells.php](http://www.palmerwahl.com/thermowells.php)





America's First Manufacturer of Precision Industrial Temperature and Pressure Instrumentation

Wahl Designs and manufacturers to the most stringent quality standards. We provide certified, traceable calibration data in support of companies whose requirements include meeting ISO 9001:2008, FAA and FDA quality standards. Calibrations to both IPTS-68 and ITS-90 are available.

CALIBRATION SERVICES

STANDARD CERTIFICATION: Unit is calibrated to factory specifications using NIST traceable equipment. Unit is provided with:

Certificate of Conformance - Statement that our product meets published specifications. Included on the packing list with each shipment.

"Long Form" Certificate of Conformance - Available upon request, includes Certificate of conformance with customer's PO number, items shipped, and any product serial numbers for products included in the shipment.

Calibration Sticker - (or tag) Advising you of the date your instrument(s) was/were calibrated, and the suggested date for the next calibration. This is provided with most products at time of purchase, and when you return a product for calibration.

NIST TRACEABLE TEST REPORT: Unit is calibrated to factory specifications using NIST Traceable equipment. Provides instrument test data with details of standard instruments used to perform the calibration.



"As Received" and "As Left" Test Data are provided, as appropriate, with and out of tolerance conditions noted, and a unique test number assigned.

NIST Traceable Test Report - provides the date your instrument(s) was/were calibrated, technician performing the calibration, suggested date for the next calibration, and references the unique test number shown in the Test Report. Our Quality Management System is certified to conform to ISO9001:2008. We maintain a calibration system in conformance with ANSI/NCSL Z-540 and MIL-STD-45662A.

REPAIR AND OTHER SERVICES

REGISTER YOUR PRODUCT: Registration is fast and easy. In about a minute you can register your product for Warranty Protection and our Calibration Reminder Service to keep your QC Program in compliance. Go to: www.palmerwahl.com/register

REPAIR and OTHER SERVICES: Palmer Wahl offers repair and calibration services on most products we sell. The customer will receive a written estimate for approval before proceeding with work. Repair pricing includes Standard Certification as listed above.

Detailed Repair Report - Available upon request, this report provides details of evaluation and repairs made.

Custom Points - Palmer Wahl will calibrate your instruments at your specified temperature or pressure points..

Special Requests - When calibrating your instrument, our experienced personnel will help you to achieve the level of quality you require in your facility.

Note: Before returning your product to us, please contact us to obtain a Return Merchandise Authorization Number (RMA). Call Customer Service at 1-800-421-2853 or go to www.palmerwahl.com and click on: Service > Product Return Request.

Palmer Thermowells are available from:

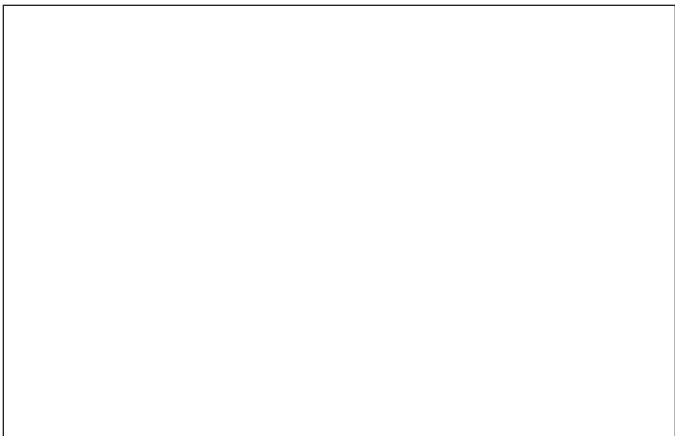

Palmer Wahl Warranty

Manufacturer warrants all products listed in this catalog to be free from defects in material or workmanship under normal use and service. The Manufacturer agrees to repair or replace any product which upon examination is revealed to have been defective due to faulty workmanship or material if returned to our factory, transportation charges prepaid, within the product specific warranty period stated in the catalog by the manufacturer. This warranty is in lieu of all other warranties, expressed or implied and of all obligations or liabilities on its part for damages including but not limited to consequential damages, following the use or misuse of instruments sold by the Manufacturer. No agent is authorized to assume for manufacturer any liability except as set forth above.

Why You Need to Calibrate your Instruments

- Increase customer satisfaction with consistent products.
• Comply with quality standards.
• Improve product quality.
• Ensure traceability throughout your entire manufacturing process.
• Palmer Wahl can calibrate your equipment for you. We also offer a complete line of Calibrators to integrate all the necessary functions for adjustment and maintenance of your process.
• We make it easy to use our products and services, and Palmer Wahl is there to help every step of the way.



234 Old Weaverville Road • Asheville, North Carolina • 28804-1260
Phone: 800-421-2853 • 828-658-3131 • Fax: 828-658-0728 • Email: info@palmerwahl.com
www.palmerwahl.com

PW1100 Specifications Catalog 04/11 Rev A Revised 02/23/15