

Technical Datasheet



Sentry Series Pressure Switch

Models: P01, P02 & P03

Key Features

- SPDT & DPDT Switch Outputs
- Aluminium Epoxy Coated Weatherproof Enclosure IP66/NEMA4X
- ATEX / IECEx Intrinsically Safe option
- 316 Stainless Steel Wetted Parts as Standard.
- Field Adjustable Set-points Against a Reference Scale
- Pressure Ranges up to 700bar (10,000psi)
- Maximum Working Pressure up to 1000bar (15,000psi)
- Safety Vented Design as Standard
- Suitable for use in SIL 2 safety related systems

Series Overview

The Sentry Series offers exceptional performance and high build quality in a simple, safe and cost-effective package.

- Performance is assured by repackaging Delta's well proven sensor technologies in a new, simple, one-piece enclosure.
- Commissioning is made simple by the inclusion of a hinged lid that is held in place by a single captive screw.
- Safety is maintained by a vent that prevents the enclosure becoming pressurized in the event of a sensor being damaged.
- Cost is minimised through the selection of common standard options although, as with all Delta products, a variety of optional extras are available to tailor the product to specific needs.

Other products in the series include:

- Differential Pressure Switches: Model D0
- Temperature Switches: Model T0



Product applications

The Sentry Series is suitable for a wide range of applications in:

- Process plants
- OEM equipment

The choice of models available ensures that the Sentry Series is suitable for use in:

- General purpose applications
- Zone 0 Hazardous Areas
- SIL 2 safety related systems

How can we help you?

Delta Controls' offers fast, efficient and knowledgeable support when and where you need it. Please visit our web site at www.delta-controls.com to find your local support centre or call us on:

+44 (0) 1252 729 140

Sentry Series
Models: P01, P02 & P03

How to order

Switches can be configured by selecting codes representing the desired features from the tables that follow. The chart below, describes how the model code is built up. For assistance in configuring a switch that best suits your needs, please contact your local sales office.

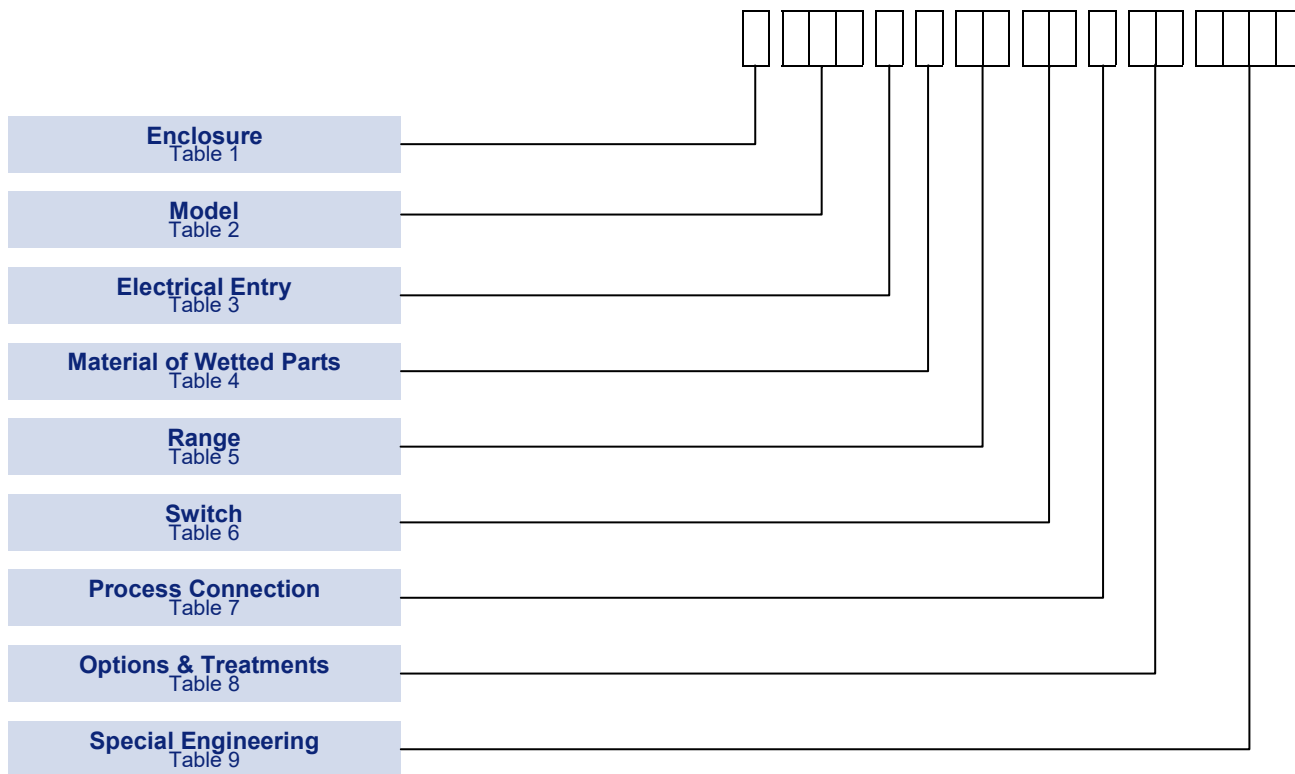

NOTE: Options shaded in the following tables are the most common options and are available on the quickest lead-times and at the lowest cost.

NOTE: Only the most common options are shown in this data sheet. Should you require a feature that is not shown, please contact your local sales office for further details.

Technical Specification

Sentry Series Models: P01, P02 & P03	Accuracy:	Set point repeatability $\pm 1\%$ of span at 20°C / 68°F ambient.
	Storage Temperature:	-40 to +60°C / -40 to +140°F
	Ambient Temperature:	-30 to +60°C / -22 to +140°F
	Maximum Process Temperature:	Subject to appropriate installation practice, the component parts withstand up to +60°C (+140°F). For process temperatures up to +120°C (+248°F), order WETTED PARTS Code A or S (Table 4). For higher temperatures, refer to SPECIAL ENGINEERING.
	Enclosure classification:	IP66 / NEMA 4X / Intrinsically Safe Ex ia
	Switch output:	SPDT or DPDT snap action microswitch (standard) Hermetically sealed (optional)
	Electrical rating:	See Table 6
	Process Connection:	1/4" NPT F (standard) Others (optional)
	Approximate Weight:	0.7kg (1.5lb) approx.

Enclosure

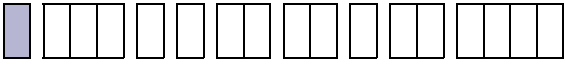
TABLE 1 

WEATHERPROOF ENCLOSURE	Code
General Purpose The basic enclosure is die-cast in aluminium, epoxy painted, with weather protection not less than NEMA type 4X, IP66.	W
Intrinsic Safety: Ex ia As per General Purpose enclosure above but ATEX and IECEx approved for use in Zone 0 hazardous locations.  II 1GD Ex ia IIC T5 / T6 Ga (-60°C≤Ta≤+80°C) / (-25°C≤Ta≤+60°C) Ex ia IIIC T135°C Da (-60°C≤Ta≤+80°C)	5

Models

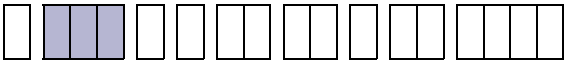
TABLE 2 

- P01**
For applications up to 1.5 bar (20 psi), maximum working pressure 15 bar (217 psi).
- P02**
For applications up to 100 bar (1500 psi), maximum working pressure 155 bar (2250 psi).
- P03**
For applications up to 700 bar (10,000 psi), maximum working pressure 1000 bar (15,000 psi).

		Code
Pressure	Diaphragm Operated Low Overload Pressure	P01
Pressure	Diaphragm Operated Standard Pressure	P02
Pressure	Diaphragm Operated High Overload Pressure	P03

Electrical Entry

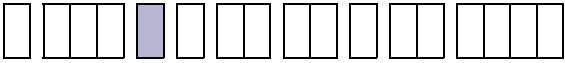
TABLE 3 

Description	Code
M20 x 1.5 Internal ISO Thread	0
½ NPT Internal Thread	2

Material of Wetted Parts

For reduced risk against leakage under extreme or unusual conditions the diaphragm may be welded directly to the process connection, eliminating the O-ring (Code S).

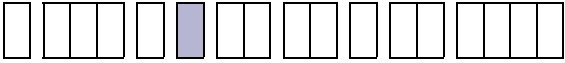
TABLE 4 

	Code
316 Stainless steel diaphragm and process connection Viton O-ring seal.	A
316 Stainless steel diaphragm and process connection Nitrile O-ring seal.	G
316 Stainless steel diaphragm and process connection Welded construction	S
Nickel alloy (Monel) diaphragm, 316 stainless steel process connection and Viton O-ring seal. NACE MR 01-75 compliant	K

Sentry Series
Models: P01, P02 & P03

Setting Ranges

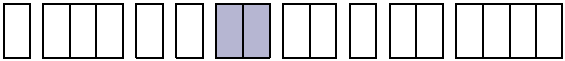
TABLE 5 

P_{max}		Model	Range		psi	in H2O / (in Hg)	Code	Deadband*	
bar	psi		mbar/(bar)	Code				mbar	in H2O / (in Hg) / [psi]
15	217	P01	12 to 250	CC		5 to 100	CW	9	3.5
			-120 to +120	CD		-50 to 50	CH	8	3.1
			100 to 600	CE	1.5 to 8.5	CK	15	[0.2]	
			-1000 to 0	A0		(-30 to 0)	AB	45	(1.3)
			(-1 to +1.5)	G3	-14.5 to 20	GK	48	[0.7]	

P_{max}		Model	Range				Deadband*	
bar	psi		bar	code	psi	Code	mbar	psi
27	400	P02	0.25 to 1.6	DB	4 to 25	DK	140	2.0
			0.4 to 2.5	DC	6 to 40	DP	180	2.6
			1 to 6	DE	16 to 100	DZ	230	3.3
70	1000	P02	1.6 to 10	EA	25 to 160	EH	340	4.9
			2.5 to 16	EB	40 to 250	EM	350	5.0
110	1600	P02	4 to 25	EC	60 to 400	ER	1050	15.2
			10 to 40	ED	160 to 600	EW	1400	20.3
			15 to 75	EF	250 to 1000	EE	1750	25.4
155	2250	P02	10 to 100	FA	160 to 1500	F6	3700	53.7

P_{max}		Model	Range				Deadband*			
bar	psi		bar	Code	psi	Code	mbar	psi		
350	5075	P03	0.4 to 2.5	DC	6 to 40	DP	400	5.8		
			1 to 6	DE	16 to 100	DZ	600	8.7		
		P03	1.6 to 10	EA	25 to 160	EH	800	11.6		
			2.5 to 16	EB	40 to 250	EM	800	11.6		
			P03	4 to 25	EC	60 to 400	ER	1200	17.4	
		10 to 40		ED	160 to 600	EW	2200	31.9		
		15 to 75		EF	250 to 1000	EE	2500	36.3		
		1000	15000	P03	10 to 100	FA	160 to 1500	F6	4500	65.3
					7 to 160	U7	100 to 2300	UK	6800	98.6
P03	25 to 250			V7	350 to 3500	VC	10000	145		
	50 to 400			W7	800 to 6000	W9	17600	255		
	100 to 700			Y4	1600 to 10000	YF	20000	290		

* Deadband figures are typical for Code 10 SPDT 15A microswitches (see Table 6) and non-welded wetted parts Codes A & G (see Table 4) with falling set-points at mid-scale. Deadbands for other microswitch options may differ. Due to manufacturing tolerances the figures quoted are for guidance only. Should the differential be critical for specific applications, our engineers should be consulted before ordering.

Switch Options

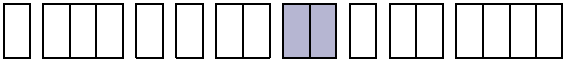
TABLE 6 

CSA Rating (RESISTIVE) §SEE NOTE	IEC 947-5-1/EN 60947-5-1 RATING							Contact	Code
	Designation & Utilization Category	Rated operational current le (A) at rated operational voltage Ue	Ui	Uimp	VA Rating				
						Make	Break		
5 A @ 110/250V AC Light Duty for AC only	AC14 D300	0.6/0.3A @ 120/240V AC	250V	0.8kV	AC	432	72	SPDT	00
	DC13 R300	0.22/0.1A @ 125/250V DC			DC	28	28	DPDT	01
1 A @ 125V AC & §100 mA @ 30V DC gold alloy contacts for low voltage switching	1 A @ 125 VAC RESISTIVE (IEC 1058-1/EN 61058-1)							SPDT	04
								DPDT	05
15 Amp @ 125/250/ 480 V AC & 2 A @ 30V DC General purpose precision	AC14 D300	0.6/0.3A @ 120/240V AC	250V	0.8kV	AC	432	72	SPDT	10
	DC13 R300	0.22/0.1A @ 125/250V DC	250V	0.8kV	DC	28	28	DPDT	11
5 A @ 110/250V AC Adjustable for AC only	AC14 D300	0.6/0.3A @ 120/240V AC	250V	0.8kV	AC	432	72	SPDT	1C
5 A @ 110/250V AC & 2 A @ 30V DC Adjustable	AC14 D300 DC13 R300	0.6/0.3A @ 120/240V AC 0.22/0.1A @ 125/250V DC	250V	0.8kV	AC DC	432 28	72 78	SPDT	1D
5 A @ 250V AC and 2 A @ 30V DC Hermetically sealed. Gold plated silver contacts.	AC14 D300	0.6/0.3A @ 120/240V AC	250V	0.5kV	AC	432	72	SPDT	H2 [†]
	DC13 R300	0.22/0.1A @ 125/250V DC			DC	28	28	DPDT	H3 [†] [^] H6 [†] [^]

† 2 Single pole, double throw, simultaneous falling under pressure
 ‡ 2 Single pole, double throw, simultaneous rising under pressure
 ^Terminal Block supplied as standard
 Note: For Low energy circuits e.g 30V and up to 100mA, we recommend using gold alloy contact switches
 Ui = rated insulation voltage: Uimp = rated impulse to withstand voltage across contacts.
 In the absence of any verification by CSA the microswitch § manufacturer's rating is stated in **italics and bold**.
 If in doubt seek guidance from the factory.

Process Connection

TABLE 7 

	Code
¼ NPT F: Direct	F
½ NPT M: Direct	J

Options & Treatments

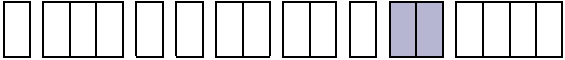
TABLE 8 

	Code
Stainless steel permanently fixed tags	20
Stainless steel wired on tag	30
Applies when – no option is required and selection is made from special engineering (see Table 9)	00

Sentry Series
Models: P01, P02 & P03

Special Engineering

Last 4 digits of model code only used when special engineering is required.

Performance Data

TABLE 9	
---------	--

	Code
Please consult Delta sales engineering for special requirements	TBA

TABLE 10

TABLES 10A, 10B, 10C, 10D.
MODEL P01, P02, P03
DIAPHRAGM OPERATED PRESSURE SWITCH

Due to manufacturing tolerances the figures quoted in these tables are for guidance only.

Should the differential be critical for specific applications, our engineers should be consulted prior to ordering.

MODEL P01/P02 PSI UNITS TABLE 10A

Code	Range H ₂ O / in Hg / psi	P _{max} psi	SWITCHING OPTIONS										
			SWITCHING DIFFERENTIAL IN H ₂ O / IN Hg / psi										
			00	01	10	11	04	05	08/0G	09/0H	H2	H3/H6	
CW	5 to 100	217	2.0	3.1	3.5	5.5	2.0	2.4	3.1	6.0	11.7	11.7	
CH	-50 to +50	217	3.1	5.5	3.1	9.0	3.1	3.1	5.5	7.0	8.0	8.0	
CK	1.5 to 8.5	217	3.1	5.5	6.0	9.0	3.1	4.7	5.5	7.0	18.0	18.0	
AB	-30 to 0	217	0.6	0.8	1.3	1.7	0.5	0.5	0.8	1.0	3.0	3.0	
GK	14.5 to +20	218	0.3	0.6	0.7	1.5	0.3	0.4	0.5	0.7	2.2	2.2	
DK	4 to 25	400	0.4	0.7	1.0	1.5	1.0	1.5	2.6	3.5	1.2	2.3	
DP	6 to 40	400	0.4	0.7	1.0	1.5	1.0	1.5	2.6	3.5	1.2	2.3	
DZ	16 to 100	400	0.6	0.9	1.7	2.0	1.5	2.2	3.5	1.6	2.9	5.8	
EH	25 to 160	1000	1.5	2.2	3.6	6.5	2.2	3.3	11.6	14.5	6.0	11.6	
EM	40 to 250	1000	2.2	4.0	5.1	9.9	3.6	5.8	13.1	17.4	7.5	14.5	
ER	60 to 400	1600	4.4	6.5	15.2	19.6	7.3	10.2	26.0	35.0	26.0	52.0	
EW	160 to 600	1600	7.3	11.6	20.0	26.0	11.6	17.4	44.0	46.0	31.0	61.0	
EE	250 to 1000	1600	9.4	14.5	25.0	33.0	14.5	22.0	44.0	58.0	51.0	102	
F6	160 to 1500	2250	14.5	22.0	51.0	65.0	29.0	44.0	87.0	116	73.0	145	

MODEL P01/P02 BAR UNITS TABLE 10B

Code	Range mbar/bar	P _{max} bar	SWITCHING OPTIONS										
			SWITCHING DIFFERENTIAL IN mbar										
			00	01	10	11	04	05	08/0G	09/0H	H2	H3/H6	
CC	12 to 250	15	5.0	8.0	6.0	8.0	5.0	6.0	8.0	15.0	30.0	30.0	
CD	-120 to +120	15	8.0	14.0	8.0	23.0	8.0	8.0	14.0	18.0	20.0	20.0	
CE	100 to 600	15	8.0	14.0	15.0	23.0	8.0	12.0	14.0	18.0	45.0	45.0	
A0	-1000 to 0	15	21.0	27.0	45.0	60.0	18.0	18.0	30.0	36.0	105	105	
G3	-1 to +1.5	15	21.0	40.0	48.0	100	24.0	30.0	36.0	45.0	150	150	
DB	0.25 to 1.6	27	30.0	45.0	70.0	100	70.0	100	180	240	80.0	160	
DC	0.4 to 2.5	27	30.0	45.0	70.0	100	70.0	100	180	240	80.0	160	
DE	1 to 6	27	40.0	60.0	120	140	100	150	240	320	200	400	
EA	1.6 to 10	70	100	150	250	450	150	230	800	1000	400	800	
EB	2.5 to 16	70	150	275	350	680	250	400	900	1200	500	1000	
EC	4 to 25	110	300	450	1050	135	500	700	1800	2400	1800	3600	
ED	10 to 40	110	500	800	1400	1800	800	1200	3000	3200	2100	4200	
EF	15 to 75	110	650	1000	1750	2250	1000	1500	3000	4000	3500	7000	
FA	10 to 100	155	1000	1500	3500	4500	2000	3000	6000	8000	5000	10000	

MODEL P03 PSI UNITS TABLE 10C

Code	Range psi	P _{max} psi	SWITCHING OPTIONS										
			SWITCHING DIFFERENTIAL IN psi										
			00	01	10	11	04	05	08/0G	09/0H	H2	H3/H6	
DP	6 to 40	5075	3.2	4.8	5.8	5.8	4.4	4.4	6.5	7.4	6.0	11.6	
DZ	16 to 100	5075	3.5	5.8	8.7	11.6	7.3	10.2	8.7	9.4	12.0	23.0	
EH	25 to 160	5075	5.5	10.2	11.6	17.4	8.7	13.0	8.7	11.0	18.0	35.0	
EM	40 to 250	5075	6.7	11.5	11.6	17.4	8.7	13.0	11.6	17.4	18.0	35.0	
ER	60 to 400	5075	12.5	20.0	17.4	23.0	11.6	17.4	20.0	22.0	34.0	67.0	
EW	160 to 600	5075	14.5	23.0	29.0	44.0	22.0	36.0	29.0	44.0	51.0	102	
EE	250 to 1000	5075	22.0	28.0	36.0	73.0	22.0	58.0	44.0	58.0	58.0	116	
F6	160 to 1500	5075	29.0	36.0	65.0	87.0	51.0	73.0	58.0	73.0	73.0	145	
UK	100 to 2300	15000	49.0	80.0	99.0	145	58.0	77.0	73.0	90.0	150	290	
VC	350 to 3500	15000	81.0	162	145	244	122	203	725	870	370	725	
W9	800 to 6000	15000	128	255	255	574	192	319	1160	1160	600	1160	
YF	1600 to 10000	15000	218	435	290	653	326	486	1450	1450	750	1450	

MODEL P03 BAR UNITS TABLE 10D

Code	Range bar	P _{max} bar	SWITCHING OPTIONS										
			SWITCHING DIFFERENTIAL IN mbar										
			00	01	10	11	04	05	08/0G	09/0H	H2	H3/H6	
DC	0.4 to 2.5	350	220	330	400	400	300	300	450	510	400	800	
DE	1 to 6	350	240	400	600	800	500	700	600	650	800	1600	
EA	1.6 to 10	350	380	700	800	1200	600	900	600	750	1200	2400	
EB	2.5 to 16	350	480	790	800	1200	600	900	800	1200	1200	2400	
EC	4 to 25	350	860	1400	1200	1600	800	1200	1350	1500	2300	4600	
ED	10 to 40	350	1000	1600	2000	3000	1500	2500	2000	3000	3500	7000	
EF	15 to 75	350	1500	1900	2500	5000	1500	4000	3000	4000	4000	8000	
FA	10 to 100	350	2000	2500	4500	6000	3500	5000	4000	5000	5000	10000	
U7	7 to 160	1000	3400	5500	6800	10000	4000	5300	5000	6200	10000	20000	
V7	25 to 250	1000	5600	11200	10000	16800	8400	14000	50000	60000	35000	50000	
W7	50 to 400	1000	8800	17600	17600	39600	13200	22000	80000	80000	40000	80000	
Y4	100 to 700	1000	15000	30000	20000	45000	22500	33500	100000	100000	50000	100000	

TABLE 10E, 10F. MODEL P02. DIAPHRAGM OPERATED STANDARD PRESSURE SWITCH

MODEL P02 PSI UNITS TABLE 10E

Code	Range psi	P _{max} psi	SWITCHING OPTIONS					
			SWITCHING DIFFERENTIAL IN psi					
			MIN	1C	MAX	MIN	1D	MAX
DK	4 to 25	400	0.2	1.1	1.0	2.9		
DP	6 to 40	400	0.3	1.2	1.3	3.0		
DZ	16 to 100	400	0.5	2.8	2.5	7.3		
EH	25 to 160	1000	1.9	6.2	6.4	16		
EM	40 to 250	1000	3.2	9.1	9.6	23		
ER	60 to 400	1600	9.6	35	41	88		
EW	160 to 600	1600	13	61	57	125		
EE	250 to 1000	1600	16	62	80	160		
F6	160 to 1500	2250	25	83	96	212		

MODEL P02 BAR UNITS TABLE 10F

Code	Range bar	P _{max} bar	SWITCHING OPTIONS					
			SWITCHING DIFFERENTIAL IN mbar					
			MIN	1C	MAX	MIN	1D	MAX
DB	0.25 to 1.6	27	11.0	78.0	66.0	200		
DC	0.4 to 2.5	27	22.0	82.0	88.0	210		
DE	1 to 6	27	33.0	190	170	500		
EA	1.6 to 10	70	132	430	440	1100		
EB	2.5 to 16	70	220	630	660	1600		
EC	4 to 25	110	660	2400	2800	6100		
ED	10 to 40	110	880	3300	3900	8600		
EF	15 to 75	110	1100	4300	5500	11000		
FA	10 to 100	155	1700	5700	6600	14600		

Sentry Series
Models: P01, P02 & P03

Approvals



EUROPEAN DIRECTIVE

Low voltage Directive (LVD) 2014/35/EU
Compliant to LVD

Pressure Equipment Directive (PED) 97/23/EU

This product has a process connection size ≤DN25 and is therefore categorised as Sound Engineering Practice (SEP) under Cat 3.3

ATEX Directive 2014/34/EU



INTRINSICALLY SAFE

Certificate No. Baseefa11ATEX0203
EN 60079-0, EN 60079-11

For Zone 0 models (**Enclosure code W/5, see Table 1**)

II 1GD Ex ia IIC T5 / T6 Ga (-60°C≤Ta≤+80°C) / (-25°C≤Ta≤+60°C)
Ex ia IIIC T135°C Da (-60°C≤Ta≤+80°C)

GLOBAL CERTIFICATION



IECEX Certified

INTRINSICALLY SAFE

Certificate No. IECEX BAS 11.0104X
IEC 60079-0, IEC 60079-11

Ex ia IIC T5 / T6 Ga (-60°C≤Ta≤+80°C) / (-25°C≤Ta≤+60°C)
Ex ia IIIC T135°C Da (-60°C≤Ta≤+80°C)



Functional Safety Certified

Meets the requirements of IEC 61508-2 for use in SIL 2 safety related systems
Certificate No. Sira FSP 12015/01

Dimensions

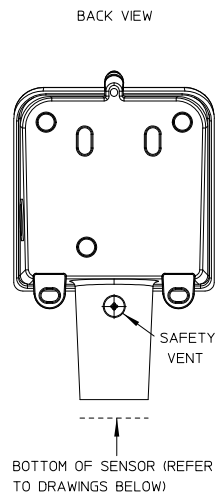
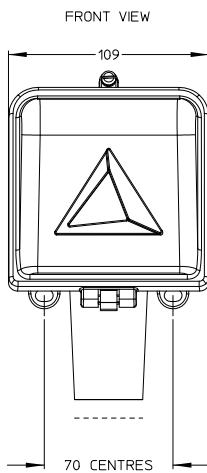
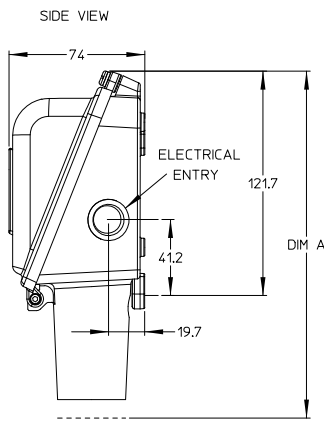

Model	Range	DIM A	DIM B
P01	CC, CD, CE	207*	88
	A0, G3	207*	63
P02 & P03	ALL	187	-

* WHEN 1/4" NPT PROCESS CONNECTION IS SELECTED. DIMENSION WILL DIFFER WITH ALTERNATIVE PROCESS CONNECTIONS.

Sentry Series
Models: P01, P02 & P03

In the interest of development and improvement Delta Controls Ltd, reserves the right to amend, without notice, details contained in this publication. No legal liability will be accepted by Delta Controls Ltd for any errors, omissions or amendments.

Delta Controls Limited
Riverside Business Park, Dogflud Way, Farnham, Surrey GU9 7SS, UK.
T +44 (0) 1252 729 140 F +44 (0) 1252 729 168 E sales@delta-controls.com W www.delta-controls.com



ISO9001
FM00720