

ONSITE MICRO OHMMETER



CE

User Manual



# OM 17

## Onsite micro ohmmeter



## User Manual

## **LIMIT OF GUARANTEE AND LIMIT OF RESPONSIBILITY**

AOIP S.A.S guarantees the absence of faulty materials and the manufacture of this product under normal conditions of use and maintenance. The guarantee period is one year and takes effect on the date of delivery. Parts, repairs to the product and service are guaranteed for a period of 90 days. This guarantee only applies to the original purchaser or the end user if he is a client of a AOIP S.A.S approved distributor and does not cover fuses, interchangeable batteries/cells nor any product which, in the opinion of AOIP S.A.S, has been badly handled, modified, neglected or damaged by accident or subjected to abnormal conditions of use or handling. AOIP S.A.S guarantees that the software will function largely in accordance with its functional specifications for a period of 90 days and that it has been correctly recorded on nondefective media. AOIP S.A.S does not guarantee that the software contains no errors or that it will operate without interruption. AOIP S.A.S approved distributors shall apply this guarantee to products sold to new clients it has not served, but are not authorised to offer a longer or different guarantee in the name of AOIP S.A.S. Guarantee support is offered if the product was purchased by an intermediary from an AOIP S.A.S approved point of sale or if the purchaser has paid the applicable international price. AOIP S.A.S reserves the right to invoice the purchaser for the costs of importing, repair or replacement parts if the product purchased in one country was sent to another country for repair.

The obligations under the guarantee of AOIP S.A.S are limited at the discretion of AOIP S.A.S, to reimbursement of the purchase price, or the free repair/replacement of a defective product returned within the period of the guarantee to an AOIP S.A.S approved service center.

To claim for service under the guarantee, contact the nearest AOIP S.A.S agent or send the product, accompanied by a description of the problem, carriage and insurance paid (free on board destination), to the nearest AOIP S.A.S approved service centre. AOIP S.A.S declines any responsibility in the event of damage occurring during transportation. After repair under guarantee, the product will be returned to the purchaser, carriage paid (free on board destination). If AOIP S.A.S considers that the problem was caused by abusive treatment, modification, an accident or abnormal conditions of operation or handling, AOIP S.A.S will submit a quotation for the cost of repair and will only commence the repair after receiving authorisation. After repair, the product will be returned to the purchaser, carriage paid, and the costs of repair and transportation will be invoiced to him.

**THIS GUARANTEE IS EXCLUSIVE AND REPLACES ANY OTHER GUARANTEES, EXPLICIT OR IMPLIED, INCLUDING, BUT NOT LIMITED TO, ANY IMPLIED GUARANTEE AS TO THE SUITABILITY OF THE PRODUCT TO BE SOLD OR APPLIED TO A PARTICULAR PURPOSE OR USE. AOIP S.A.S SHALL NOT BE HELD RESPONSIBLE FOR ANY PARTICULAR INDIRECT, ACCIDENTAL OR CONSEQUENTIAL DAMAGE, NOR ANY CORRUPTED OR LOST DATA, WHETHER AS A RESULT OF AN INFRACTION OF THE OBLIGATIONS OF THE GUARANTEE, OR ON A CONTRACTUAL, EXTRA-CONTRACTUAL OR OTHER BASIS.**

Because some countries or states do not permit limitations to an implied condition of guarantee, or the exclusion or limitation of accidental or consequential damage, the limitations and exclusions of this guarantee may not apply to every purchaser. If any condition of this guarantee is considered invalid or inapplicable by a competent court, such a decision will in no way affect the validity or binding nature of any other condition.

CONTENT

<b>A. GENERAL</b> .....	<b>6</b>
A.1 INTRODUCTION .....	6
A.2 APPLICATIONS .....	6
A.3 MAIN CHARACTERISTICS .....	7
A.4 SAFETY PROVISIONS .....	7
A.4.1 Compliance with Safety Standards .....	7
A.4.2 Following Instructions supplied with the accompanying Documents .....	7
A.4.3 Taking Measurements .....	7
A.4.4 Instructions to be followed before Use .....	7
A.4.5 Faults and abnormal Constraints .....	8
A.4.6 Table of Symbols used .....	8
A.4.7 Maintenance .....	8
<b>B. DESCRIPTION</b> .....	<b>9</b>
B.1 General View .....	9
B.2 DISPLAY .....	10
B.3 ACCESSORIES .....	11
B.3.1 Delivered with the Unit .....	11
B.3.2 Options delivered to order .....	11
<b>C. OPERATION</b> .....	<b>12</b>
C.1 REMINDERS OF THE 4-WIRE PRINCIPLE .....	12
C.2 PERFORMING A MEASUREMENT .....	12
C.2.1 Switching On .....	14
C.2.2 Selecting the Range .....	14
C.2.3 Selecting the Measurement Mode .....	14
C.2.4 Ambient temperature compensation .....	18
C.2.5 Setting Alarms .....	19
C.2.6 Connecting to Connectors .....	19
C.2.7 Standby (STBY) Position .....	20
C.3 LIST OF ERROR MESSAGES .....	21
C.4 CONFIGURING THE UNIT .....	22
C.4.1 Principle .....	22
C.4.2 Direct Access Key .....	22
C.4.3 Entering a Number .....	22
C.4.4 Programming Menu Table .....	23
C.4.5 Managing an Alarm Threshold: ALAr .....	24
C.4.6 Using the DB9 Connector: rS .....	24
C.4.7 Managing and printing Memory Content: mEm .....	24
A.1.1 Programming the temperature compensated measurement Value .....	28
<b>CONFIGURATION AND OPERATION COMMANDS USING THE RS232 SERIAL LINK</b> .....	<b>29</b>
C.5 INTRODUCTION .....	29
A.1.2 Command Errors .....	30
C.6 LIST OF COMMANDS .....	31
C.7 GENERAL COMMANDS .....	32
C.8 PROGRAMMING COMMANDS .....	33
C.9 MEMORY USAGE COMMANDS .....	36
C.10 OTHER INFORMATION COMMANDS .....	38
C.11 LOGOM PROGRAM .....	38
A.1.3 Installation .....	38
A.1.4 Use .....	38
<b>D. MAINTENANCE</b> .....	<b>40</b>
D.1 OPENING/CLOSING THE UNIT .....	40
D.2 BATTERY PACK .....	42
D.2.1 Charging .....	42
D.2.2 Replacing the Battery .....	42
D.3 FUSES .....	42
D.4 CHECKING PERFORMANCE .....	43
D.5 MANAGING MAINTENANCE .....	43
D.6 UPDATING THE ON-BOARD SOFTWARE .....	44
D.7 ADJUSTMENT .....	45
D.7.1 Environment .....	45
D.7.2 Adjusting the Unit .....	45
D.8 WARRANTY .....	46
<b>E. SPECIFICATIONS</b> .....	<b>47</b>
E.1 APPLICABLE STANDARDS .....	47
E.1.1 Safety Class .....	47
E.1.2 EMC Conformity .....	47
E.1.3 Ambient Conditions .....	47
E.1.4 Mechanical Conditions .....	47
E.1.5 Measurement under Reference Conditions .....	47
E.2 CHARACTERISTICS .....	48
E.2.1 General .....	48
E.2.2 Resistance measuring function .....	48
E.2.3 Protections .....	48
E.3 END OF UNIT SERVICE LIFE .....	49
E.3.1 Waste Generated by the Unit .....	49
E.3.2 Unit Destruction Procedure .....	49
<b>F. ANNEXES</b> .....	<b>50</b>
F.1 UNIT MAINTENANCE PROGRAMMING DIAGRAM .....	51
F.2 DIAGRAMME DE PROGRAMMATION ET DE LECTURE DE L'APPAREIL .....	52

## A. GENERAL



We are very grateful to you for choosing this AOIP S.A.S accuracy measuring instrument which benefits from our hundred years experience in the manufacture of high quality, accuracy measuring instruments. Because of this, we are able to continue our policy of continuous innovation which has served our customers so well for the last 100 years. AOIP S.A.S encourages your comments and would willingly accept any suggestions from you to help us to perfect our know-how and improve our future products .



### A.1 Introduction

The OM 17 microhm meter is used to perform 4-wire low resistance measurements from 0.1  $\mu\Omega$  (resolution) to 2,500  $\Omega$  over seven ranges.

Made in a sturdy and heavy-duty housing, autonomous in operation, it is well suited for on-site measurements.

### A.2 Applications

Its main applications are listed below:

- Metallic coating measurement, especially in aeronautics.
- Ground continuity measurement.
- Resistance measurement over motors and transformers.
- Contact resistance measurement.
- Component measurement.
- Electric cable resistance measurement.
- Mechanical bond tests.



### A.3 Main Characteristics

- Programming and operating the unit using a 14-key keypad: selection of range, measurement mode (low inductive or inductive resistance), temperature compensation and measurement triggering.
- Measurement memory function.
- Programmable alarms that are triggered when thresholds are exceeded.
- Portable unit with battery pack comprising five Ni-MH accumulators, 8.5 Ah (D cell size).

Battery pack recharge: A charger built into the OM 17 recharges the batteries by connecting the unit to the line (90 V/264 V, 45 Hz/420 Hz), using a standard cord.

Recharge time: 5 hours.

Endurance: 5,000 measurements using a 10 A current level in low inductive mode.

- 4-wire measurement with automatic compensation of spurious voltages.
- Automatic compensation of ambient temperature by measuring it using an external sensor or by manual entry and programming of the metal type or its temperature coefficient.
- LCD display.
- Direct display of the measurement together with its unit, range, measurement mode and if required, temperature compensation.

Measurement can be triggered from the keypad, remotely, or in automatic mode.

- Sealed, sturdy casing.
- Dimensions: 270 mm x 250 mm x 180 mm.
- Weight: approximately 4 kg

### A.4 Safety Provisions

#### A.4.1 Compliance with Safety Standards

The unit has been constructed and tested in accordance with safety rules relating to electronic measuring instruments.

This instruction manual contains information and cautionary advice that users must follow to: protect themselves against electrical shocks, ensure the reliability of the unit, and make sure that the unit is not used in a way that could damage it or make it unsafe for use.

#### A.4.2 Following Instructions supplied with the accompanying Documents

The unit is constructed to operate in complete safety as long as the instructions supplied with the accompanying documents are followed. Any usage, except those described, may impair operator safety and is therefore dangerous and prohibited..

#### A.4.3 Taking Measurements

The test leads and measuring wires must be in good condition and should be changed if there is any evidence of deterioration (insulation split, burnt, etc.).

Never exceed the safety values indicated in the specifications.

**Never connect the unit to a live circuit.**

When the unit is measuring resistance showing a high inductive component (transformers, motors, etc.) **after ending the measurement (with the measurement current cut-off)**, the unit then discharges this inductance

and displays the icon  for this entire duration.

**Never disconnect the connection wires before this icon disappears.**

#### A.4.4 Instructions to be followed before Use

##### a) *Charging batteries*

During battery charge, instrument must be placed on a flat surface with cover opened, in order to connect instrument to the main power supply. (The cable plug and the main are creating a disconnecting device ) .

During battery charge, any other cable must be disconnected and removed from the instrument

Power cable must remain the one supplied with the instrument (H03VVH2-F2).

The OM 17 unit has been mechanically and electrically tested prior to shipping. It has been handled with all of the necessary care to ensure that it reaches the user undamaged. It is, however, good practice to perform a quick check in order to detect any deterioration that may have taken place in transit. If any deterioration is found, declare any reservations to the carrier immediately.

**b) Return Shipping**

If return shipping is required, the unit should preferably be sent back in its original packaging, with a note attached to it stating as clearly as possible the reason for its return.



**A.4.5 Faults and abnormal Constraints**

Should there be any indication that the protection of the unit has been compromised, it should be switched off and steps taken to prevent it being used inadvertently.

Protections may have been compromised in the following cases, for example:

- The unit is obviously damaged.
- The unit is no longer capable of taking accurate measurements.
- The unit has been stored under unfavourable conditions.
- The unit has been subjected to severe stresses during transport.

**A.4.6 Table of Symbols used**

Symbol	Description
	Double insulation.
	Warning: see the accompanying documents.
	Measurement earth terminal.

**A.4.7 Maintenance**

The fuse replacement of the instrument, the fuse located on the battery replacement and adjusting the instrument procedure are described in chapter E

The unit should be reassembled as explained in the instruction manual. If the unit is incorrectly or incompletely reassembled, the operator's safety may be compromised.

The responsible body must check on a regular basis that none of the components ensuring safety has deteriorated, and undertake all the necessary steps for preventive operations.

Before the casing is opened, make sure that the measuring leads have been disconnected from the unit **and that the mains cord is also disconnected.**

The unit should not be opened up for adjustment, maintenance or repair unless this is absolutely essential, in which case this work should be carried out **only by qualified personnel advised of the risk entailed**



**B. DESCRIPTION**

**B.1 General View**

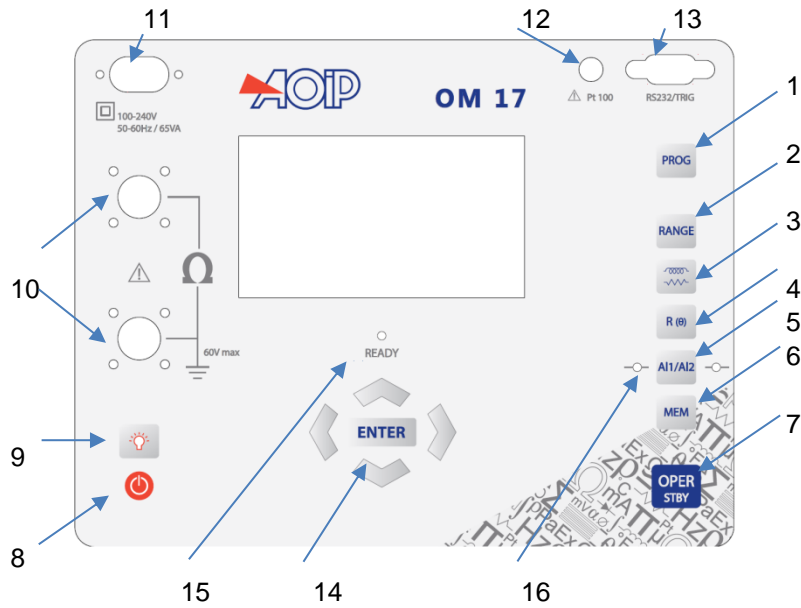

KEY	FUNCTION
1	Programming menu
2	Range selection
3	Measurement and automatic triggering modes
4	Temperature compensation
5	Alarms
6	Memories
7	Start or stop measurement
8	On/Off
9	Lighting
10	Measurement connectors
11	Power connector for recharging the battery pack
12	Pt100 connector
13	RS232 connector/"trigger" connector
14	Cursor keys
15	READY LED
16	AL1 and AL2 LEDs

## B.2 Display

Liquid Crystal Display (LCD), with icons and two number fields.

Two number fields. One with 4 digits and one with 5 digits and their units. The ambient temperature level is displayed on the top line in "temperature compensation" mode. The bottom line is used to display the measured values.

Errors are indicated by the appropriate messages.

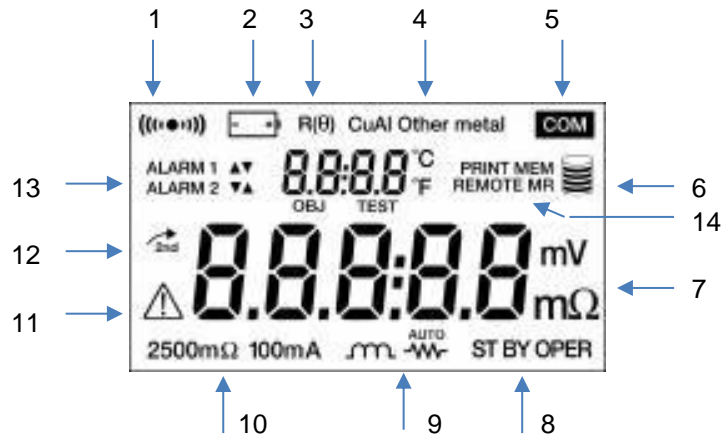

REPERE	FONCTION
1	Buzzer on
2	Battery condition
3	Temperature compensation function on
4	Metal selection for measurement compensation mode
5	PC or printer communication in service
6	Memory usage level
7	Measurement units
8	Unit status: "Standby" or "Operate"
9	Measurement modes
10	Measurement range and current level
11	Danger do not disconnect the measurement wires
12	Not used
13	Alarms switched on and activation direction selected
14	REMOTE PRINT MEM MR Unit is PC controlled Print memories Store measurements in memory Read memories

## B.3 Accessories

### B.3.1 Delivered with the Unit

- A standard mains cord for recharging the battery pack.
- An instruction manual.

### B.3.2 Options delivered to order

AMT 005: Dagger style test probe.

AMT 006: Kelvin clip, 25 mm jaw.

AMT 008: Extension cable, 20 meters long for clips and probes.

AMT 011: Compact test probe.

AMT 012: Kelvin clips, 12 mm jaw.

AMT 013: Dagger style test probe, remotely triggered.

AMT 014: Temperature sensor.

AMT 015: Extension cable, 5 meters long for AMT 014 temperature sensor.

#### **Software**

LogOM: PC software + RS232 cable. This software is used to read the measurements stored and to configure the unit.

#### **Communication cables**

AN5909: RS232 cable for connecting the OM 17 to a PC.

AN5875: RS232 cable for connecting the OM 17 to a printer.

ER 41057-000: Europe model mains cord.

ER 41057-001: UK model mains cord.

ER 41057-0002: US model mains cord.

**REMARK: The clips and test probes are sold individually and not in pairs.**

#### ▪ **Certification**

QMA11EN	Calibration certificate COFRAC
QMA30EN	factory test report

**C. OPERATION**

**C.1 Reminders of the 4-wire Principle**



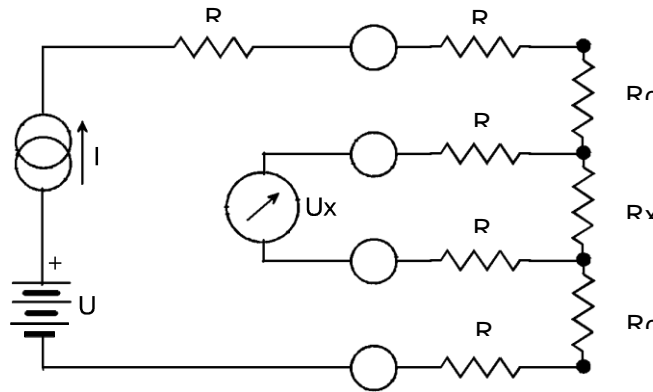



The principle of this connection is shown in the diagram below.



- R<sub>i</sub> = Unit internal resistance.
- R<sub>f</sub> = Measurement wire resistance.
- R<sub>c</sub> = Contact resistance.
- R<sub>x</sub> = Resistance to be measured.

From a DC voltage source U, a generator supplies a current of value I.  
 A voltmeter measures the voltage drop U<sub>x</sub> at the terminals of the resistance to be measured R<sub>x</sub> and displays R<sub>x</sub> = U<sub>x</sub> / I.  
 The result is not affected by the other resistances encountered in the current loop (R<sub>i</sub>, R<sub>f</sub>, R<sub>c</sub>), as long as the total voltage drop induced across R<sub>x</sub> remains below the voltage supplied by the source U (5 V ≤ U ≤ 6 V). The maximum admissible wire resistance level is R<sub>f</sub> ≈ (U - U<sub>x</sub>) / I

**C.2 Performing a Measurement**

1. Press  to switch the unit on.
2. Press  to choose the measurement range.
3. Press  to choose the measurement mode: inductive, low inductive, low inductive and automatic triggering.
4. Press  to implement temperature compensation.
5. Press  to switch the alarms on.
6. Connect the measurement wires to the connectors and connect them to the resistors.
7. Press  to start measurements.

8. The unit displays the measurement value or an error message.
9. Press  to stop measurements (the measurement process is automatically switched off in low inductive mode).



**C.2.1 Switching On**

Press the button shown above to switch the unit on.

**Important: Always choose the correct mains frequency for your location (50 or 60 Hertz)** (refer to section E.5. "Managing Maintenance").

The unit is powered by its NI-MH battery pack.

If the battery's charge level is too low, the unit displays:

- During a measurement, Err 01.
- In standby: 

The user must then recharge the battery (refer to Section 5). **The unit cannot perform measurements while it is charging.**





**C.2.2 Selecting the Range**

Press this button as many times as necessary to select the range. The range and the measurement current are displayed on-screen.

Ranges (Ohm)	Measurement current (A)
0.005	10 A
0.025	10 A
0.250	10 A
2.500	1 A
25	0.1 A
250	0.010 A
2 500	0.001 A

**C.2.3 Selecting the Measurement Mode**

Press this button as many times as necessary to select the measurement mode. The display shows:

-  Inductive resistance measurement
-  Low inductive resistance measurement
- **AUTO** Low inductive resistance measurement and automatic triggering



a) "Inductive Resistance" Measurement Mode



This mode is intended for performing measurements on transformers, motors and any inductive component.

Make sure that the display shows the icon.

From the standby position, to start a cycle:



- Press.
- Check that the "current" and "voltage" wires are correctly connected: if they are incorrectly connected, the display shows an error message with a number (Err 11: "current" wires incorrectly connected, Err 12: "voltage" wires incorrectly connected). The unit returns to the standby position and will continue its cycle once the connections are correct.
- With the current switched off, the residual voltage (U0) across the resistor terminals is measured. If this voltage level is too high, the unit displays Err 13.
- **The current (I) is switched on: it remains permanent until the unit returns to "standby".**
- The voltage across the resistor terminals (U1) is measured and the measurement  $R = (U1 - U0) / I$  is displayed.
- All subsequent measurements comprise only a Un measurement as Uo remains in memory.



- The cycle is stopped by pressing.

Operating diagram:

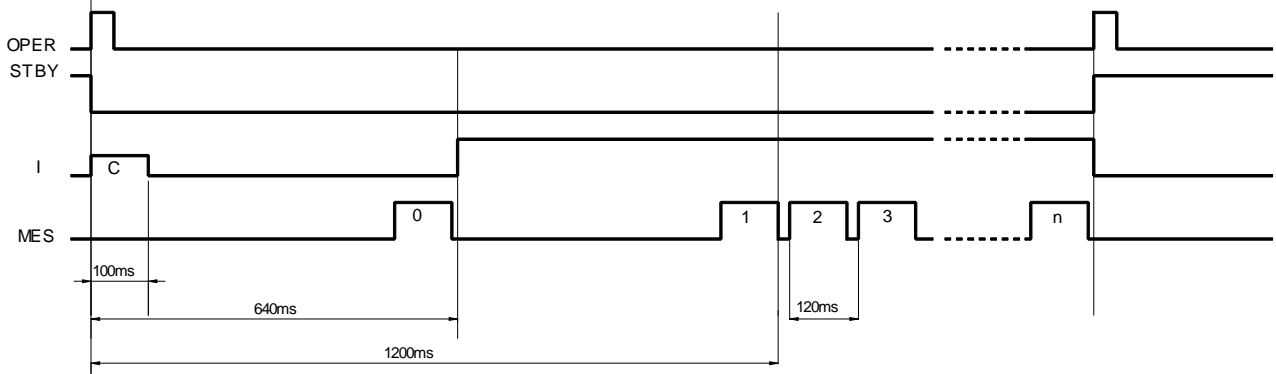

C = connection check

0 = residual voltage measurement (stored).

1,2,3...n = successive voltage measurements across the resistor terminals.

Interval between two measurements: 120 ms.

The delay time specified for the first measurement (1,200 ms) is an indication only; it may vary depending on the load level measured.

REMARKS:

1. If the range is exceeded, the unit displays Err 07.
2. The current source is thermally protected (measurement at 10A for a length of time in excess of a few tens of seconds causes heating). In this case a safety feature cuts the current and the unit displays Err 05.

We recommend letting the unit cool off before performing a new measurement.

3. Any change of range will stop the cycle and the unit returns to standby.
4. After a measurement cycle, the unit fully discharges the inductance. Returning to standby implies waiting

for the complete discharge of the inductance by the OM 17. During discharge, the unit displays the icon. **For operator safety reasons, during this time and as long as this icon is displayed, it is essential not to touch the connection wires.**

b) "Low Inductive Resistance" Measurement Mode



This mode is intended for measuring contact and metal plating resistance levels, and as a general rule, any resistance level with a time constant that is less than a few milliseconds. **In this mode only one measurement is performed per cycle.**

Make sure that the display shows the  icon.

The advantages of this mode include:

- Increasing unit autonomy.
- Reduced power consumption as the current is cut between measurements.
- Less heating of the measured resistor.
- Improved compensation of stray emfs as these are measured and compensated before each resistance measurement.

From the standby position, to start a cycle:



- Press .
- Check that the "current" and "voltage" wires are correctly connected: if they are incorrectly connected, the display shows an error message with a number (Err 11: "current" wires incorrectly connected, Err 12: "voltage" wires incorrectly connected). The unit returns to the standby position.
- With the current switched off, the residual voltage (U0) across the resistor terminals is measured. If this voltage level is too high, the unit displays Err 13 and returns to standby position.
- The current (I) is switched on.
- The voltage across the resistor (U1) is measured, then the current is cut.
- The measurement  $R = (U1 - U0) / I$  or an error message Err 07 is displayed, if an overrange occurs.
- Return to the standby position at the end of the measurement. The unit is ready to perform another measurement.

Operating diagram

Example: two measurement cycles

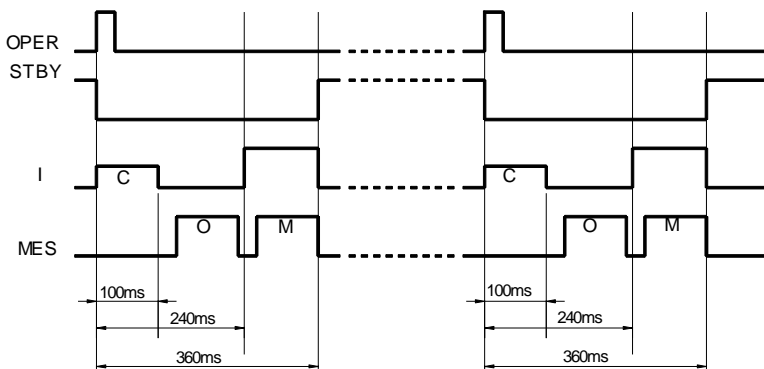

- C = connection check
- O = residual voltage measurement
- M = measurement of the voltage across the resistor terminals.

REMARKS:

If the range is exceeded, the unit displays Err 07.

c) "Low Inductive Resistance and Automatic Triggering" Measurement Mode **AUTO**

This mode is intended **only** for measuring resistance levels without a time constant. The use of the dagger prod connector detailed in the accessories section is recommended.

From the standby position, to start a cycle:



- Press  to start the cycle.
- Connect the wires to the resistor. The unit waits until it detects that the currents and voltage wires are connected correctly.
- Residual voltage (U0) measurement across the resistor terminals.
- The measurement current (I) is established, the voltage across the resistor terminals (U1) I measured and the measurement  $R = (U1-U0)/I$  is displayed.
- To start a new measurement cycle: **Release at least one connection, then reconnect it.**



- To stop the cycle, press .

## REMARKS:

If the range is exceeded, the unit displays Err 07.

Any change of range will stop the cycle and the unit returns to the standby position.

It is possible to store and compensate measurements while the cycle is running.

R (θ)

C.2.4 **Ambient temperature compensation**

a) *Principle*

The metals used in the windings of certain components (for example, the copper wire used in transformer or motor windings) have high temperature coefficients of the order of 0.4%/°C (for copper or aluminium). This leads to resistance level measurements that are highly dependent on the temperature of the component.

R (θ)

The "Temperature Compensation" function can be accessed by pressing the key. It is used to return the resistance value, which is dependent on the ambient temperature (whether measured or programmed), to the value that it should have at a reference temperature level:

The compensated resistance level is expressed as follows:

$$R(T_{ref}) = \frac{R(T_{amb}) * (1 + \alpha * T_{ref})}{1 + \alpha * T_{amb}}$$

- R(Tamb) → the resistance value measured at ambient temperature
- Tamb → the temperature level measured by a Pt100 probe or programmed by the user
- alpha → the temperature coefficient of the chosen metal (Aluminium, Copper, "Other metal")
- Tref → the programmed reference temperature to which the measurement level is returned

These parameters are programmable ones (refer to sub-section 3.4).

R (θ)

b) *Using the Compensation Function*

- Check parameter programming (see sub-section 3.4.8) and the connections made.
- Press this key; the unit displays the following information on-screen:  
R (θ), the chosen metal and the temperature levels **Tref then Tamb**.



- Select the range and the measurement mode, and press the key.

The unit performs a measurement cycle and directly displays the compensated resistance value and, depending on how it is programmed, displays one of the following:

1. The programmed ambient temperature level.
2. The temperature level measured by the temperature sensor.
3. "- - -" if the temperature sensor is validated but:
  - is incorrectly or not connected at all.
  - the measured temperature level is out of range (from -10°C to 55°C).

If a temperature level is out of range or if the sensor wires become disconnected, the unit displays Err 10.

Al1/Al2

C.2.5 **Setting Alarms**

Alarms are validated by successively pressing this key. The unit displays one of the following:

- Alarm 1 and the trigger direction.
- Alarm 2 and the trigger direction.
- Alarm 1 and Alarm 2 and their trigger directions.

These value and direction parameters are user programmable (see sub-section 3.4.5: "Managing an Alarm Threshold").

The AL1 and AL2 LEDs light up when the respective programmed threshold values are reached.

C.2.6 **Connecting to Connectors**

The measurement wires are connected using lockable cylindrical connectors.

Any drop in the voltage on the load terminals is measured between the two "voltage" (U) wires.

The current wires I can deliver a current level that varies from 1 mA to 10 A.

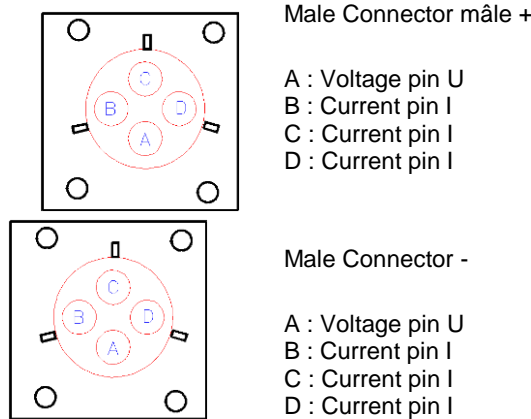

The DB9 connector is used to trigger remote measurements ("TRIG").

On the trigger test prod, the "READY" LED indicates that a measurement can be made.

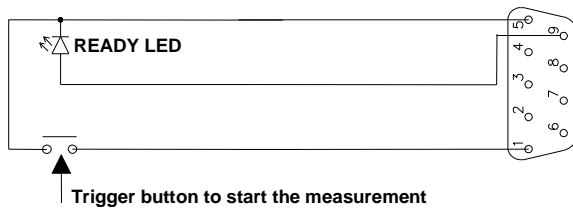

The DB9 connector is used for RS232 communication with a PC or a printer.

The main connection pins used are:

Male connector	PC	OM 17	Female connector
	Pins	Pins	
Rx	2 □	3	Tx
Tx	3 □	2	Rx
Gnd	5	5	Gnd

Female connector	Printer	OM 17	Female connector
	Pins	Pins	
Rx	2 □	2	Rx
Tx	3 □	3	Tx
CTS	8 □	8	CTS

A "Pt100" type thermometric resistor can be connected to the unit (using an extension cable if necessary) to perform compensated measurements. The use of a temperature sensor listed in the Accessories section is recommended.

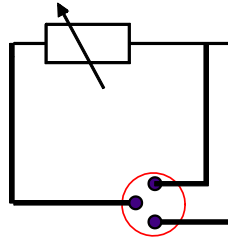

Pt100 connector



C.2.7 **Standby (STBY) Position**

The READY LED is lit when a measurement can be performed.

This is the standby position that the unit returns to at the end of a measurement cycle after:

- the user presses this key
- changes the measurement mode
- every low inductive mode measurement, or if an error is detected.

It is characterized by a pause before a new measurement cycle begins.



### C.3 List of Error Messages

Error number	Comments
Err 01	Battery too low.
Err 02	Internal problem.
Err 03	Cannot measure battery charge.
Err 04	Cannot measure the temperature.
Err 05	Excessive current source heating. Allow it to cool.
Err 06	Measurement current level not established.
Err 07	Measurement out of range.
Err 08	Internal problem.
Err 09	Measurement cycle stopped.
Err 10	Temperature sensor incorrectly connected or missing.
Err 11	"Current" wires incorrectly connected.
Err 12	"Voltage" wires incorrectly connected or measured resistance level too high.
Err 13	Residual voltage level too high.
Err 21	Adjustment value out of range.
Err 22	Measured value out of range.
Err 23	Entry out of range.
Err 24	Cannot write to the protected memory.
Err 25	Cannot read from the protected memory.
Err 26	Memory full.
Err 27	Memory empty, no data available.
Err 28	Memory check problem.
Err 29	Incorrect "object" or "test" number.

**WARNING:** If error messages 2, 3, 4 and 8 are displayed, the unit must be shut down and returned for servicing.



## C.4 Configuring the Unit

### C.4.1 Principle



The unit's configurable parameters can be accessed by the user by pressing the  key. The display shows "SET".

The "arrow up" and "arrow down" cursor keys let you browse through the programming menu.

A specific function is chosen by pressing the "right arrow" or ENTER keys.

To exit the programming menu, press the PROG button once again.

### C.4.2 Direct Access Key



After pressing the  key, you can directly access the following functions:

Direct access keys	Functions
ALARM	Display or change alarm thresholds (sub-section 3.4.5).
Rx	2 <input type="checkbox"/>
Tx	3 <input type="checkbox"/>
CTS	8 <input type="checkbox"/>

### C.4.3 Entering a Number

Numbers are entered using the cursor keys, digit by digit.

The blinking digit is the one currently being entered.

Once the last digit is entered, press the right arrow key to validate the number entered.

Using keys while entering a number

keys	Functions
Down arrow	To increment the selected digit
Up arrow	To decrement the selected digit
Right arrow	To move to the next digit
Left arrow	To return to the previous digit
ENTER	To validate the number entered
PROG	To cancel the number entered

When entering a **negative** number (for example, a negative temperature), the first digit corresponds to the sign. The ARROW keys call it up and clear it.

C.4.4 **Programming Menu Table**

Refer to the Appendix for a full diagram.

DISPLAY	FUNCTION
SEt	Reserved for unit maintenance purposes. This function is password protected (sub-section 5.5, "Managing Maintenance").
mEm (memory)	Managing the measurement values stored in memory (sub-section 3.4.7, "Managing and Printing Memory Content"). <ul style="list-style-type: none"> <li>- Viewing a measurement</li> <li>- Printing a measurement result</li> <li>- Clearing measurement values</li> </ul> Reading the space taken up in memory
LiGH (light)	Switching the display off automatically. To preserve battery power, display lighting can be switched off automatically, 1, 5 or 10 minutes after the last key has been pressed. The "OFF" choice in the sub-menu disables this function.
ALAr (alarm)	Choosing the value and direction of alarm thresholds. Used to validate an audible signal when one of the thresholds is reached. See section 3.4.5, "Managing an Alarm Threshold".
dEg (degrees)	Choosing the temperature measurement unit (°C or °F).
ALPH (alpha)	Enters a number between 0 and 100.00 corresponding to the non-standard metal coefficient (the "METAL" function described below). The coefficient must be expressed as $10^{-3} / ^\circ\text{C}$ . For copper, for example, the following entry can be made: alpha = 3.93.
mEtA (metal)	Chooses the type of metal for temperature compensation purposes and the temperature coefficient assigned to it. Two metals are supported as standard (Copper, Aluminium) and one other metal can be chosen at the user's discretion. The latter has to enter the temperature coefficient assigned to this metal (the "ALPHA" function mentioned above). Every time ENTER is pressed, the type of metal changes (see sub-section 3.4.8).
tAmb (temperature - ambient)	Chooses the ambient temperature measured by a "Pt100" probe or a fixed temperature level. In this case, a value corresponding to the ambient temperature at which the resistance measurement was taken is used.
trEF (temperature - reference)	Enters a value corresponding to the reference temperature to which the resistance measurement is returned.
LAng	Chooses the language, French or English, used for printing labels.
EdPP	Displays the program number.
EdSn	Displays the serial number.
bUZZ (buzzer)	Chooses the buzzer sound level (off, low, high). This function does not affect alarms which have their own special mode.
rS	Chooses the DB9 connector usage mode (see sub-section 3.4.6).

**C.4.5 Managing an Alarm Threshold: ALAr**

*a) General*

The alarm programming menu offers the option of choosing two alarm thresholds. An alarm comprises a value, a direction and a sound level setting for the buzzer, should the alarm become active. The direction setting is used to choose whether the alarm becomes active below a user-entered trigger threshold or over it.

*b) Successive Choices Available*

The selection is made using the cursor keys.

- Choosing the alarm number: **Alarm 1** or **Alarm 2**.  
The previous choice is displayed (value, direction, buzzer).
- Choosing the alarm triggering direction: **(down, up)** icon.
- Choosing the buzzer sound level: **(off, low, high)** icon.
- Choosing the threshold value ignoring the decimal point.  
Refer to entering a number.
- Choosing the unit and range in which the value is expressed.  
Choosing a unit with the icon **(mΩ, Ω)**.  
The range is chosen by **moving the decimal point**.
- Validating the new alarm setting: press the **right arrow** one last time.  
The display moves on to alarm 2, otherwise it returns to the programming menu.

Icons	Icon meaning
	Alarm triggering direction:  up  down
	Buzzer sound level.

Remarks on threshold validation.

At any time, pressing ENTER will validate the alarm being changed.

At any time, pressing PROG will exit the alarm entry sequence without validating the changes made.

**C.4.6 Using the DB9 Connector: rS**

This menu offers a choice of how to use the DB9 connector.

There are four possible choices, corresponding to four different functions.

Functions are selected using the cursor keys.

Various choices are possible:

OFF	Disable input and output functions via this connector. This choice saves battery power.
TRIG	Trigger the remote measurement function.
PC	Activate an RS232 link between a computer and the unit. Displays the COM icon.
VT100	Activate an RS232 link between a display terminal and the unit. Displays the COM icon.
PRNT	Activate an RS232 link between a printer and the unit. Displays the COM icon.

Choosing an RS232 link opens a sub-menu used to set the transmission speed between the unit and the peripheral.

Speeds available : 4800, 9600, 19200, 31250 baud.

Imposed settings : 8 bits, no parity, 1 stop bit, hardware control (CTS).

**C.4.7 Managing and printing Memory Content: mEm**

*a) General*

The memory is organised into 99 objects, each containing a maximum of 99 measurement tests.

The maximum number of measurements stored is approximately 1,500.

After performing a measurement, it is saved to memory by pressing the MEM key. The MEM icon blinks. The application proposes an empty object and test for storing this measurement.

Example: object 1 and test 4 are displayed:

**01 : 04.**  
 OBJ : TEST

The "test" units figure blinks; you can then change the object and test numbers using the arrow keys. FREE is displayed when the location is free, OCC is displayed when the location is already taken.

After choosing the measurement's memory location, pressing the MEM key validates memory storage in a FREE location. In an OCC location, the OCC message blinks to warn the user that this memory location is already taken. The program thus requests that the user confirm the storage action by pressing the MEM key again before storing the value in this location. The former measurement value stored in this location will be deleted to make way for the new measurement value.

*b) Stored Measurement Memory Display or Delete Menu*

The following five sub-menus are proposed in the "MEM" menu:

MEM R	Review the measurements stored. See below.
MEM P	Display the memory occupation percentage. E.g.: 012.32 = 12.32% of the memory is occupied. An icon is drawn on the right-hand side of the display as the memory fills up, and looks like this when it is full: 
MEM I	Print the stored measurements. The PRINT icon is displayed. Refer to the MEM R command described below to choose a test memory.
DEL	Delete all of the stored measurements. The program requires a DEL Y confirmation sequence to complete this function. Pressing the PROG key or choosing DEL N will stop this function from completing.
DEL O	Deleting all of the measurements stored in an object. The program requires that the user choose the object. The program requires a DEL Y confirmation sequence to complete this function. Pressing the PROG key or choosing DEL N will stop this function from completing.

*c) Displaying, deleting and printing stored Measurements*

After first choosing the "MEM R" function from the memory programming menu, the "MR" icon is displayed. The program displays the measurement value for the last object and the last test saved.

Example: object 1 and test 4 are displayed:





**01 : 04.**  
 OBJ : TEST

The "test" units figure blinks; you can then change the object and test numbers using the arrow keys. The stored measurement value is displayed. Inaccessible objects and tests are those locations that are still available.

When the measurement is viewed, the following measurement components are displayed:

- The number of the object and test that correspond to the memory location.
  - The measurement value with any compensation used.
  - R (θ) display for the type of metal, if the measurement was compensated.
  - The alarms that were active during the measurement.
  - The active range and current levels during the measurement.
- The parameters set for the alarm threshold, reference temperature, ambient temperature and metal correction coefficient are not directly accessible but require a key to be pressed.

Other keys that are active when viewing the memory contents:

	Prints the selected measurement as a ticket
	For compensated measurements, displays the correction coefficient for the chosen metal.
	For compensated measurements, displays the reference temperature value and the ambient temperature level when the measurement was taken.
	For measurements with an active alarm condition, displays the alarm threshold value.



**Before printing:**

Check that the Speed and Parity parameters match in both the unit and printer configuration settings (see sub-section 3.4.6).

Stored measurement printed ticket.

AOIP OM 17	
INSTRUMENT NUMBER:	____
LOW RESISTANCE MEASUREMENT	
OBJECT:	TEST:
DESCRIPTION	
Meas.Date:	__/__/__
Meas.Type	: LOW INDUCTIVE
Metal Type	: Cu
Coeff.Metal	: 3.93
Measurement Temperature	: 23.2 Cel
Reference Temperature	: 20.0 Cel
Resistance value (Tamb)	: 1294.6Ohm
Resistance value ( Tref)	: 1287.2 Ohm
COMMENTS:	
Next test date:	__/__/__

**C.4.8 Programming the temperature compensated measurement Value**

The measured resistance level varies according to temperature and the kind of metal composing it. The "Temperature Compensation" function is used to return the resistance value to the value that it should have at the selected reference temperature level:

$$R(T_{ref}) = \frac{R(T_{amb}) * (1 + \alpha * T_{ref})}{1 + \alpha * T_{amb}}$$

- R(Tamb) → the resistance value measured at ambient temperature
- Tamb → the temperature level measured by a Pt100 probe or programmed by the user
- alpha → the temperature coefficient of the chosen metal (Aluminium, Copper, "Other metal")
- Tref → the programmed reference temperature to which the measurement level is returned

It is also necessary to specify the unit used for displaying the temperature (Celsius or Fahrenheit).

Parameter programming procedure:

- Call up the programming menu. Press 
- To change the reference temperature level, select the Tref command from the menu. Enter a new temperature value or validate the existing one.
- To change the ambient temperature setting, select the next command from the menu, Tamb.  
 PRB : This temperature level can be measured using a Pt100 probe (see sub-section 3.2.6).  
 nPRB : This temperature level is set by the operator. Enter a new value or validate the existing one.
- To change the type of metal, select the next command from the menu, METAL.  
 Cu : The metal chosen is copper.  
 Al : The metal chosen is aluminium.  
 Other :. The metal chosen is any other metal. The alpha coefficient is chosen by the user.
- To change the alpha coefficient, select the next command from the menu, ALPHA. The display will successively show the chosen metal and its temperature coefficient.
- To change the temperature unit, select the next command from the menu, DEG.  
 DEG C : The unit is displayed in Celsius.  
 DEG F : The unit is displayed in Fahrenheit.

- Exit the programming menu. Press  .

- Before performing the measurement, validate the compensation by pressing the  key.

Note: To move around the menus, use the cursor keys, arrow up and arrow down. To select a command or validate a value, press the  key.

## D. CONFIGURATION AND OPERATION COMMANDS USING THE RS232 SERIAL LINK

This section provides the syntax used for configuration and operation commands using the RS232 serial link on the OM 17 microhmmeter.

### D.1 Introduction

- Commands and their arguments are sent in **ASCII** code, without a checksum and end with the **<LF>** character (10 in decimal notation or 0x0A in hexadecimal notation), or the **<CR><LF>** pair (0x0D0A). These commands do not all necessarily receive a reply. As a general rule, the commands that generate a reply by the unit end with a question mark.
- Arguments are separated by commas.
- For numerical arguments, the separator between the decimals is a decimal point.
- If the arguments are incorrect, the unit sets the error code **ERR\_NO** (see **ERR\_NO?** and **ERR?**) and does not reply, if a reply was expected.
- Some commands are only accepted if the unit is in "Remote" mode, as shown in the detailed description (section 4.2).
- Depending on the commands used, the unit uses two types of replies:  
In the case of "short" replies, the data is sent in **ASCII** mode and ends with **<CR><LF>**.  
Longer replies are sent in the form of binary data blocks with a set size, using the following general format:  
**#YXX<binary data> <LF>**  
**Y, XX** are **ASCII** characters.  
**Y** = digit between '1' and '9' indicating the number of digits that make up number **XX**.  
**XX** = is an ASCII number (that can comprise 1 to 9 digits) giving the size in bytes of the **<binary data>** that follows (not including the terminator **<LF>**).  
**<binary data>** = a succession of **XX** bytes that can take any value between 0 and 255.

Example of a reply of this kind: #15 0x04 0x03 0x0A 0x15 0x16 <LF>

The **<binary data>** sent can encode integer or floating point numbers comprising more than one byte. For this kind of data, the bytes are sent "MSB" first.

- Replies in the form of blocks of undefined size are not used in this version, but could be in the future. These blocks only comprise **ASCII** characters and their general form is as follows:  
**#0<CR><LF>**  
**<succession of ASCII characters><CR> <LF>**  
**<succession of ASCII characters> <CR><LF>**  
 ...  
**<LF>**

In this case, the end of the reply is detected by receiving a blank line.

Example of a reply of this type:

```
#0<CR><LF>
REPLY LINE 1<CR><LF>
REPLY LINE 2<CR><LF>
LAST REPLY LINE<CR><LF>
<LF>
```

- **Communication:**
  - Speed: 4800, 9600, 19200 or 31250 baud.
  - One stop bit, no parity.

D.1.1 Command Errors

If the unit does not understand the command received or if its arguments are incorrect, it sets the **ERR\_NO** error code and does not reply even if a reply is called for.

The unit places the successive error codes in a four-element FIFO type memory (where the first error recorded is the first error removed).

The two **ERR\_NO?** and **ERR?** commands are used to obtain the error codes in the order in which they appeared. The **CL\_ERR** command clears the contents of the FIFO.

List of error codes:

<b>ERROR</b>	<b>DESCRIPTION</b>	<b>MEANING</b>
<b>o.</b>		
0	NONE ERROR	No error.
1	UNKNOWN HEADER	Unknown command header.
2	ARG. TOO LONG	Argument too long for the unit.
3	WRONG ARG. NB.	The argument number is the wrong one for the command received.
4	OVERLIMIT ARG.	One of the arguments is outside of the limits allowed for this type of argument.
5	UNKNOWN MNEMONIC	The argument is an unknown mnemonic.
6	WRONG SUFFIX	Suffix error.
7	WRONG ARG. TYPE	One of the arguments is the wrong type for the command received.
8	LOCAL	The unit is in "keyboard active" mode when the command required that it be set to REMOTE mode.
9	WRONG ERROR NO	Wrong error number.
10	CALIBRATION ERROR	Error during calibrating.
11	WRONG ARG.	One of the arguments is incompatible with the command received.
12	NOSTORAGE MEMORY	There is no measurement file in memory.
13	READ MEMORY	Cannot read memory.
14	WRITE MEMORY	Cannot write memory.
15	LIMIT CONF.	The limit configuration is incorrect.
16	CORR. CONF.	The correction configuration is incorrect.
17	WRONG CAL.	Wrong calibration.
18	IMPOSSIBLE ADJUST	Cannot perform adjustment.

## D.2 List of Commands

### GENERAL COMMANDS

\*IDN?  
 PP?  
 REM  
 LOC  
 ERR\_NO?  
 ERR? [<NUMBER>]  
 CL\_ERR

### PROGRAMMING COMMANDS

CFG <TYPEMES>, <RANGE>  
 CFG?  
 LIMIT <NUMSEUIL>, <EN\_HORS>[, <VALSEUIL>[, <UNITE>[, <SENS>[, <BUZZER>]]]]  
 LIMIT? <NUMSEUIL>  
 TCOMPENSATION <EN\_HORS>[, <TREFERENCE>, <UNITE>]  
 TCOMPENSATION?  
 METAL <TYPEMETAL>[, <ALPHA>]  
 METAL?  
 TAMBIAANT <INFOMESURE>[, <VALEUR>, <UNITE>]  
 TAMBIAANT?  
 PROG?  
 LOC\_PROG <ETAT>  
 LOC\_PROG?  
 LG <LANGUE>  
 TITRE\_PRN <TITRE>

### MEMORY USAGE COMMANDS

MEMORY\_STATUS?  
 MEMORY?  
 TEST? <NOOBJET>, <POSITIONTEST>  
 CLR\_OBJECT <OBJET>  
 CLR\_ALL\_OBJECTS

### OTHER INFORMATION COMMANDS

BUILD\_DATE?  
 IDN\_PROGRAM?  
 SOFT\_MINVER?

In the description that follows the commands and their replies, the terminal characters [<CR>] <LF> are implicit and are not mentioned, barring exceptions.

### D.3 General Commands

**\*IDN?**

Description: Unit identification request.  
 Argument : None.  
 Reply : **<Maker>, <Reference>, <SerialNumber>, <VersionPP>**  
 Example : AOIP,OM 17,F01548D23, A.00

**PP?**

Description: Returns the OM 17 program number (or 45150000) followed by the version letter and variant number.  
 Argument : None.  
 Reply : **45150000 <Version><Variant>**  
 Example: 45150000A01

**REM**

Description: Places the unit in remote control mode (locks the OM 17 front panel).  
 Argument : None.  
 Reply : None.

**LOC**

Description: Places the unit in local mode (releases the OM 17 keyboard).  
 Argument : None.  
 Reply : None.

**ERR\_NO?**

Description: Reads the number of the oldest error present in the error FIFO.  
 Note: When the OM 17 unit receives an incorrect command, it records the error number detected in a four-position FIFO. (If this FIFO already contains four error numbers, the oldest one is removed to place the new one). The ERR\_NO? command extracts the oldest error code recorded from the FIFO. If the FIFO is empty, the error number returned is 0 (no error).  
 Argument : None.  
 Reply : **<Error number>**  
 Example: 2

**ERR? [<Number>]**

Description: Reads the meaning of the error number *<Number>*.  
 If *<Number>* is omitted, the OM 17 extracts it from its error FIFO (as described below) and returns its meaning.  
 Reply : **<Number>, <Text explaining error Number>**  
 Example : 2, WRONG ARG

**CL\_ERR**

Description: Clears the error FIFO.  
 Argument : None.  
 Reply : None.

## D.4 Programming Commands

### CFG <ModeMes>, <Range>

Description: Programming the general measurement configuration parameters.

**The unit must be in REMOTE mode**

Argument : **<ModeMes>** measurement mode: inductive = SELF, low inductive = ASELF, auto = AUTO  
**<Range>** MOHM5, MOHM25, MOHM250, MOHM2500, OHM25, OHM250, OHM2500.

Reply : None.

Example : CFG SELF, MOHM250

### CFG?

Description: Reading the general measurement configuration parameters.

Argument : None.

Reply : **<ModeMes>**, **<Range>** (as described above)

Example : CFG?

SELF, MOHM250

### LIMIT <NumSeuil>, <En\_Hors>[, <ValSeuil>[, <Unité>[, <Sens>[, <Buzzer>]]]]

Description: Programming a limit value.

**The unit must be in REMOTE mode**

Arguments :

**<NumSeuil>** 1 or 2

**<En\_Hors>** OFF or ON

**<ValSeuil>** Threshold value

**<Unité>** Unit: OHM, MOHM

**<Sens>** LO or HI

**<Buzzer>** BUZ\_NONE (no buzzer) , BUZ\_LO (low), BUZ\_HI (high).

**Arguments omitted from the command retain their current value**

Reply : None.

Examples : LIMIT 1, ON, 0.246, OHM, HI, BUZ\_LO

LIMIT 1, OFF

LIMIT 1, ON

### LIMIT? <NumSeuil>

Description : Limit (threshold) programming request

Argument : **<NumSeuil>** NumSeuil = 1 or NumSeuil = 2

Reply : **<En\_Hors>**, **<ValSeuil>**, **<Unité>**, **<Sens>**, **<Buzzer>**  
 (as described above).

Example : LIMIT? 1

OFF, 0.246, OHM, HI, BUZ\_LO

### TCOMPENSATION < En\_Hors >[, <Tréférence>, <Unité>]

Description: Programming temperature compensation.

**The unit must be in REMOTE mode.**

Argument : **<En\_Hors>** ON or OFF

**<TRéférence>** Temperature that the measurement is returned to,  
 expressed in the unit **<Unité>**.

**<Unité>** Temperature display unit: CEL (°C) or FAR (°F).

Reply : None.

Example : TCOMPENSATION ON, 23, CEL

TCOMPENSATION?

Description: Temperature compensation parameter request.  
 Argument : None.  
 Reply : **<EnService>** ON or OFF  
           **<TRéférence>** Temperature that the value is brought back to.  
           **<Unité>** Measurement unit, CEL (°C) or FAR (°F).  
 Example : TCOMPENSATION?  
           ON, 23, CEL

METAL <TypeMetal>[, <Alpha>]

Description: Programming the type of metal and the alpha for the OTHER metal.  
**The unit must be in REMOTE mode**  
 Argument : **<TypeMetal>** CU, AL, OTHER ->Type of metal for temperature correction purposes  
           **<Alpha>** Temperature coefficient of the "OTHER" metal, as 10<sup>-3</sup>/°C.  
                           e.g. silver = 3.85 x 10<sup>-3</sup>/°C, enter **3.85**  
**Remark: the Alpha value is only used for "OTHER METAL". If it is entered with the command, it will be saved for "OTHER METAL" but not taken into account for CU and AL.**  
 Reply : None.  
 Example : METAL CU Select copper as the metal  
           METAL OTHER 3.85 Select another metal and its alpha temperature coefficient. For silver, alpha = 3.85

METAL?

Description: Returns the parameters for the selected metal.  
 Argument : None  
 Reply : **<TypeMetal>** CU, AL, OTHER ->Type of metal for measurement purposes  
           **<Alpha>** Temperature coefficient of the OTHER METAL, as 10<sup>-3</sup>/°C.  
 Example : METAL?  
           CU, 3.85 Copper followed by the alpha temperature coefficient of the OTHER METAL.  
           METAL ?  
           OTHER,3.85 OTHER METAL followed by its alpha value.

TAMBIANT <InfoMesure>[, <Valeur>, <Unité>]

Description: Programs the ambient temperature parameters.  
**The unit must be in REMOTE mode**  
 Argument : **<InfoMesure>** MEAS (by the Pt100 probe) or ENTRY (by the user).  
           **<Valeur>** Temperature value entered by the user.  
           **<Unité>** Temperature unit: CEL (°C) or FAR (°F).  
 Reply : None.  
 Examples : TAMBIANT MEAS Temperature measured by the Pt100 probe.  
           TAMBIANT MEAS, 25.1, CEL Ambient temperature measured by the Pt100 probe.  
   Temperature entered, stored, but not taken into account.  
           TAMBIANT ENTRY, 25.1, CEL Ambient temperature entered.

TAMBIANT?

Description: Returns the ambient temperature parameters.  
 Argument : None  
 Reply : **<InfoMesure>** MEAS, measured by the Pt100 or ENTRY, entered by the user.  
           **<Valeur>** Temperature value entered by the user or the last value measured.  
           **<Unité>** Temperature unit CEL (°C) or FAR (°F).  
 Examples : TAMBIANT?  
           MEAS, 24.6, CEL Temperature measured by the Pt100 probe.  
           TAMBIANT?  
           ENTRY, 25.1, CEL Temperature entered.



**PROG?**

Description: Reading the OM 17 binary programming structure.

Argument : None.

Reply : **#214 <PROG binary structure 14 bytes> <LF>**.

The binary programming structure sent back is a succession of 14 bytes described by the structure below.

Within a given byte (BYTE) the bit fields are allocated starting with the LSBs. Consequently in the first byte sent, bits b0 and b1 encode the measurement mode, bits b2 and b3 the type of metal, and so on.

STRUCTURE	BIT	COMMENTS
	MSB	
TypeMes	2	Measurement mode: 1=low inductive, 2=inductive, 3=auto
TypeMetal	2	Cu=1, Al=2, Other=3 ->Type of metal for measurement
Cal	3	Calibration No., from 1 (=5 mΩ) to 7 (=2500 Ω).
CorrectOn	1	1 if temperature compensation in service, 0 if not
SensHaut1	1	Threshold1: Direction down = 0, up = 1
Actif1	1	Threshold1: Threshold inhibited = 0, active = 1
UnitOhm 1	1	Threshold1: Unit mΩ = 0, Ω = 1
Cpav1	2	Threshold1: Number of digits after the decimal point (max. 4)
BuzzerOn1	2	Threshold1: Buzzer None= 0, Low= 1, High= 2.
InfoUnitDeg	1	Temperature display unit Cel = 0, Far = 1
SensHaut2	1	Threshold2: Direction down = 0, up = 1
Actif2	1	Threshold2: Threshold inhibited = 0, active = 1
UnitOhm2	1	Threshold2: Unit mΩ = 0, Ω = 1
Cpav2	2	Threshold2: Number of digits after the decimal point (max. 4)
BuzzerOn2	2	Threshold2: Buzzer None= 0, Low= 1, High= 2.
InfoPt100	1	Tamb: Measured by Pt100 = 1, entered by the user = 0
Unused	8	One byte for UINT alignment
ValSeuil1	16	Value threshold 1
ValSeuil2	16	Value threshold 2
Tref	16	Temperature that the value is returned to (unit = one hundredth of a °C -> 2000 ⇔ 20.0°C)
Tamb	16	Ambient temperature when entered manually
Alpha	16	OTHER metal alpha temperature coefficient, in 10 <sup>-3</sup> /°C
	<b>LSB</b>	

NB:The temperatures Tref and Tamb are expressed in hundredths of a °C, regardless of the display unit byInfoUnitFar.

The value of threshold1 is:  $uiValSeuil1 * 10^{-byCapv1}$

It is expressed in mΩ if byUnitOhm1 is at 0, and in Ω if byUnitOhm1 is at 1.

These remarks apply to threshold2.

**LOC\_PROG <Etat>**

Description: Lock/unlock OM 17 keyboard programming so that the user can only access it using a password, programming remaining possible by PC.

**The unit must be in REMOTE mode**

Argument : **<Etat>** LOCK or UNLOCK.

Reply : None.

Example : LOC\_PROG LOCK

LOC\_PROG?

Description: Queries the OM 17 to determine whether its keyboard is locked or not for access to programming functions. The other commands remain accessible.

Argument : None.

Reply : **<Etat>** LOCK or UNLOCK.

Example : LOC\_PROG?  
LOCK

LG <Langue>

Description : Changes the language used for printing labels by the printer.

Argument : **<Langue>** Language number (French = 0, English = 1).

Reply : None.

Example : LG 0

TITRE\_PRN <Etat>

Description : Changes the title of the printed label.

Argument : **<Strinst>** new title (company name).

Reply : None.

Example : TITRE\_PRN CHECK: VERITAS

### D.5 Memory Usage Commands

In the descriptions that follow, the numbering of the *Objects* and *Tests* runs from 1 to 99.

MEMORY\_STATUS?

Description: Gives the memory usage level.  
**The unit must be in REMOTE mode**

Argument : None.

Reply : **<Occupation>** Percentage of OM 17 memory usage (0 to 100).

Example : 52 (= 52%).

MEMORY?

Description : Gives the number of the last *Object* that contains tests, followed by the number of *Tests* available in each OM 17 *Object* .  
**The unit must be in REMOTE mode**

Argument : None.

Reply : **#YXX <NbObjetsX> <NbTestsO1>< NbTestsO2>..< NbTestsX> <LF>**

- Y Number of digits in the number 'XX' that follows (in ASCII)
- XX Number of bytes that follow (in ASCII)
- <NbObjetX> Number of the last object containing tests (binary byte: 1 to 99 or 0 if no object contains tests)
- <NbTestsO1> Number of *Tests* contained in *Object* 1...
- <NbTestsO2> Number of *Tests* contained in *Object* 2...
- <NbTestsX> Number of *Tests* contained in *Object* <NbObjetX>

Reply examples:

```
#15 0x04 0x05 0x02 0x00 0x03 <LF>
    The last object with tests is object 4
    Object 1 contains 5 tests
    Object 2 contains 2 tests
    Object 3 contains no tests
    Object 4 contains 3 tests
    Objects 5 to 99 contain no tests.

#11 0x00 <LF>
    No object contains tests.
```

TEST? <NoObjet>, <PositionTest>

Description: Reading an object test.

**The unit must be in REMOTE mode**

Argument : <NoObjet> Object number (1 to 99).

<PositionTest> Position in the object of the desired test (1 to 99).

Reply : #218 <TEST binary structure 18 bytes> <LF>

The test's 16 data bytes are described by the following structure:

STRUCTURE	BIT	COMMENTS
	MSB	
NumTest	8	Test number
TypeMes	2	Measurement mode: 1=low inductive, 2=inductive, 3=auto
TypeMetal	2	Cu=1, Al=2, Other=3 ->Type of metal for measurement
Cal	3	Calibration No., from 1 (=5 mΩ) to 7 (=2500 Ω).
InfoPt100	1	Tamb: Measured by Pt100 = 1, meas. entered by user = 0
<b>**For threshold 1**</b>		
SensHaut1	1	Threshold1: Direction down = 0, up = 1
Actif1	1	Threshold1: Threshold inhibited = 0, active = 1
UnitOhm1	1	Threshold1: Unit mΩ = 0, Ω = 1
Cpav1	3	Threshold1 : Number of digits after the decimal point (max. 4)
Depasse1	1	Threshold exceeded = 1, if not = 0.
InfoUnitDeg	1	Temperature display unit Cel = 0, Far =1
<b>**For threshold 2**</b>		
SensHaut2	1	Threshold2: Direction down = 0, up = 1
Actif2	1	Threshold2: Threshold inhibited = 0, active = 1
UnitOhm2	1	Threshold2: Unit mΩ = 0, Ω = 1
Cpav2	3	Threshold2: Number of digits after the decimal point (max. 4)
Depasse2	1	Threshold exceeded = 1, if not = 0.
Correction	1	If correction = 1; if not = 0
ValSeuil1	16	Value threshold 1
ValSeuil2	16	Value threshold 2
Tref	16	Temperature that the value is returned to (unit = one hundredth of a °C -> 2000 ⇔ 20.0°C)
Tamb	16	Ambient temperature when entered manually
Alpha	16	OTHER metal alpha temperature coefficient, in 10 <sup>-3</sup> /°C
Mesure	16	Measurement made (not compensated)
MesureTref	16	Measurement compensated
	<b>LSB</b>	

CLR\_OBJECT <Objet>

Description: Clears all of the *Tests* for an *Object*, and clears the *Object*.

**The unit must be in REMOTE mode**

Argument : <Objet> number (1 to 99) of the *Object* to clear.

Reply : None.

Example : CLR\_OBJET 12

CLR\_ALL\_OBJECTS

Description: Clears all *Objects*.

**The unit must be in REMOTE mode**

Argument : None.

Reply : None.

## D.6 Other Information Commands

### BUILD\_DATE?

Description: Reads the date when the unit entered service (recorded using the SERIAL\_NB command).  
 Argument : None.  
 Reply : **<Date>** service entry date, format DDMMYYYY.  
 Example : BUILD\_DATE?  
 01052001

### IDN\_PROGRAM?

Object : Returns the memory version number, then the on-board program version number.  
 Argument : None.  
 Reply : **<VersionMem>**, **<VersionPP>**  
 VersionMem : Memory version (e.g.: A.00).  
 VersionPP : On-board program version (e.g.: B.02).  
 Example : A.00,B.02

### SOFT\_MINVER?

Object : Returns the minimum version level of the PC program's Dll capable of using the OM 17, based on the memory test arguments, memory organization, etc.  
 Version updated with on-board software.  
 Argument : None.  
 Reply : **<VersionDll>** minimum version level able to run.  
 Example : A.01

## D.7 LOGOM Program

### A.1.1 Installation

This program is used to configure the unit, read the measurements stored in the unit or clear them. It also lets you store on your computer the measurement values read from the unit for subsequent processing or for printing out.

Equipment required:

- A PC compatible computer with a Pentium processor.
- A Windows 95 operating system or higher.
- A 1.4 Mbyte floppy disk drive or a CD-ROM player depending on the media used.
- An RS232 link for communicating with the unit.

Place the LOGOM program diskette or the CD-ROM into the appropriate drive. Run the "setup" command found on the media, then follow the installation instructions. Once installation is completed, restart your computer. To start the application, choose the OM 17 command from the Windows "Start/Programs/AOIP" command path.

### A.1.2 Use

Before communicating with the unit:

Ensure that your PC is connected to the unit using the appropriate cable.

Start the program.

Click on the "connection" icon.

Choose the communication port.

*Ensure that the speed set on the unit is identical to the speed you will be choosing in the program.*

The program's OM 17 menu lets you call up sub-menus to:

Program the unit.

Read the measurements stored in the unit.

Clear the measurements stored in the unit.

The program help function provides any necessary information.

**E. MAINTENANCE**

In view of the necessary precautions and the risks involved, any maintenance operations, including those concerning battery or fuse replacement, should be left to **qualified personnel** only.

**This warning applies particularly to adjustment of the unit, which should be carried out under precise conditions.**

**E.1 Opening/Closing the Unit**

**WARNING:** If a maintenance procedure requires the unit cover to be opened, **ALWAYS** disconnect all of the links with external circuits as well as the mains cord if the unit is charging. Make sure that the unit is switched off.

- Remove the four screws located under the unit.
- Remove the unit from the case.
- Turn the unit over (battery pack upwards).

"Measurement" board:

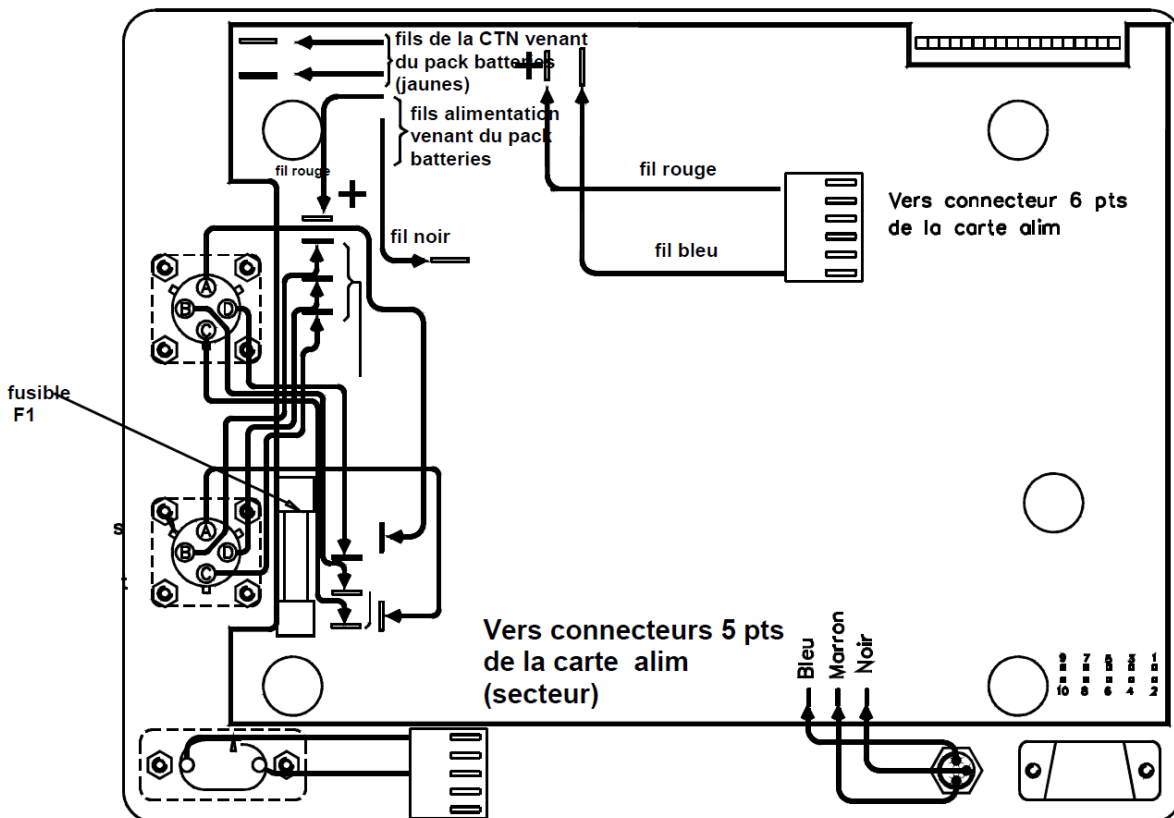

"Power supply" board:

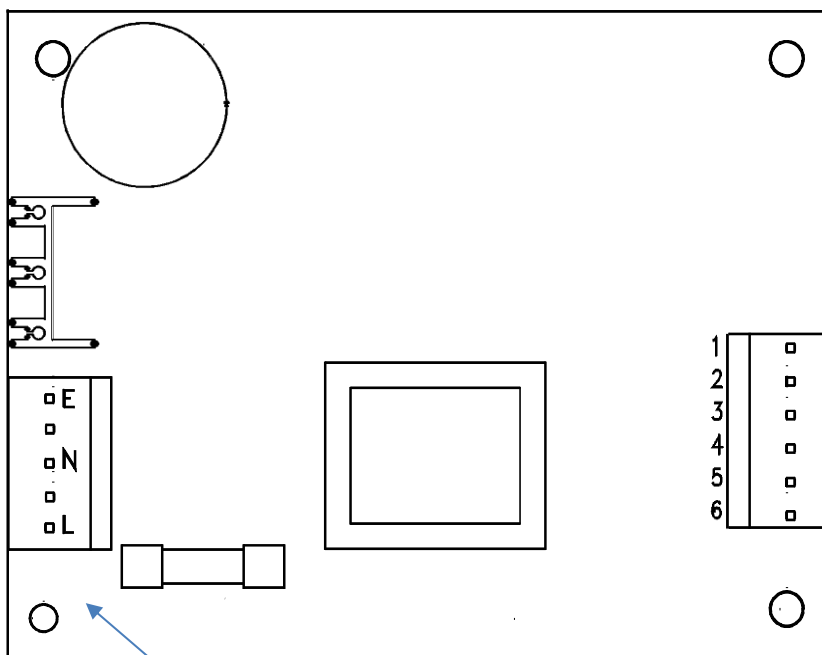
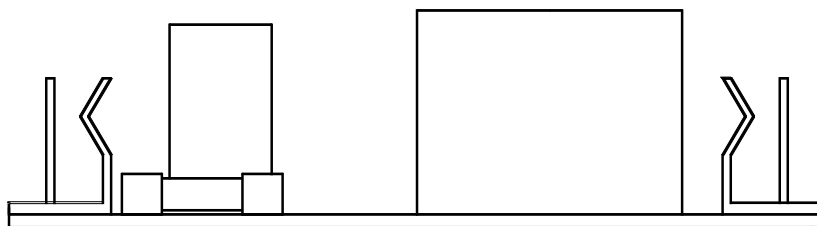

Fusible F2

## E.2 Battery Pack



The battery is composed of five Ni-MH D cell size accumulators (> 8.5 Ah).

### E.2.1 Charging

When the unit displays "Err01" while showing a measurement, or when  appears in stand-by mode, the battery power is low and should be recharged as soon as possible. Fully recharging the batteries takes approximately five hours.  
**WARNING:** Measurements are inhibited during battery charging.

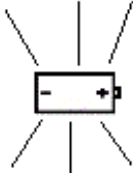

Press the button  during charging and the unit will indicate that:

- it has started a pre-charge: it displays **CHRG L**
- it has started to charge: it displays **batt CHRG** and  blinks.
- it has finished charging: it displays **batt FULL** and .

REMARK:

**WARNING:** If the unit is stored and not used for a lengthy period of time, the charge time required will be increased:

It is therefore essential to maintain the battery by keeping it charged.

**Always avoid storing the unit with a battery charge level that is too low.**

### E.2.2 Replacing the Battery

- Disassemble the unit as described in the previous sub-section.
- Remove the nuts located at the four corners of the metal plate.
- Remove the six- and five-point connectors from the power supply board, along with the wires from the pack. The yellow wires do not have fixed polarities.
- Lift the plate.
- Remove the two screws from the battery pack.
- Replace the battery pack.
- To reassemble the unit, repeat the above operations in reverse order.

**ALWAYS BE SURE to correctly match the connection directions shown in the diagrams.**

## E.3 Fuses

The unit is protected by two fuses:

- Fuse F1, model 6.3x32, fast acting, 16A/250V, low internal resistance, AOIP reference: ER 48306-163, protecting the current source from the application of an outside voltage.
  - Fuse F2, model 5.0x20, fast acting, 2A/250V, AOIP reference: ER 48123-202, protecting the battery charger power supply board.

1. Disassemble the unit as described in sub-section E.1.
2. Remove the faulty fuse and check that it has indeed failed.

Replace it with an identical model of fuse. In any case, if the problem persists, always return the unit to AOIP for checking.



## E.4 Checking Performance

As part of an on-going process of measurement equipment quality control, users may need to perform their own periodic performance checking tests.

These checks must comply with the usual precautions that apply when checking measurement equipment. The following instructions must be complied with.

Handling is performed under reference conditions, i.e.:

- Room temperature:  $23^{\circ}\text{C} \pm 5^{\circ}\text{C}$ .
- Relative humidity: 45% to 75%.

The calibration equipment that makes up the checking system must be such that any errors at the check points are known ones and do not exceed  $\pm 0.01\%$  for resistance calibration levels, after allowing for any influencing factors encountered.

- After the check has been performed, if one or more of the unit's characteristics are found to be outside of the specified tolerances, it is possible to:
- Adjust it in line with the procedure described in sub-section 5.7, which requires having equipment that offers performance at least as good as that used for the check performed previously.

Return the unit to the address shown in sub-section 5.8 for checking and adjusting.

## E.5 Managing Maintenance

In measurement mode, press the PROG key to call up the programming menu. The first function in this menu (SET) is reserved for maintenance use.

This menu is password protected. The password used is a five digit one entered from the keyboard. As delivered ex-factory, this number is set to 09456. Users have the option of changing it at their convenience. After checking the password, a sub-menu offers the following maintenance functions :

LABEL	FONCTION
CPT A	Displays the values of the various calibration adjustment counters.
ADJ	Unit adjustment, refer to sub-section 5.7: "Adjustment".
nCOEF	Clears the adjustment coefficients and uses the default coefficients. Restarting the unit cancels the previous action
UPG	Updates the unit's program, refer to sub-section 5.6: "Updating the On-board Software".
ACCES	Enters a new user password.
FREQ	Chooses the mains power frequency, 50 or 60 hertz.

## E.6 Updating the On-board Software

If any changes are made to the unit, software updates are available from the AOIP website at: <http://www.aoip.fr/> along with a procedure for using them.

The "UPG" function included in the maintenance menu (refer to the Managing Maintenance sub-section) lets you update the unit's program.

After validation, five lines appear on-screen. The unit is now ready to communicate with the computer to download the new program version.

Then follow the instructions displayed on the computer screen.

The transmission speed used for this update function is **19200 baud**. Once the update is completed, the unit initialises just like when it is started up normally.

**Important:** Any shutdown performed without first completing the update will make it impossible to restart the unit. Downloading must be resumed after first replacing the unit in the await transfer mode. To do this, hold the OPER key down for five seconds and restart the unit without releasing the OPER key. The AL1 and AL2 LEDs will blink, then release the OPER key once they have stabilised.

The "await transfer" mode is now active.

## E.7 Adjustment

### RECOMMENDATIONS

The unit has been adjusted in our works. Any inadvertent operation will irreversibly modify the unit's adjustments.

The authority responsible for the usage of this unit must be sure that the person in charge of the adjustment is well advised of the precautions to be taken before performing this operation.

AOIP recommends returning the unit to their works so that the adjustment can be performed under ideal conditions.

The warranty is lost if these recommendations are not respected.

#### E.7.1 Environment

Temperature:  $23^{\circ}\text{C} \pm 5^{\circ}\text{C}$ .

Humidity: 45% to 75%.

Warming-up: 1 hour.

#### E.7.2 Adjusting the Unit

This operation should only be performed under stable environmental conditions (23 degrees C). The unit must be temperature stabilised as must the reference equipment used. If these conditions cannot be met, it is preferable to return the unit to the factory.

To adjust the unit, you will require reference resistors calibrated with a degree of uncertainty that does not exceed  $1 \times 10^{-4}$ . The reference equipment must accept the corresponding calibration current levels.

Ranges to adjust: Pt100, 5 m $\Omega$ , 25 m $\Omega$ , 250 m $\Omega$ , 2500 m $\Omega$ , 25  $\Omega$ , 250  $\Omega$ , 2500  $\Omega$ .

The measurement range settings are performed at one point.

We recommend reference values in excess of 80% of the calibration full scale range.

Pt100 calibration is not a type of measurement calibration, it is used in the temperature compensation measurements; it must therefore be adjusted too, at two points, at a low point and at a high point. We recommend using reference levels of close to 100  $\Omega$  for the low point and 115  $\Omega$  for the high point, with the lower and upper limits being 98  $\Omega$  and 120  $\Omega$ .

To adjust the range levels, connect the calibration references using the measurement connectors.

To adjust the Pt100 calibration level, connect the calibration references to the probe (see 3.2.6).

Reminder: The maintenance menu is password protected.

Adjusting the 5 m $\Omega$ , 25 m $\Omega$ , 250 m $\Omega$ , 2500 m $\Omega$ , 25  $\Omega$ , 250  $\Omega$ , 2500  $\Omega$  range levels.

1. Call up the maintenance menu.
2. Choose the AdJ command from the menu.  
A sub-menu will open so that you can choose the calibration level to adjust.
3. Choose the range to adjust.
4. Check that your calibration reference is properly connected.
5. Choose AdJ H and enter the calibration reference value.
6. Choose MEAS H, and the adjustment is performed.
7. The -AdJ- message indicates that adjustment has taken place normally.

Adjusting the Pt100 probe measurement.

1. Call up the maintenance menu.
2. Choose the AdJ command from the menu.  
A sub-menu will open so that you can choose the calibration level to adjust.
3. Choose Pt100.
4. Check that your calibration reference is properly connected.
5. Choose AdJ L and enter the calibration reference value.
6. Choose MEAS L, and the low point adjustment is performed.
7. Choose AdJ H and enter the calibration reference value.
8. Choose MEAS H, and the high point adjustment is performed.
9. The -AdJ- message indicates that adjustment has taken place normally.

The following error messages may be displayed during the adjustment procedure:

- Err21 - Range value entered out of limits or out of the calibration range.
- Err22 - Measured value out of limits or too far from the calibration reference value.
  - Err10 – Temperature sensor incorrectly connected or missing.

Note:

In the maintenance menu, the nCOEF function lets you use the default adjustment coefficients.  
The unit has to be restarted in order to cancel the command.

## **E.8 Warranty**

The unit is fully warranted for one year in respect of defects which under proper use may appear in any parts and which are due to faulty manufacturing materials or workmanship, provided that no unauthorised modifications have been made on the unit.

If the unit is not operating correctly, it must be returned to the address below or to your local approved repair center, preferably using the original packaging and accompanied by a clear explanation of the reasons for returning it.

## F. Specifications

### F.1 Applicable Standards

### F.2

#### F.2.1 Safety Class

In accordance with European standard EN 61010-1.  
Category II, pollution 2.  
Rated voltage: 60 V.

**Note 1:** The safety instructions relating to the unit are described in Section 1.

#### F.2.2 EMC Conformity

According to European standard EN 61326, standard environment, non-continuous criterion.  
The unit's performance levels meet the demands of the following norms:

Conducted and radiated emission:

- EN 55022, classe B EN 61000-3-2
- EN 61000-3-3

Immunity :

- EN 61000-4-2 electrostatic discharges
- EN 61000-4-3 radiated fields
- EN 61000-4-5 shock waves
- EN 61000-4-6 conducted disturbances
- EN 61000-4-11 voltage drops
- EN 61000-4-4 bursts

#### F.2.3 Ambient Conditions

In accordance with IEC Publication 359 (national standards NF C 42-600, DIN 43745): operating category I.

Reference range: 23°C ± 5°C, relative humidity: 45% to 75%.

Normal operating range: 0°C to + 50°C, relative humidity: 20% to 80% non-condensing.

Operating range limits: - 10°C to + 55°C, relative humidity: 10% to 80% non-condensing.

Storage and transport range: - 40°C to + 60°C (- 15°C to + 50°C with battery charged).

#### F.2.4 Mechanical Conditions

Sealing according to IEC publication 529 (national standard NF C 20-010):

IP53 = case open.

IP64 = case closed.

Impacts: according to European standard EN 61010-1.

#### F.2.5 Measurement under Reference Conditions

According to IEC publication 485 (national standards NF C 42-630 and DIN 43751).

### F.3 Characteristics

#### F.3.1 General

Stated accuracies are expressed in  $\pm (n\% \text{ Rdg} + C)$  with Rdg = reading and C = Constant expressed as a practical unit. They apply to a unit situated in the reference conditions defined elsewhere in the manual after warming-up for one hour.

#### F.3.2 Resistance measuring function

- 4-wire measurement with compensation of spurious voltages.

Range	Resolution	Accuracy over 1 year	Range	Resolution
5.0000 mΩ	0,1 μΩ	0,05% + 1,0 μΩ	10 A	50 mV
25.000 mΩ	1 μΩ	0,05 % + 3 μΩ	10 A	250 mV
250.00 mΩ	10 μΩ	0,05 % + 30 μΩ	10 A	2 500 mV
2500.0 mΩ	0,1 mΩ	0,05 % + 0,3 mΩ	1A	2 500 mV
25.000 Ω	1 mΩ	0,05 % + 3 mΩ	100 mA	2 500 mV
250.00 Ω	10 mΩ	0,05 % + 30 mΩ	10 mA	2 500 mV
2500.0 Ω	100 mΩ	0,05 % + 300 mΩ	1 mA	2 500 mV

Possible excess over the normal rating:

- Rating 5 mΩ : + 20%
- Rating 25 mΩ : + 20%

These values are dependent on the level of battery charge.

Maximum voltage between the terminals in an open circuit: 7V.

Temperature coefficient from 0°C to 18°C and from 28°C to 50°C:  $\leq 1/10$  of accuracy/°C.

Measuring the ambient temperature for compensation:

- Resolution: 0.1°C.
- Accuracy:  $\pm 0.5^\circ\text{C}$ .

#### F.3.3 Protections

- Electronic protection up to 250 V on the "voltage" wires.
- Fuse protection on the "current" wires.
- Protection against breaking the "current" circuit during inductive resistance measurements.

## F.4 End of Unit Service Life

The electronic unit is a source of environmental pollution when it reaches the end of its service life. We recommend against placing it in an ordinary waste disposal container, but instead using the waste recycling facilities available to you in your city/town. You can also return the unit to us and we will dispose of it in an environmentally friendly way free of charge.

### F.4.1 Waste Generated by the Unit

List of waste classified according to French decree No. 2002-540, published in the Official Journal of France on April 20, 2002.

#### **16.02.14: Waste from electronic equipment**

Electronic circuit boards forming the unit.

#### **16.06.02: Batteries and accumulators (dangerous)**

One NI-MH battery pack.

#### **15.01.02: Packaging**

Unit case in ABS plastic.

### F.4.2 Unit Destruction Procedure

Opening the unit: remove the screws under the unit and pull the complete assembly out from the top.  
Separate the electronic circuit boards.  
Remove the battery pack located on the metal base.

**G. Annexes**



### G.1 Unit Maintenance Programming Diagram

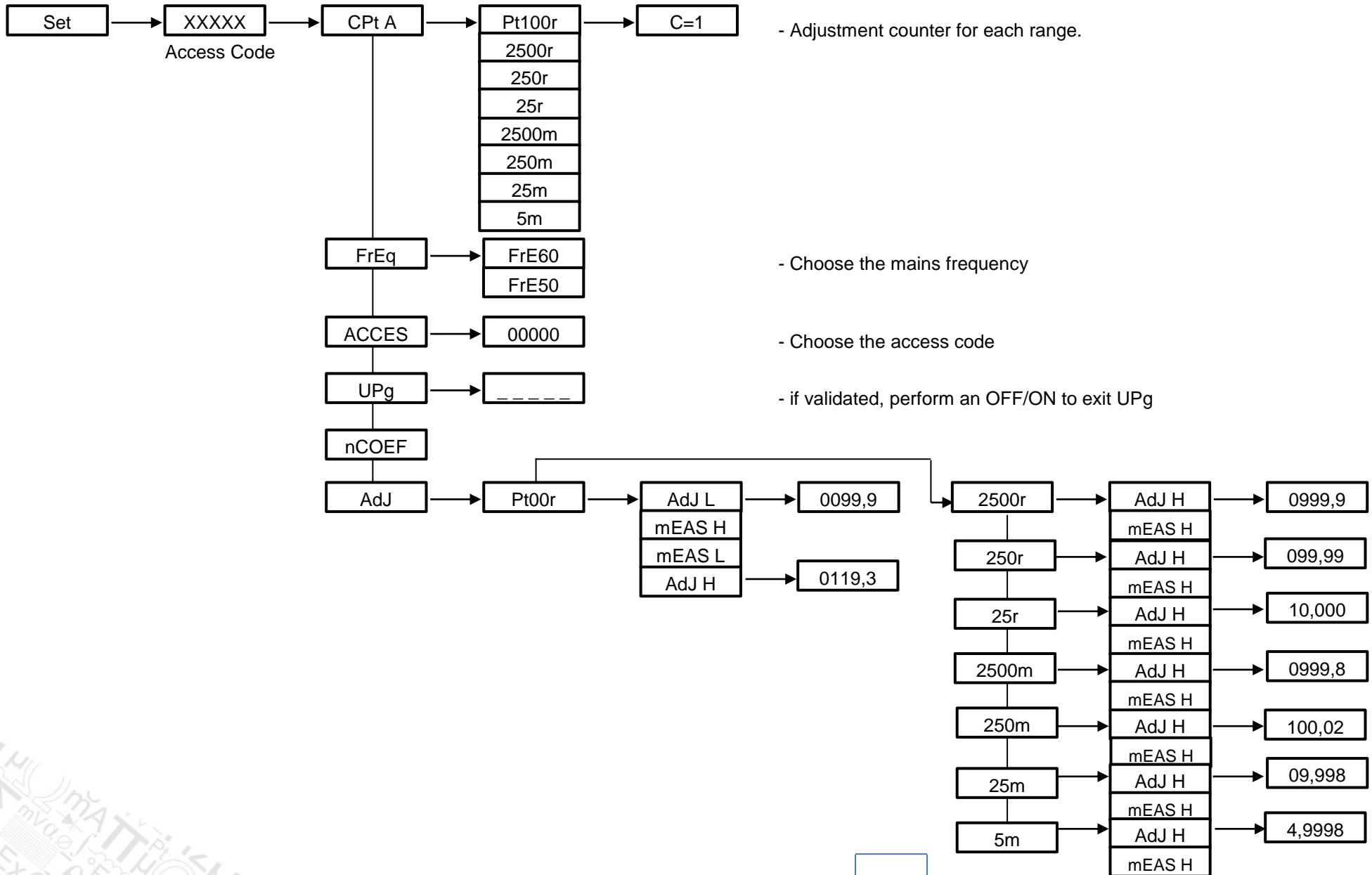

**G.2 Diagramme de programmation et de lecture de l'appareil**

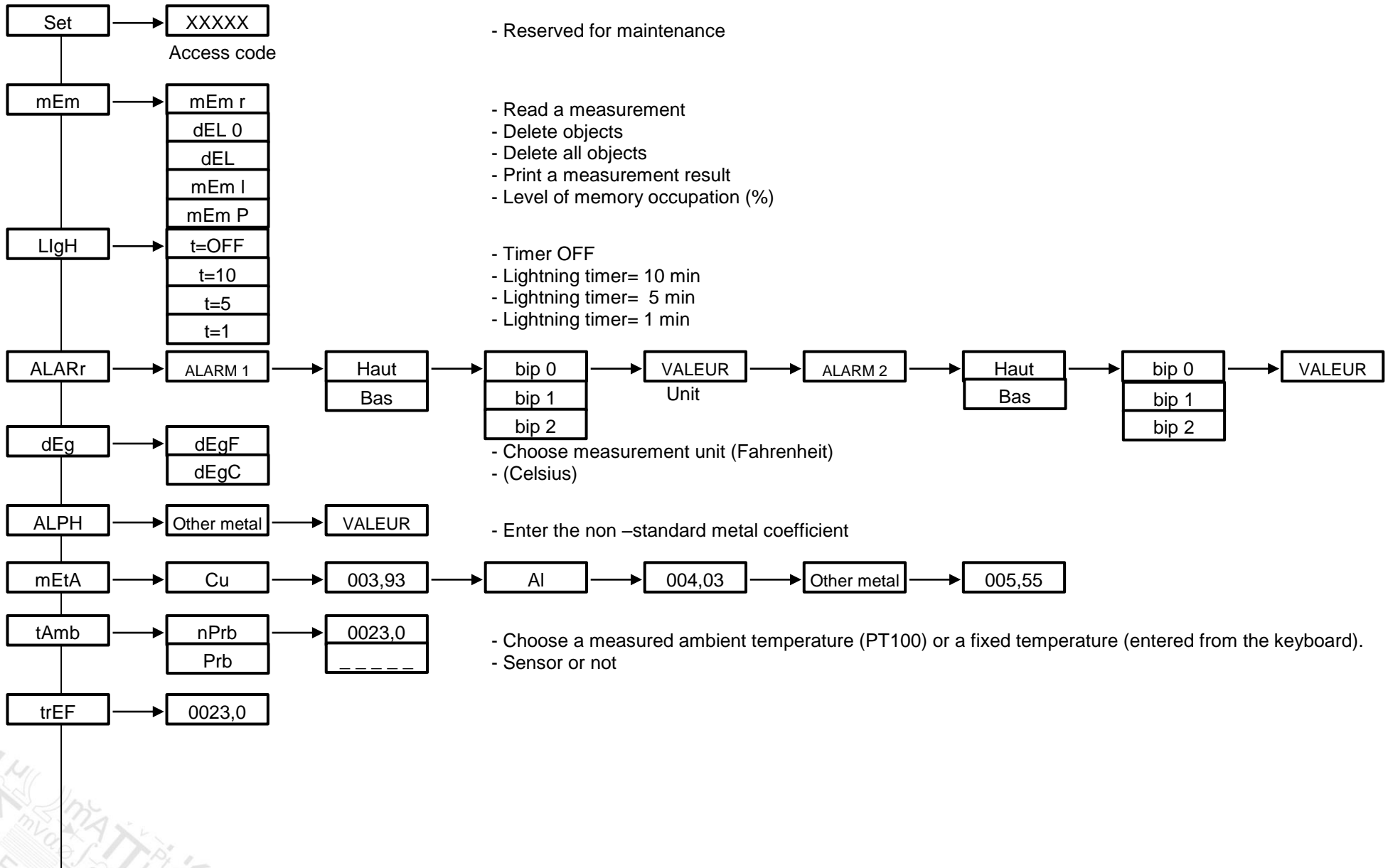

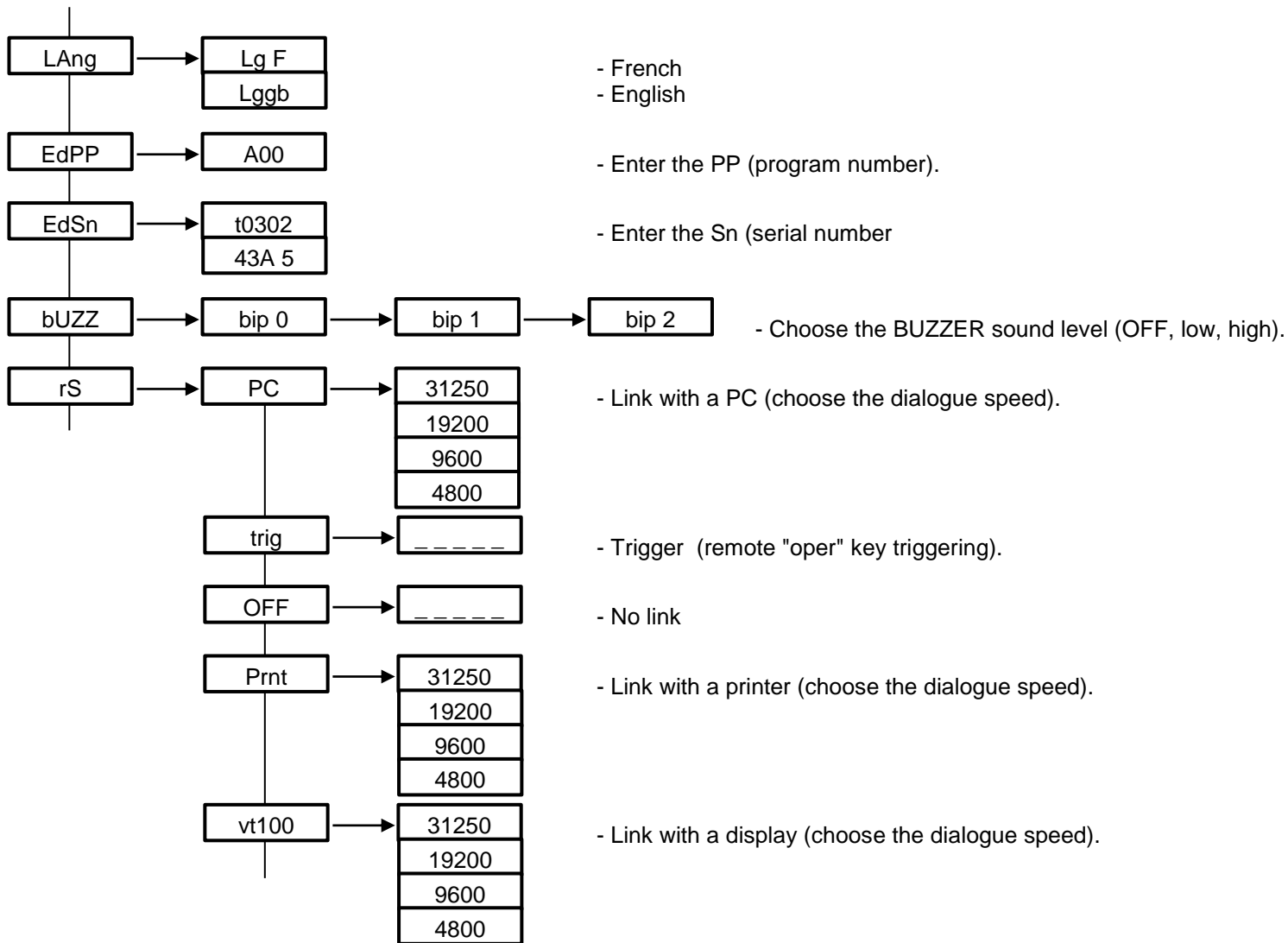





234 Old Weaverville Road • Asheville • North Carolina • 28804  
Phone: (828) 658-3131 • Toll Free: (800) 421-2853 •  
Fax: (828) 658-0728 • Email: [info@palmerwahl.com](mailto:info@palmerwahl.com)  
[www.palmerwahl.com](http://www.palmerwahl.com)