

Technical Datasheet



Sentry Series Differential Pressure Switch

Models: D01, D02 & D03

Key Features

- SPDT & DPDT Switch Outputs
- Aluminium Epoxy Coated Weatherproof Enclosure IP66/NEMA4X
- ATEX / IECEx Intrinsically Safe option
- 316 Stainless Steel Wetted Parts as Standard.
- Field Adjustable Set-points Against a Reference Scale
- Pressure Ranges up to 10bar (160psi)
- Maximum Working Pressure up to 250bar (3500psi)
- Safety Vented Design as Standard
- Suitable for use in SIL 2 safety related systems

Series Overview

The Sentry Series offers exceptional performance and high build quality in a simple, safe and cost-effective package.

- Performance is assured by repackaging Delta's well proven sensor technologies in a new, simple, one-piece enclosure.
- Commissioning is made simple by the inclusion of a hinged lid that is held in place by a single captive screw.
- Safety is maintained by a vent that prevents the enclosure becoming pressurized in the event of a sensor being damaged.
- Cost is minimised through the selection of common standard options although, as with all Delta products, a variety of optional extras are available to tailor the product to specific needs.

Other products in the series include:

- Pressure Switches: Model P0
- Temperature Switches: Model T0



Product applications

The Sentry Series is suitable for a wide range of applications in:

- Process plants
- OEM equipment

The choice of models available ensures that the Sentry Series is suitable for use in:

- General purpose applications
- Zone 0 Hazardous Areas
- SIL 2 safety related systems

How can we help you?

Delta Controls' offers fast, efficient and knowledgeable support when and where you need it. Please visit our web site at www.delta-controls.com to find your local support centre or call us on:

+44 (0) 1252 729140

Sentry Series
Models: D01, D02 & D03

How to order

Switches can be configured by selecting codes representing the desired features from the tables that follow. The chart below, describes how the model code is built up. For assistance in configuring a switch that best suits your needs, please contact your local sales office.

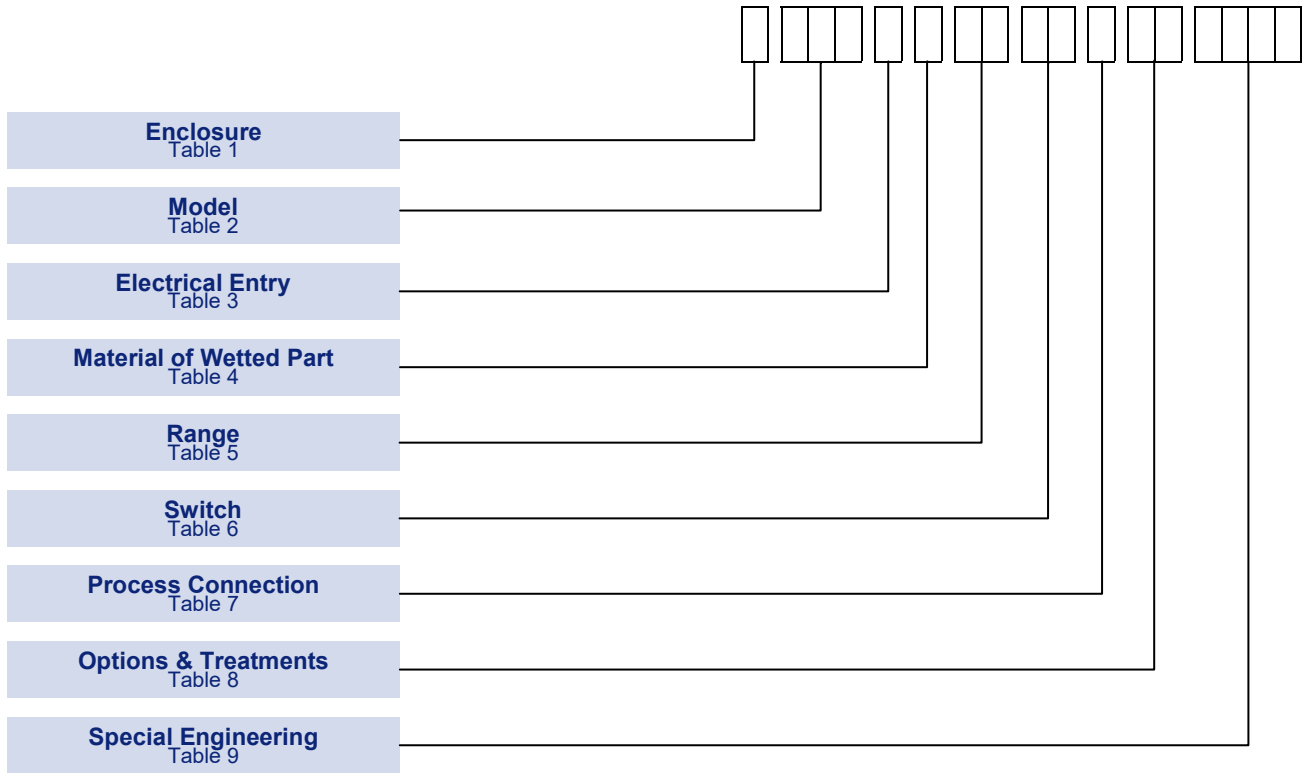

NOTE: Options shaded in the following tables are the most common options and are available on the quickest lead-times and at the lowest cost.

NOTE: Only the most common options are shown in this data sheet. Should you require a feature that is not shown, please contact your local sales office for further details.

Technical Specification

Sentry Series Models: D01, D02 & D03	Accuracy:	Set point repeatability $\pm 1\%$ of span at 20°C / 68°F
	Storage Temperature:	-40 to +60°C / -40 to +140°F
	Ambient Temperature:	-30 to +60°C / -22 to +140°F
	Maximum Process Temperature:	Subject to appropriate installation practice, the component parts with stand up to +60°C (+140°F).
	Enclosure classification:	IP66 / NEMA 4X / Intrinsically Safe Ex ia
	Switch output:	SPDT or DPDT snap action microswitch (standard) Hermetically sealed (optional)
	Electrical rating:	See Table 6
	Process Connection:	Rc ¼ (¼ BSP Tr INT) to ISO 7/1 (standard) ¼ -18NPT INT (optional) Others via adapter optional)
	Approximate Weight:	4.0kg/8.8lb to 8.6kg/19lb depending on model

Enclosure

TABLE 1 

WEATHERPROOF ENCLOSURE	Code
General Purpose The basic enclosure is die-cast in aluminium, epoxy painted, with weather protection not less than NEMA type 4X, IP66.	W
Intrinsic Safety: Ex ia As per General Purpose enclosure above but ATEX and IECEx approved for use in Zone 0 & Zone 20 hazardous locations.  II 1GD Ex ia IIC T5/ T6 Ga (-60°C≤Ta≤+80°C) / (-25°C≤Ta≤+60°C) Ex ia IIIC T135°C Da (-60°C≤Ta≤+80°C)	5

Models

- D01**
 For applications between -12.5mbar to 12.5mbar (-5.0 to 5.0 in H2O), maximum working pressure 1 bar (14.5 psi).
- D02**
 For applications up to 10 bar (160 psi), maximum working pressure 110 bar (1600 psi).
- D03**
 For applications up to 10 bar (160 psi), maximum working pressure 250 bar (3500 psi).

TABLE 2 

		Code
Differential Pressure	Diaphragm Operated Low Pressure	D01
Differential Pressure	Diaphragm Operated Standard Pressure	D02
Differential Pressure	Diaphragm Operated High Overload Pressure	D03

Electrical Entry

TABLE 3 

Description	Code
M20 x 1.5 Internal ISO Thread	0
½ NPT Internal Thread	2

Material of Wetted Parts

TABLE 4 

Ranges		Code
BD-EA	316 Stainless steel diaphragm. All other wetted parts fully austenitic 300 series stainless steel, PTFE and Nitrile seals.	I
BD-EA	Wetted parts Monel diaphragm, fully austenitic 300 Series stainless steel, P.T.F.E. and Viton seals all conforming with Sour Gas or Sour Crude applications as laid down in NACE standard MR 01-75.	L
BC	Nitrile diaphragm and seal with aluminium flanges	D

Sentry Series
Models: D01, D02 & D03

Setting Ranges

The instruments will sustain, without loss of performance, a continuous forward over pressure equal to the maximum static pressure and/or full Vacuum

NOTE: For pressure difference switches maximum working pressure (*P_{max}*) and maximum static/line pressure mean the same.

* Forward overpressure is limited to 500 mbar

Maximum static/line pressure applied in the reverse direction (i.e., to low pressure connection with high pressure connection open to atmosphere) will be contained without failure. The diaphragm on ranges BD to EA (BY to EH) will however have been distorted, leading to a degradation of performance and a shortening of the service life.

TABLE 5

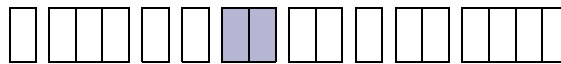

Model	Range				Deadband**	
	mbar/bar	Code	in H2O/psi	Code	mbar	in H2O/psi
D01	-12.5 to +12.5	BC*	-5.0 to +5.0	BU*	2	1.2
D02	6 to 40	BD	2.5 to 16	BY	5	2.0
(D03)		(0D)		(0Y)		
D02	25 to 160	CB	10 to 64	CS	16	6.4
(D03)		(0B)		(IS)		
D02	100 to 600	CE	1.5 to 8.5	CK	22	0.3
(D03)		(0E)		(0K)		
D02	0.4 to 2.5	DC	6 to 40	DP	120	1.7
D03						
D02	0.6 to 4	DD	10 to 60	DT	210	3.0
D03						
D02	1.6 to 10	EA	25 to 160	EH	420	6.1
D03						

** Deadband figures are typical for Code 10 SPDT 15A microswitches (see table 6) with falling set-points at mid-scale. Deadbands for other microswitch options may differ. Due to manufacturing tolerances the figures quoted are for guidance only. Should the differential be critical for specific applications, our engineers should be consulted before ordering.

Switch Options

TABLE 6

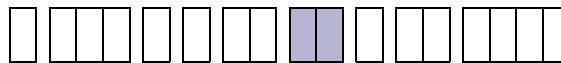

CSA Rating (RESISTIVE) §SEE NOTE	IEC 947-5-1/EN 60947-5-1 RATING							Contact	Code
	Designation & Utilization Category	Rated operational current I _e (A) at rated operational voltage U _e	U _i	U _{imp}	VA Rating				
					Make	Break			
5 A @ 110/250V AC Light Duty for AC only	AC14 D300	0.6/0.3A @ 120/240V AC	250V	0.8kV	AC	432	72	SPDT	00
	DC13 R300	0.22/0.1A @ 125/250V DC			DC	28	28	DPDT	01
1 A @ 125V AC & §100 mA @ 30V DC gold alloy contacts for low voltage switching	1 A @ 125 VAC RESISTIVE (IEC 1058-1/EN 61058-1)							SPDT	04
								DPDT	05
15 Amp @ 125/250/480 V AC & 2 A @ 30V DC General purpose precision	AC14 D300	0.6/0.3A @ 120/240V AC	250V	0.8kV	AC	432	72	SPDT	10
	DC13 R300	0.22/0.1A @ 125/250V DC	250V	0.8kV	DC	28	28	DPDT	11
5 A @ 250V AC and 2 A @ 30V DC Hermetically sealed. Gold plated silver contacts.	AC14 D300	0.6/0.3A @ 120/240V AC	250V	0.5kV	AC	432	72	SPDT	H2 [†]
	DC13 R300	0.22/0.1A @ 125/250V DC			DC	28	28	DPDT	H3 [†] H6 [‡]

† 2 Single pole, double throw, simultaneous falling under pressure
 ‡ 2 Single pole, double throw, simultaneous rising under pressure
 ^Terminal Block supplied as standard
 Note: For Low energy circuits e.g 30V and up to 100mA, we recommend using gold alloy contact switches
 U_i = rated insulation voltage; U_{imp} = rated impulse to withstand voltage across contacts.
 In the absence of any verification by CSA the microswitch § manufacturer's rating is stated in **italics and bold**.
 If in doubt seek guidance from the factory.

Sentry Series
Models: D01, D02 & D03

Process Connection

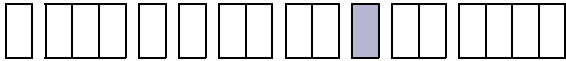
TABLE 7 

	Code
Rc ¼ (¼ BSP Tr INT) to ISO 7/1: Direct	A
¼ NPT F: Direct	F

Options & Treatments

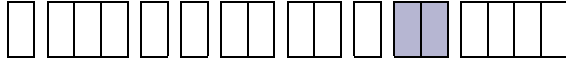
TABLE 8 

	Code
Stainless steel permanently fixed tags	20
Stainless steel wired on tag	30
Applies when – no option is required and selection is made from special engineering (see Table 9)	00

Special Engineering

Last 4 digits of model code only used when special engineering is required.

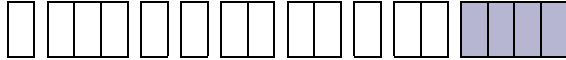
TABLE 9 

	Code
Please consult Delta sales engineering for special requirements	TBA

Performance Data

TABLE 10

Bar Units

FIXED SWITCHING DIFFERENTIAL

Due to manufacturing tolerances, the figures quoted in these tables are for guidance only. Should the differential be critical for specific applications, our engineers should be consulted prior to ordering.

MODELS D01, D02, D03

Code	Range mbar / bar	P _{max} Bar	Microswitch – Option Switching Differential mbar									
			00	01	10	11	04	05	08/ 0G	09/ 0H	H2	H3/ H6
BC	12.5 to 12.5	1	0.6	1	2	2.5	1	1.5	1.8	2.4	2.4	2.4
BD	6 to 40	110 250	1.3	2	4	6	2	3	8	11	10	10
CB	25 to 160	110 250	2.6	4	9	12	4	6	16	21	18	21
CE	100 to 600	110 250	3.3	5	12	15	6	9	20	27	30	32
DC	0.4 to 2.5	110 250	50	75	120	160	70	100	300	400	200	270
DD	0.6 to 4	110 250	60	90	210	270	90	140	360	480	350	480
EA	1.6 to 10	110 250	120	180	420	540	180	250	720	960	800	1200

Sentry Series
Models: D01, D02 & D03

PSI Units

MODELS D01, D02, D03

Code	Range ins H ₂ O / psi	P _{max} Bar	Microswitch – Option Switching Differential Ins H20 / Psi									
			00	01	10	11	04	05	08/0 G	09/0 H	H2	H3/ H6
BU	-5.0 to +5.0	14.5	0.2	0.4	0.8	1.0	0.4	0.6	0.7	0.9	0.9	0.9
BY	2.5 to 16	1600 3500	0.5	0.9	1.6	2.3	0.8	1.2	3.1	4.3	3.9	3.9
CS	10 to 64	1600 3500	1.0	1.6	3.5	4.7	1.6	2.3	6.2	8.2	7.2	8.2
CK	1.5 to 8.5	1600 3500	0.05	0.07	0.17	0.21	0.08	0.13	0.29	0.39	0.43	0.46
DP	6 to 40	1600 3500	0.72	1.1	1.7	2.3	1.0	1.4	4.3	5.8	2.9	3.9
DT	10 to 60	1600 3500	0.87	1.3	3.0	3.9	1.3	2.0	5.2	7.0	5.1	7.0
EH	25 to 160	1600 3500	1.7	2.6	6.1	7.8	2.6	3.6	10.4	13.9	11.6	17.4

Approvals

EUROPEAN DIRECTIVES



Low voltage Directive (LVD) 2014/35/EU.

Compliant to LVD

Pressure Equipment Directive (PED) 97/23/EC:

This product has a process connection size ≤DN25 and is therefore categorised as Sound Engineering Practice (SEP) under Cat 3.3

ATEX Directive 2014/34/EU



INTRINSICALLY SAFE:

Certificate No. BASEEFA11ATEX0203
EN 60079-0, EN 60079-11

For Zone 0 and 20 models (**Enclosure code 5, see Table 1**)

Ex ia IIC T5 / T6 Ga (-60°C ≤ Ta ≤ +80°C) / (-25°C ≤ Ta ≤ +60°C)
Ex ia IIIC T135°C Da (-60°C ≤ Ta ≤ +80°C)

GLOBAL CERTIFICATION



IECEx Certified

INTRINSICALLY SAFE:

Certificate No. IECEx BAS 11.0104X
IEC 60079-0, IEC 60079-11

Ex ia IIC T5/ T6 Ga (-60°C ≤ Ta ≤ +80°C) / (-25°C ≤ Ta ≤ +60°C)
Ex ia IIIC T135°C Da (-60°C ≤ Ta ≤ +80°C)



Functional Safety Certified

Meets the requirements of IEC 61508-2 for use in SIL 2 safety related systems
Certificate No. Sira FSP 12015/01

Dimensions

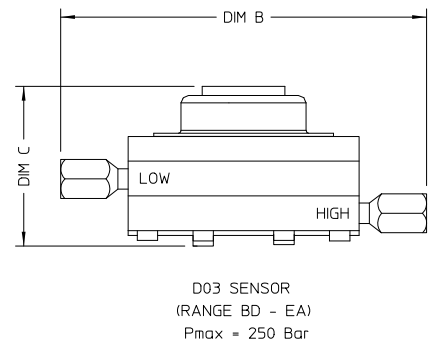
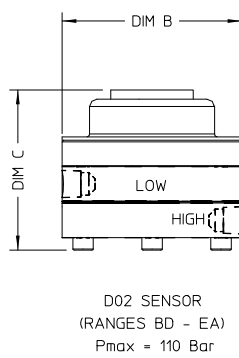
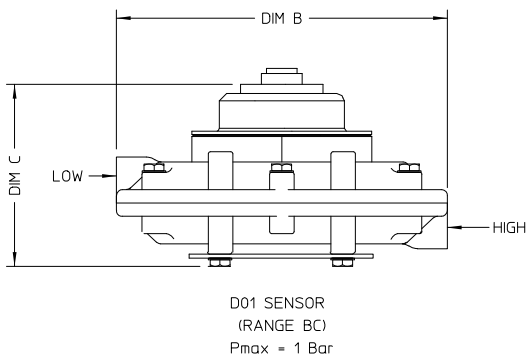
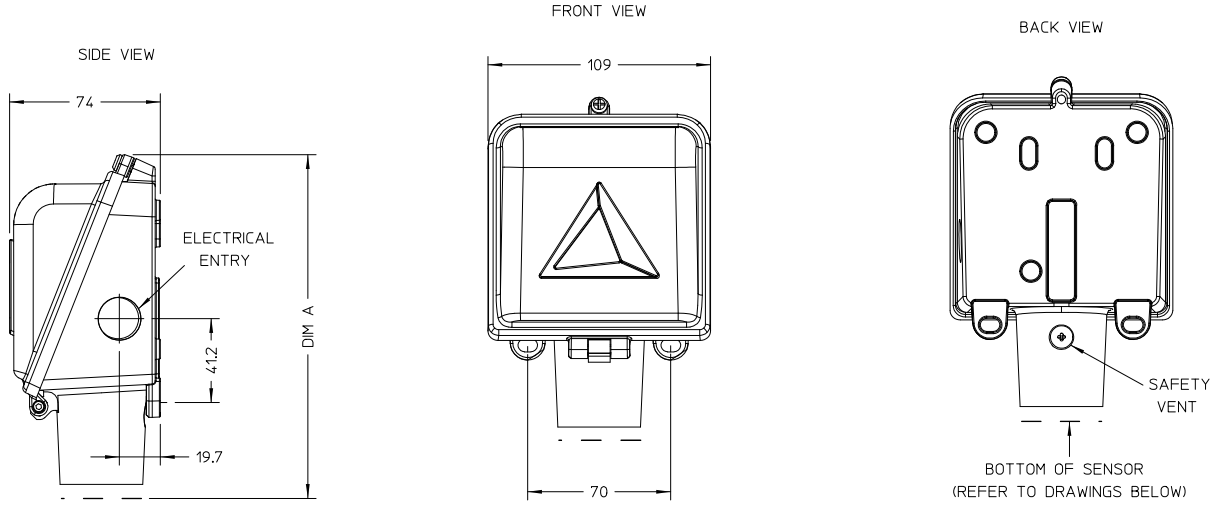

Model	Range	DIM A	DIM B	DIM C
D01	BC	250	162	89
D02	BD - CE	238	114	77
	DC - EA	238	88	77
D03	0D - 0E	263	192	102
	DC - EA	263	166	102

In the interest of development and improvement Delta Controls Ltd, reserves the right to amend, without notice, details contained in this publication. No legal liability will be accepted by Delta Controls Ltd for any errors, omissions or amendments.

Delta Controls Limited
Riverside Business Park, Dogflud Way, Farnham, Surrey GU9 7SS, UK.
T+44 (0)1252 729140 F+44 (0)1252 729168 E sales@delta-controls.com W www.delta-controls.com



FM00720