

# APLISENS<sup>®</sup>

## USER'S MANUAL

SMART PRESSURE AND  
DIFFERENTIAL PRESSURE TRANSMITTERS

**PCE-28.MODBUS, PRE-28.MODBUS,  
PCE-28.MODBUS16, PRE-28.MODBUS16**

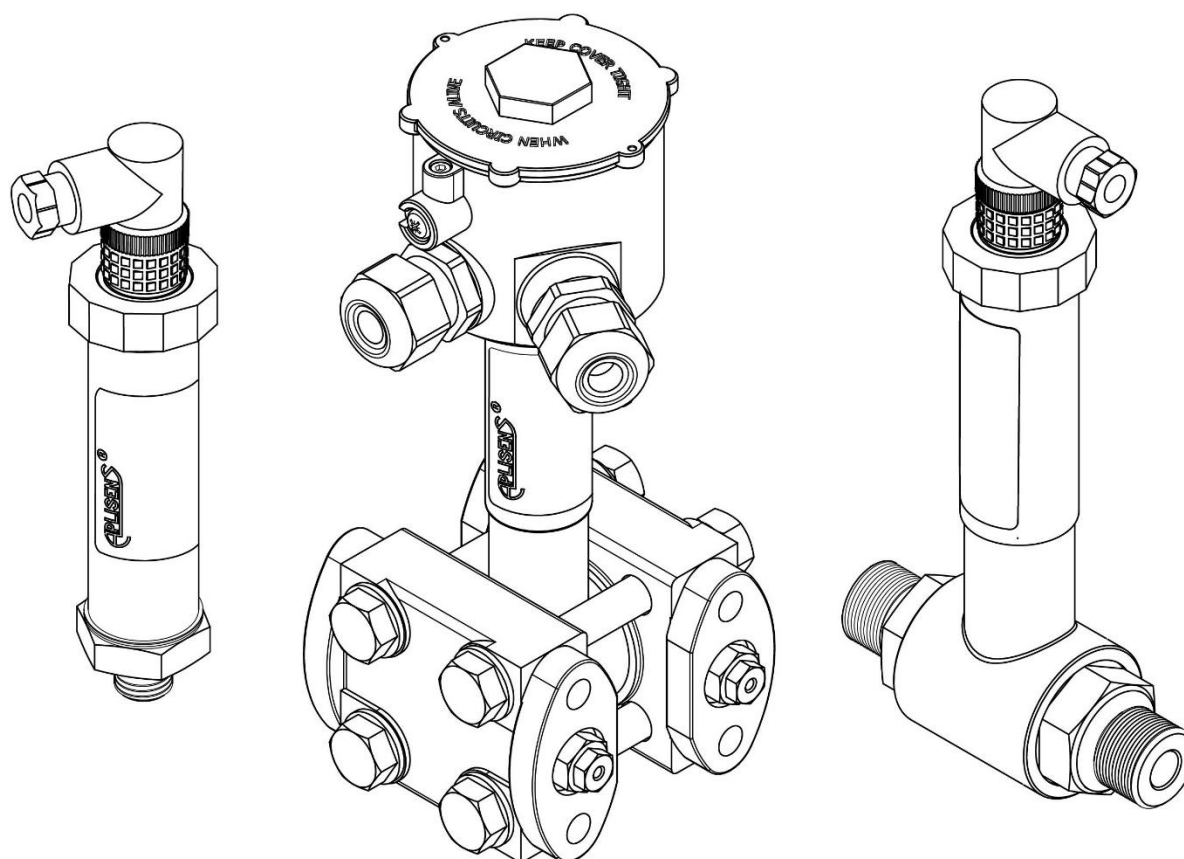

PRODUCT CODE – see: (→ [Transmitter identification](#)).

The QR code or ID number identifies the transmitter and provides quick access to the following documentation on the manufacturer's website: user's manual, explosion-proof device user manual, declarations of conformity and copies of certificates.

## PCE-28.MODBUS

ID: 0032 0001 0001 0000 0000 0000 0001 16

<https://www.aplisens.pl/ID/003200010001000000000000000116/>

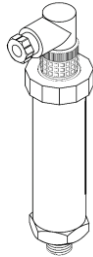

## PCE-28.MODBUS (Exi)

ID: 0032 0002 0001 0000 0000 0001 0001 33

<https://www.aplisens.pl/ID/003200020001000000000001000133/>

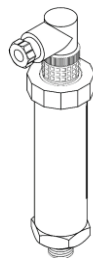

## PCE-28.MODBUS16 (Exi)

ID: 0032 0003 0001 0000 0000 0001 0001 02

<https://www.aplisens.pl/ID/003200030001000000000001000102/>

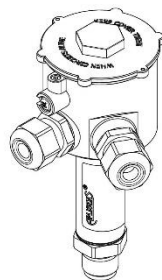

## PRE-28.MODBUS

ID: 0037 0001 0001 0000 0000 0000 0001 98

<https://www.aplisens.pl/ID/003700010001000000000000000198/>

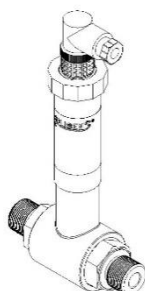

## PRE-28.MODBUS (Exi)

ID: 0037 0002 0001 0000 0000 0001 0001 18

<https://www.aplisens.pl/ID/003700020001000000000001000118/>

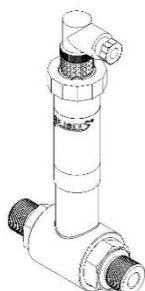



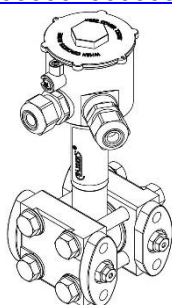

## PRE-28.MODBUS16 (Exi)

ID: 0037 0003 0001 0000 0000 0001 0001 84

<https://www.aplisens.pl/ID/003700030001000000000001000184/>



## Symbols used

Symbol	Description
	Warning to proceed strictly in accordance with the information contained in the documentation in order to ensure the safety and full functionality of the device.
	Information particularly useful during installation and operation of the device.
	Information particularly useful during installation and operation of an Ex type device.
	Information on disposal of used equipment.

### BASIC REQUIREMENTS AND SAFE USE



The manufacturer will not be liable for damage resulting from incorrect installation, failure to maintain a suitable technical condition of the device or use of the device other than for its intended purpose.

Installation should be carried out by qualified staff having the required authorizations to install electrical and I&C equipment. The installer is responsible for performing the installation in accordance with manual as well as with the electromagnetic compatibility and safety regulations and standards applicable to the type of installation.

In systems with I&C equipment, in case of leakage, there is a danger to staff due to the medium under pressure. All safety and protection requirements must be observed during installation, operation and inspections.

If a malfunction occurs, the device should be disconnected and handed over to the manufacturer for repair.



In order to minimize the risk of malfunction and associated risks to staff, the device is not to be installed or used in particularly unfavourable conditions, where the following hazards occur:

- possible mechanical impacts, excessive shocks and vibration;
- excessive temperature fluctuation;
- water vapour condensation, dusting, icing.

Changes made to the manufacturing of products may be introduced before the paper version of the manual is updated. The up-to-date manuals are available on the manufacturer's website: [www.aplisens.com](http://www.aplisens.com).

## TABLE OF CONTENTS

<b>1. INTRODUCTION .....</b>	<b>7</b>
1.1. Purpose of the document .....	7
<b>2. SAFETY .....</b>	<b>7</b>
<b>3. TRANSPORT AND STORAGE .....</b>	<b>8</b>
3.1. Delivery check .....	8
3.2. Transport .....	8
3.3. Storage .....	8
<b>4. GUARANTEE .....</b>	<b>8</b>
<b>5. IDENTIFICATION .....</b>	<b>9</b>
5.1. Manufacturer's address .....	9
5.2. Transmitter identification .....	9
5.3. CE mark, declaration of conformity .....	9
<b>6. INSTALLATION .....</b>	<b>10</b>
6.1. General recommendations .....	10
6.1.1. Installation instructions for transmitters with distance separators .....	10
<b>7. ELECTRICAL CONNECTION .....</b>	<b>11</b>
7.1. Cable connection to transmitter internal terminals .....	11
7.1.1. Connection of transmitters with PKD, PZ, SG, PM12 type connector (cable connection) .....	11
7.2. Transmitter power supply .....	11
7.2.1. Transmitter supply voltage .....	11
7.2.2. Specifications of electrical switching terminals .....	12
7.2.3. Connecting of transmitters in the MODBUS network .....	12
7.3. Equipotential bonding .....	13
7.4. Overvoltage protection .....	14
7.5. Final inspection of cabling .....	14
<b>8. START-UP .....</b>	<b>14</b>
<b>9. OPERATION .....</b>	<b>15</b>
9.1. MODBUS register layout .....	15
9.2. Pressure unit codes .....	16
9.3. Modbus status register description .....	16
9.4. Error codes supported by Modbus .....	16
<b>10. MAINTENANCE .....</b>	<b>17</b>
10.1. Periodic inspections .....	17
10.2. Non-periodic inspections .....	17
10.3. Cleaning/washing .....	17
10.4. Diagram cleaning .....	17
10.5. Spare parts .....	17
10.6. Repair .....	17
10.7. Returns .....	17
<b>11. SCRAPPING, DISPOSAL .....</b>	<b>18</b>
<b>12. HISTORY OF REVISIONS .....</b>	<b>18</b>
<b>Explosion-proof device manual EN.IX.PCE.PRE.28.MODBUS .....</b>	<b>19</b>

## LIST OF DRAWINGS

<b>Figure 1.</b> Diagram of connecting the transmitters in the MODBUS network.....	13
--	----

## LIST OF TABLES

<b>Table 1.</b> Symbols occurring on the transmitter nameplate.....	9
<b>Table 2.</b> Connection, output signals. ....	11
<b>Table 3.</b> Permissible transmitter supply voltages. ....	11
<b>Table 4.</b> A binary value assigned to the corresponding pressure unit. ....	16

## 1. INTRODUCTION

### 1.1. Purpose of the document

The subject of manual are smart pressure transmitters **PCE-28.MOBBUS**, smart differential pressure transmitters **PRE-28.MOBBUS** the manual applies to the standard and intrinsically safe Exi versions and **PCE-28.MOBBUS16**, **PRE-28.MOBBUS16** in intrinsically safe Exi version, hereinafter referred jointly to as the transmitters.

The manual contains data, tips and general recommendations for safe installation and operation of the transmitters, as well as troubleshooting in case of possible failure.  
The manual does not cover explosion protection issues.



It is forbidden to use devices in hazardous areas without appropriate permits.



Data on the transmitters **PCE-28.Modbus**, **PRE-28.Modbus** and **PCE-28.MOBBUS16**, **PRE-28.MOBBUS16** in intrinsically safe version according to ATEX are included in the explosion-proof device manual marked as EN.IX.PCE.PRE.28.MOBBUS

## 2. SAFETY



- The installation and start-up of the device and any activities related to operation shall be carried out after thorough examination of the contents of user's manual and the instructions related thereto;
- installation and maintenance should be carried out by qualified staff having the required authorizations to install electrical and measuring devices;
- the device shall be used according to its intended purpose in line with the permissible parameters specified on the nameplate (→ [Transmitter identification](#));
- the protection elements used by the manufacturer to ensure transmitter safety may be less effective if the device is operated in a manner not consistent with its intended purpose;
- before installing or disassembling the device, it is absolutely necessary to disconnect it from the power source;
- no repairs or alterations to the transmitter electronic system are permitted. Assessment of damages and possible repair may only be performed by the manufacturer or authorized representative;
- do not use instruments if damaged. In case of malfunction, the device must be put out of operation.

### 3. TRANSPORT AND STORAGE

#### 3.1. Delivery check

After receiving the delivery, please refer to the general terms and conditions of contracts available on the manufacturer website: [https://aplisens.com/ogolne\\_warunki\\_umow.html](https://aplisens.com/ogolne_warunki_umow.html).

#### 3.2. Transport

Transport of transmitters shall be carried out with the use of covered means of transport, in original packages with diaphragm provided with protection. The packaging shall be protected against movement and direct impact of atmospheric factors.

#### 3.3. Storage

Transmitters shall be stored in a factory packaging, in a room without vapours and aggressive substances, protected against mechanical impact.

Allowable range of storage temperature:

- PCE-28.MOVBUS: -40 ... 85°C (-40...185°F);
- PRE-28.MOVBUS: -25 ... 80°C (-13...176°F).



Operating temperature range and measured medium for transmitters in the Ex version included in the explosion-proof device manual marked as EN.IX.PCE.PRE.28.Modbus.

### 4. GUARANTEE

General terms and conditions of guarantee are available on the manufacturer's website: [www.aplisens.com/ogolne\\_warunki\\_gwarancji](http://www.aplisens.com/ogolne_warunki_gwarancji)



The guarantee shall be repealed if the device is used against its intended use, failure to comply with user's manual or interference with the structure of the device.



## 5. IDENTIFICATION









### 5.1. Manufacturer's address

APLISENS S.A.  
03-192 Warsaw  
Morelowa 7 St.  
Poland

### 5.2. Transmitter identification

Depending on the version of the transmitter, the nameplates may differ in the amount of information and parameters.

**Table 1.** Symbols occurring on the transmitter nameplate.

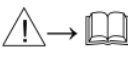
	Logo and name of manufacturer
	CE mark
	CE mark with the number of notified body
	QR code
TYPE:	Transmitter type
ID	Transmitter model ID
	Types of measurement input
 U	Supply voltage values
 T <sub>amb</sub>	Permissible range of ambient temperature
 I	Output signal
El. connection:	Type of electrical connection
Ser.- No.	Transmitter serial number
Year of production	Year of production
IP	IP range value
//lower part of the nameplate//	Special execution
	Note about the read the manual
Aplisens S.A. ul. Morelowa 7, 03-192 Warszawa	Manufacturer address

### 5.3. CE mark, declaration of conformity

The device has been designed to meet the highest safety standards, has been tested and has left the factory in a condition that is safe for operation. The device complies with the applicable standards and regulations listed in the EU Declaration of Conformity and has CE marking on nameplate.

## 6. INSTALLATION

### 6.1. General recommendations



It is recommended that in case of a gaseous medium, the transmitters should be installed above the measuring point so that condensate may flow to the point from which the measured pressure is collected, while in case of liquid medium or steam, it should be installed below the point of pressure intake.

For low measurement ranges, there may be an influence of transmitter's position and influence of impulse lines position and liquid filling method on output signal. Any possible misalignment of the signal should be corrected by resetting the transmitters after mounting.

#### 6.1.1. Installation instructions for transmitters with distance separators

The protection of the separator diaphragm can only be removed shortly before installation. Hydrostatic pressure of the manometric liquid column in the transmitter-separator system may cause incorrect indication of the measured value. After installation, the transmitter must be pressure-reset.

Do not clean or touch separator diaphragms using hard or pointy objects.

Separators with pressure transmitter form a closed, calibrated system filled with gauge fluid. The opening for filling the device with gauge fluid is sealed and must not be opened.



When choosing a mounting location, it is necessary to ensure sufficient stress relief of the capillaries tension in order to avoid excessive bending.

Incorrect installation of the sealing may result in incorrect measurement indications.

Special attention must be paid when selecting correct dimensions of the sealing.



As standard, the separators are not provided with the gaskets.

## 7. ELECTRICAL CONNECTION

### 7.1. Cable connection to transmitter internal terminals



All connection and installation operations shall be performed with disconnected supply voltage and other external voltages, if used.



Failure to provide proper connection of the transmitter may result in danger. Risk of electric shock and/or ignition in potentially explosive atmospheres.

#### 7.1.1. Connection of transmitters with PKD, PZ, SG, PM12 type connector (cable connection)

Electrical connections of transmitters equipped with PKD, SG, PM12 type connectors are made through a terminal box with a gland in which the converter cable connects to the further part of the signal line. The junction box should have a "breathing" hole that equalizes the pressure inside the box to the atmospheric pressure.

**Table 2.** Connection, output signals.

Function	Output of signals		
	Electrical connection		
	PM12 (Connector connection)	PKD,SG (Cable connection)	PZ (Connector connection)
SHIELDED CABLE	1	Green	-
+	2	Red	1
- (GND)	3	Black	2
RS-485 A +	4	Blue	4
RS-485 B -	5	Yellow	3

### 7.2. Transmitter power supply

#### 7.2.1. Transmitter supply voltage



Power cables may be live. There is a risk of electric shock and/or explosion.



Installation of the transmitter in explosion-risk atmospheres must comply with national standards and regulations.

**Table 3.** Permissible transmitter supply voltages.

Mode / version	Minimum supply voltage	Maximum supply voltage
MODBUS mode standard version	4 V DC	28 V DC
Analog mode standard version	5 V DC	28 V DC
MODBUS Exi version for PCE-28.Modbus and PRE-28.MODBUS	4 V DC	10 V DC
MODBUS Exi version for PCE-28.Modbus16 and PRE-28.MODBUS16	10.5 V DC	15.8 V DC

- current for Modbus mode < 3,6 mA for PCE-28.Modbus and PRE-28.Modbus;  
 - current for Modbus mode < 23 mA for PCE-28.Modbus16 and PRE-28.Modbus16.

## 7.2.2. Specifications of electrical switching terminals

Internal electrical switching terminals are suitable for conductors with the cross-section from 0,5 to 2,5 mm<sup>2</sup>.

## 7.2.3. Connecting of transmitters in the MODBUS network

The PCE-28 Modbus, PRE-28 Modbus transmitters have two operating modes:

- configuration mode;
- Modbus mode.

The configuration mode is used to change the settings and for detailed diagnostics of the transmitter. In this mode (in the transmitters manufactured from July 2014 with the software version at least 14 and the electronics version at least 48), the current loop is also activated, which enables operation with a 4-20 mA current output.

If the user intends to use the 4-20 mA operating mode, after configuring the parameters with the "Modbus Configurator" program, the transmitter should be left in the configuration mode.

Additional settings for the 4-20 mA operating mode beyond the scope of the "Modbus Configurator" option are possible with the Raport 2 software.

If the user intends to use the Modbus operating mode, after configuring the parameters with the "Modbus Configurator" program, the transmitter should be switched to the Modbus mode.

The measuring range for 1/100 integer units with a sign is within the range from -32767 to 32767 units. Exceeding this range causes a false reading.

In the case of pressure reading in the "Signed 16-bit int" binary format, the basic unit should be selected in such a way that 100 times the value of the pressure expressed in it does not exceed the above range.

At all baud rates (especially at 115200 bps), a 120 Ω matching resistor should be used, which is by default connected to the transmission system between the "Digital" A and B outputs by means of a jumper (Aplisens PP Modbus boxes are factory-made equipped with a 120 Ω resistor). When connecting products with the MODBUS RTU output signal, it is convenient to use appropriate junction boxes. The Aplisens company proposes to use its own boxes marked with PP-Modbus symbols.

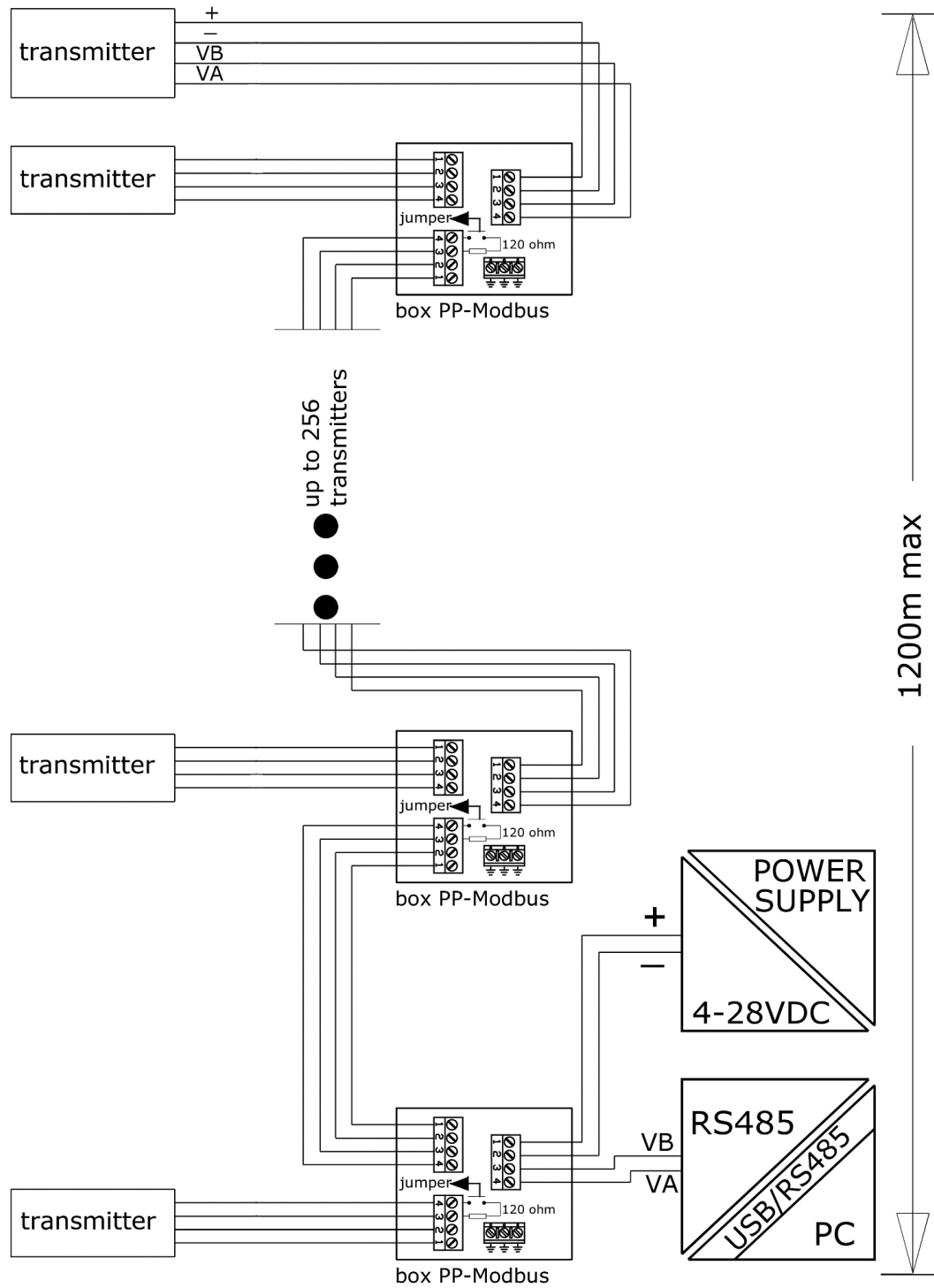

Figure 1. Diagram of connecting the transmitters in the MODBUS network.

### 7.3. Equipotential bonding

In the case of using a cable in the screen, connect the screen on one side at the transmitter's power supply point.

The transmitter in intrinsically version should be powered from a galvanically separated power source or, if this is not possible, equipotential bonding of the transmitter and the power supply device should be ensured by means of equipotential bonding conductors. In this respect the locally applicable regulations must be observed.

## 7.4. Overvoltage protection

Transmitters may be exposed to the effect of switching overvoltage's or those resulting from lightning discharges. Protection against overvoltage's between the wires of the transmission line is provided by TVS diodes installed in all types of transmitters. In order to protect against overvoltage's between the transmission line and the ground or housing (which are not protected by diodes connected between the line wires), additional protection is applied in the form of gas surge arresters. Additionally, an external protective device can be used, e.g. the UZ-2 system by APLISENS or others.

## 7.5. Final inspection of cabling

After completing the electrical installation of the transmitter it is necessary to check the following:

- does the supply voltage measured at the transmitter terminals at maximum set current match the range of supply voltage specified on the transmitter nameplate?;
- Is the transmitter connected according to the information given in section (→ [Cable connection to transmitter internal terminals](#))?;
- Are all cable mount tightened? (depending on the version);
- Are the cable gland tightened? (depending on the version).

## 8. START-UP

As standard, the transmitter is adjusted to a set range equal to the base range, unless a specific set range is provided in the order. The base range and the basic unit of the transmitter can be read out from its nameplate (→ [Transmitter identification](#)).

Description of the communication protocol used in transmitters with Modbus digital output is available on the manufacturer's website in "Modbus Configurator" manual.



Use the transmitter within acceptable pressure limits. Risk of damage due to part breakage when the maximum allowable operating pressure is exceeded.

## 9. OPERATION

### 9.1. MODBUS register layout

Read-only data.

Register	Address (hex)	Purpose	Notes	Format	Bytes (2 bytes per register)
1	0x0000	<b>User specific</b>	% of the controlled set range	IEEE754	4 bytes (2 registers)
3	0x0002	<b>Pressure of sensor 1</b>	Pressure or level process variable	IEEE754	4 bytes (2 registers)
5	0x0004	<b>Pressure of sensor 2</b>	Constant 0°C	IEEE754	4 bytes (2 registers)
7	0x0006	<b>Temperature of sensor 1</b>	Sensor 1 temperature process variable in °C	IEEE754	4 bytes (2 registers)
9	0x0008	<b>CPU temperature</b>	CPU temperature process variable in °C	IEEE754	4 bytes (2 registers)
11	0x000A	<b>Temperature of sensor 2</b>	Constant 0°C	IEEE754	4 bytes (2 registers)
13	0x000C	-----	-----	-----	4 bytes (2 registers)
15	0x000E	-----	-----	-----	4 bytes (2 registers)
17	0x0010	<b>User specific</b>	1/100% of the controlled set range	Signed 16-bit int	2 bytes (1 register)
18	0x0011	<b>Pressure of sensor 1</b>	Integer, 1/100 of the pressure or level unit	Signed 16-bit int	2 bytes (1 register)
19	0x0012	<b>Pressure of sensor 2</b>	Value 0 1/100 of the selected unit	Signed 16-bit int	2 bytes (1 register)
20	0x0013	<b>Temperature of sensor 1</b>	Integer, 1/100°C	Signed 16-bit int	2 bytes (1 register)
21	0x0014	<b>CPU temperature</b>	Integer, 1/100°C	Signed 16-bit int	2 bytes (1 register)
22	0x0015	<b>Temperature of sensor 2</b>	Value 0 1/100 in °C	Signed 16-bit int	2 bytes (1 register)
23	0x0016	<b>Pressure unit</b>	Pressure or level unit	Unsigned 16-bit int	2 bytes (1 register) See Table 4
24	0x0017	-----	-----	-----	2 bytes (1 register)
25	0x0018	<b>Upper sensor limit</b>	Upper limit of the standard range	IEEE754	4 bytes (2 registers)
27	0x001A	<b>Lower sensor limit</b>	Lower limit of the standard range	IEEE754	4 bytes (2 registers)
29	0x001C	<b>Damping value</b> seconds (s)		IEEE754	4 bytes (2 registers)
31	0x001E	<b>Response delay value</b> milliseconds (ms)		Unsigned 16-bit int	2 bytes (1 register)
32	0x001F	<b>Modbus address</b>	1...247	Unsigned 8-bit int	2 bytes (1 register)
33	0x0020	<b>Identity register</b>		Unsigned 8-bit int	6 bytes (3 registers)
36	0x0023	<b>Status register</b>		8-bit flags	2 bytes (1 register)

\*Grayed out fields are not active in the described version of devices

## 9.2. Pressure unit codes

**Table 4.** A binary value assigned to the corresponding pressure unit.

Unit	Value (decimal)	Unit	Value (decimal)
atm	14	mbar	8
bar	7	mmH <sub>2</sub> O (w 4°C)	239
FtH <sub>2</sub> O	3	mmH <sub>2</sub> O	4
g/cm <sup>2</sup>	9	mH <sub>2</sub> O (w 4°C)	171
InH <sub>2</sub> O (w 4°C)	238	mmHg	5
InHg	1	MPa	237
kg/cm <sup>2</sup>	2	Pa	11
kPa	10	psi	6
mbar	12	torr	13

## 9.3. Modbus status register description

15	14	13	12	11	10	9	8	7	6	5	4	3	2	1	0
0	0	0	0	0	0	0	0	0	SV,TV,FV out of limit	PV out of limit	0	0	0	0	0

## 9.4. Error codes supported by Modbus

Error code	Designation	Description
1	Disallowed function code	The error occurs when the function code is unsupported by the device. Currently the function code with number 3 is implemented - Read Holding Registers.
2	Disallowed data address	Error occurs for addresses out of the range 0x00 ÷ 0x23.
3	Incorrect data quantity	Invalid number of read registers declared in frame.
4	Transmitter failure	Hardware fault detected
8	Memory error	A RAM or FLASH error has been detected.



## 10. MAINTENANCE

### 10.1. Periodic inspections

Periodic inspections shall be carried out in accordance with applicable standards. During the inspection, the condition of the pressure (absence of loosened elements and leaks) and electrical (check of connections reliability and condition of gaskets and glands) connectors, condition of separating diaphragms (tarnish, corrosion) and stability of fixing of the housing and mounting bracket (if used) shall be checked. Check the processing characteristics by performing the operations specific for the calibration and possibly configuration procedure described in EN.IM.PCE.PRE.SG.MODBUS.

### 10.2. Non-periodic inspections

If the transmitter at the installation site has been exposed to mechanical damage, pressure overload, hydraulic pulses, overvoltage, deposits, medium crystallization, undercutting of the diaphragm, or incorrect operation of the transmitter is detected, the device should be inspected. Check the condition of the diaphragm, clean it, check the electrical functionality of the transmitter and the processing characteristics.



If there is no signal in the transmission line or its value is improper, check the supply line, connection status on terminal blocks, connectors, etc. Check if the supply voltage and load resistance are correct.

### 10.3. Cleaning/washing

To remove impurities from the external surfaces of the transmitter wipe it with a cloth dampened in water.

### 10.4. Diagram cleaning

The only possible method of cleaning the transmitter diaphragms is to dissolve the sludge produced.



Do not remove deposits and impurities from the transmitter diaphragms, which are formed during operation, mechanically using tools, since the diaphragms and the transmitter can be damaged.

### 10.5. Spare parts

Parts of the transmitter that may be worn or damaged and thus replaced:

- In the transmitter with PKD connection - terminal block with angular cover and gasket;
- In the transmitter with PM12 connection – connector PM12.
- In the transmitter with PKD connection – all connector.
- In the transmitter with PD connection – connector terminal block with angular cover and gasket, and connector base with gasket.



**Other parts in the case of ATEX type of transmitter may be replaced only by the manufacturer or an authorized representative.**

### 10.6. Repair

Faulty or non-operational transmitter shall be provided to the manufacturer.

### 10.7. Returns

In the following cases, the transmitter should be returned directly to the manufacturer:

- need for repair;
- need for factory calibration;
- replacement of improperly selected/shipped transmitter.

## 11. SCRAPPING, DISPOSAL



Worn or damaged devices shall be scrapped in accordance with WEEE Directive (2012/19/EU) on waste electrical and electronic equipment or returned to the manufacturer.

## 12. HISTORY OF REVISIONS

Revision No.	Document revision	Description of changes
-	01.A.001/2021.09	Initial document version. Replaces the revision 1_01.D.011_2020-01. Change of software, power supply, figures. Editorial changes. Prepared by DBFD.
1	01.A.002/2022.01	Updating the parameters according to the new certificate.

# Explosion-proof device manual EN.IX.PCE.PRE.28.MODBUS

PRESSURE/DIFFERENTIAL TRANSMITTERS TYPE:

PCE-28.Modbus, PRE-28.Modbus, PCE-28.Modbus16, PRE-28.Modbus16

INTRINSICALLY SAFE acc. to ATEX

## 1. Introduction

Explosion proof device manual EN.IX.PCE.PRE.28.MODBUS only applies to pressure and differential transmitters PCE-28.Modbus, PRE-28.Modbus. PCE-28.Modbus16, PRE-28.Modbus16 in intrinsically safe version acc. to ATEX marked as in point 2 and the Ex information in the Product Certificate. During installation and use of Ex transmitters it is necessary to use user's manual EN.IO.PCE.PRE.28.MODBUS with „Explosion-proof device manual EN.IX.PCE.PRE.28.MODBUS”.

## 2. Using transmitters in hazardous area.

The transmitters are produced in accordance with the requirements of the following standards:

EN IEC 60079-0:2018, EN 60079-11:2012, EN 50303:2000.

2.1. The PCE-28.Modbus, PRE-28.Modbus transmitters with electrical connection PK, PKM, SG, SGM, PZ may operate in areas where there is a risk of explosion, in accordance with the rating of the explosion protection design:

**I M1 Ex ia I Ma**



**II 1/2G Ex ia IIC T4/T5/T6 Ga/Gb**

**II 2D Ex ia IIIC T110°C Db**

**FTZÚ 18 ATEX 0077X**

2.2. The PCE-28.Modbus, PRE-28.Modbus transmitters with the PKD, PM12 electrical connection are approved only for explosive gaseous atmospheres and have the markings:



**II 1/2G Ex ia IIC T4/T5/T6 Ga/Gb**

**FTZÚ 18 ATEX 0077X**

2.3. The PCE-28.Modbus16, PRE-28.Modbus16 transmitters with PZ, PZ4 electrical connection have the markings:



**I M1 Ex ia I Ma**

**FTZÚ 18 ATEX 0077X**

or



**II 1/2G Ex ia IIB T4 Ga/Gb**

**II 2D Ex ia IIIC T110°C Db**

**FTZÚ 18 ATEX 0077X**

## 3. Permissible input parameters (based on data from the FTZÚ 18 ATEX 0077X)



For the connection of the power supply line and the RS485 data transmission signal line, use devices that have the relevant intrinsic safety certificates, whose parameters must not exceed the permissible input-output parameters given in points a) and b).



The transmitters should be powered from devices with galvanically separated power supply. If it is not possible to separate the galvanically separated power supply, the transmitter or the metal parts connected to it should be properly grounded, using, for example, a system of equalization wires or using an equalization connection between the transmitter and the minus of the power barrier.

3.1. Transmitters PCE-28.Modbus, PRE-28.Modbus with PK, PKM, PKD, PM12, SG, SGM, PZ connection.

Minimum transmitters supply voltage 4 V DC.

The transmitter is an intrinsically safe device with protection level "ia" when the power supply circuit has protection level "ia".

a) Permissible input parameters for power supply (red "+", black "-")

- for power supply with linear characteristics:

$$U_i \leq 10 \text{ V, } I_i \leq 0.4 \text{ A,}$$

EN.IX.PCE.PRE.28.MODBUS

- for power supply with rectangular and trapezoidal characteristics:

$$U_i \leq 5 \text{ V}, I_i \leq 0.4 \text{ A}$$

b) Permissible input and output parameters for RS485 transmission (blue VA, yellow VB):

$$U_i \leq 10 \text{ V}, I_i \leq 0.2 \text{ A}, U_o \leq 10 \text{ V}^*, I_o \leq 0.4 \text{ A}^*$$

\* the output parameters of the transmitters  $U_o, I_o$  are equal to the output parameters  $U_o, I_o$  of the power supply used.

Dependence of temperature class of transmitters on ambient temperature (including temperature of measured medium)  $T_a$  [°C] and sum of power  $P_i$  [W] in power supply circuit and in RS485 transmission circuit is given in **Table Z1**.

Min. ambient temperature  $T_a = -40^\circ\text{C}$  (special version from  $-50^\circ\text{C}$ ).

c) The internal capacitance and inductance of transmitter in the power supply circuit and in the RS485 transmission circuit is:

$$L_i = 0 \text{ } \mu\text{H}, C_i \approx 2.5 \text{ } \mu\text{F}^{**}$$

d) The maximum capacitance and inductance that can be connected to the transmitter in the transmission circuit is for the subgroup:

- IIC  $L_o = 0.2 \text{ mH}, C_o = 0.5 \text{ } \mu\text{F}$ ;
- IIB  $L_o = 0.7 \text{ mH}, C_o = 15 \text{ } \mu\text{F}$ ;
- IIA and group I  $L_o = 1.7 \text{ mH}, C_o = 80 \text{ } \mu\text{F}$ .

\*\* Consider the cable capacitance and inductance, which for a permanently connected cable are:

$$C_k = 0,2 \text{ nF/m} \text{ i } L_k = 1 \text{ } \mu\text{H/m}$$

Transmitter with PK, PKM, PKD, PM12, SG, SGM, PZ connection, input capacitance  $C_w$  and inductance  $L_w$  with cable parameters:

$$C_w = C_i + a \cdot C_k = 2.5 \mu\text{F} + a \cdot 0.2 \text{ nF/m}$$

$$L_w = L_i + a \cdot L_k = 0 \mu\text{H} + a \cdot 1 \mu\text{H/m}$$

Where:

a - the length of the cable permanently mounted in the transmitter in meters.

**Table Z1.** Temperature class dependence on ambient temperature  $T_a$  and power sum  $P_i$ .

$P_i$ [W] Sum of input powers in supply and transmission circuits 485	$T_a$ [°C]	Class temp.	$P_i$ [W] Sum of input powers in supply and transmission circuits 485	$T_a$ [°C]	Class temp.	$P_i$ [W] Sum of input powers in supply and transmission circuits 485	$T_a$ [°C]	Class temp.
0.25	65	T6	0.75	55	T6	1.5	65	T5
	80	T5		80	T5		80	T4
0.5	60	T6	1.2	70	T5	1.75	60	T5
	80	T5		80	T4		80	T4

**3.2.** PCE-28.Modbus16, PRE-28.Modbus16 transmitters with PZ, PZ4 connection:

Minimum supply voltage 10,5 V DC.

a) Permissible input parameters for power supply (“+”, “-“)

- Permissible parameters for power supply for subgroups IIB, IIIC:

$$U_i \leq 15,8 \text{ V}, I_i \leq 1.5 \text{ A}, L_i = 0 \text{ } \mu\text{H}, C_i = 0 \text{ } \mu\text{F}$$

- Permissible parameters for power supply for group I:

$$U_i \leq 15.8 \text{ V}, I_i \leq 2 \text{ A}, L_i = 0 \text{ } \mu\text{H}, C_i = 0 \text{ } \mu\text{F}$$

b) Input and output parameters for transmission RS485 (VA, VB)

$$U_i \leq 10 \text{ V}, I_i \leq 0.5 \text{ A}, P_i = 1,6 \text{ W}, L_i = 0 \text{ } \mu\text{H}, C_i = 2.5 \text{ } \mu\text{F}$$

$$U_o = 5.88 \text{ V}, I_o = 0.039 \text{ A}, P_o = 0.143 \text{ W},$$

$$\text{For gr. I + IIA } L_o = 3 \text{ mH}, C_o = 80 \text{ } \mu\text{F}, \text{ for IIB } L_o = 3 \text{ mH}, C_o = 40 \text{ } \mu\text{F}$$

**4. Connection of transmitters in Ex version**

Connections of the transmitters and devices in the transmitters measuring loop must be made in accordance with intrinsic safety and explosion protection standards and conditions of use in hazardous areas. Failure to observe the intrinsic safety rules may result in an explosion and resultant danger to people.

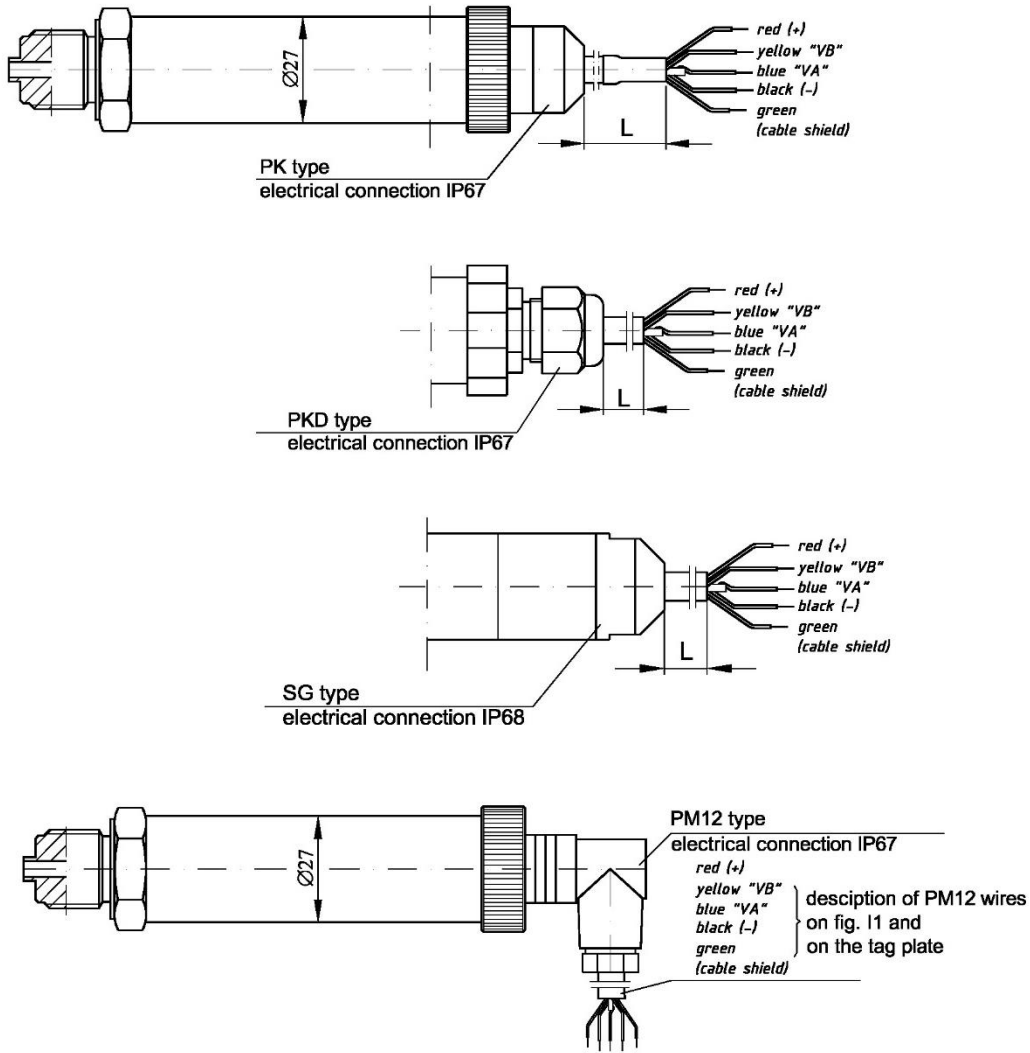

Fig. PK, PKD, SG and PM12 type connection.

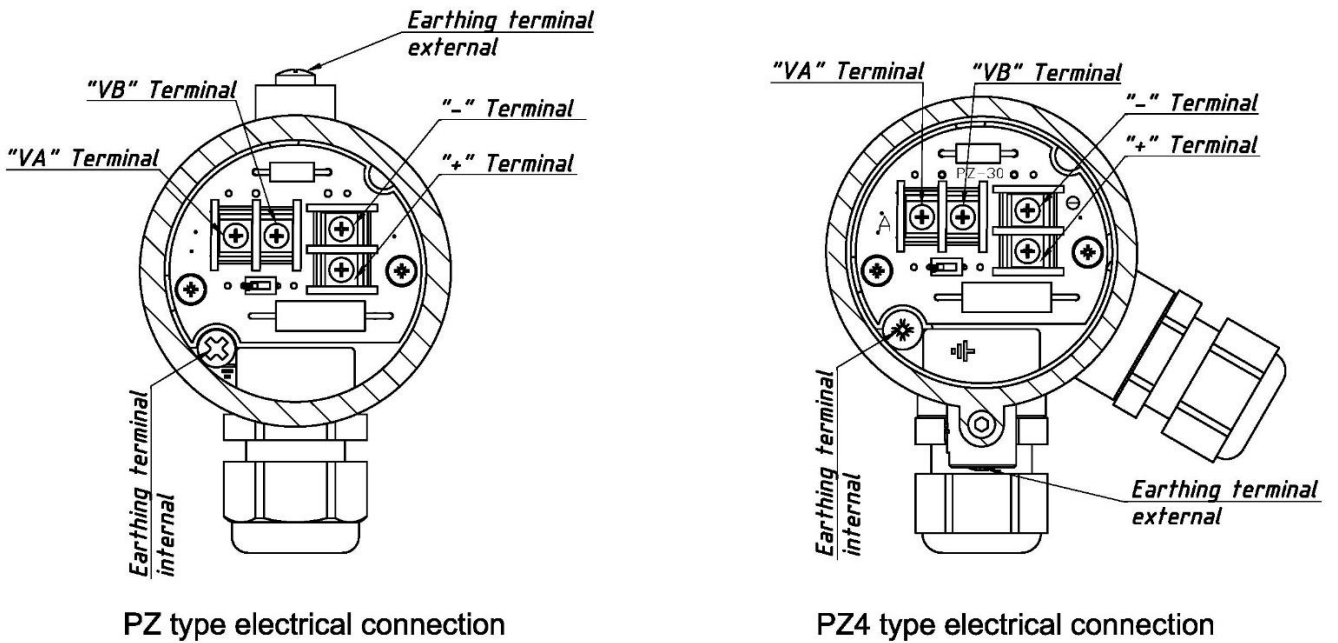

Fig. Type of PZ, PZ4 electrical connection.

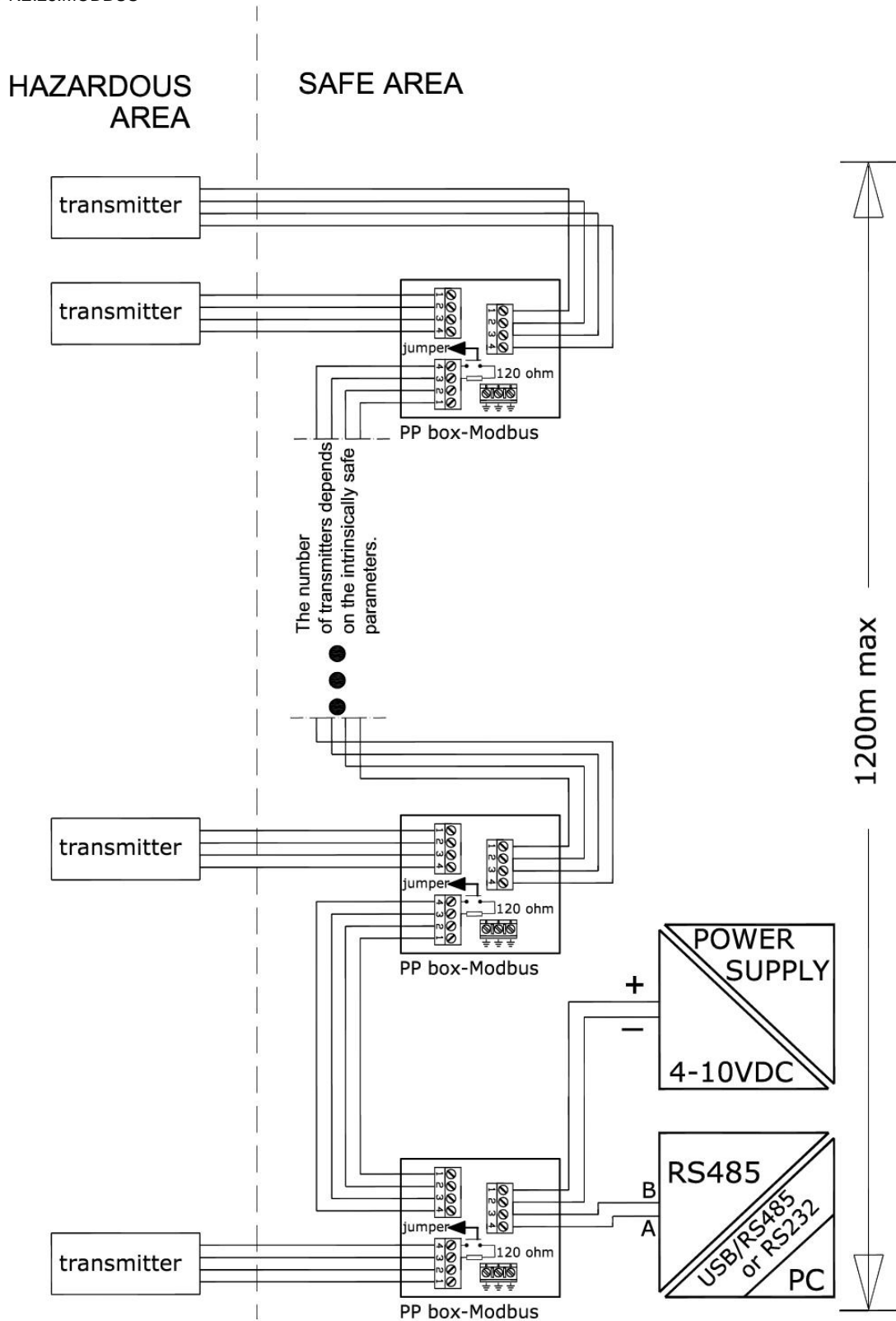

Fig. Diagram of connecting the transmitters in the MODBUS network in Exi version.

The PCE-28.Modbus16, PRE-28.Modbus16 transmitter with PZ, PZ4 type electrical connection has a 560Ω resistor, which can be used as a line/bus terminator. Switching on the resistor can be done using the DIP 1-position switch by switching to the ON position. The number of connectable transmitters with PZ, PZ4 electrical connection to the RS485 bus depends on the intrinsically safe parameters. In the case of a transmitter with a PZ4 connection, not more than 10 pcs.

## 5. Special conditions for safe use

1. The transmitters do not meet the insulation test (500 V rms) required by EN 60079 11:2012. This must be taken into account during installation of the device.
2. For the ambient temperature range, see →[Table Z1](#) as well as the information on the transmitters rating plate.
3. The process (medium) temperature at the diaphragm must be within the ambient temperature range.
4. If titanium parts are used in the separator design, the separator should be protected against mechanical impact during installation and operation of the transmitter.
5. Transmitters with a PTFE coated diaphragm seals, for the III Group, should be installed in places and in a way that prevents electrostatic charging.